

MISSION ROCK INFRASTRUCTURE PLAN

DECEMBER 12, 2017

Prepared by



BKF Engineers
with assistance from the Seawall Lot 337 Association,
CMG, Perkins+Will, Langan Treadwell and Rollo, KPFF, ARUP,
Atelier Ten, Nelson Nygaard Consulting Associates, Moffatt & Nichol,
Evergreen Devco, Nibbi Brothers, Hathaway Dinwiddie,
and Coblentz Patch Duffy & Bass

TABLE OF CONTENTS

1. INTRODUCTION	1
1.1 Purpose	1
1.2 Infrastructure Plan Overview	1
1.3 Property Acquisition, Dedication, and Easements	2
1.4 Project Datum.....	2
1.5 Conformance with EIR & Entitlements	3
1.6 Applicability of Uniform Codes and Infrastructure Standards	3
1.7 Master Plans.....	3
1.8 Project Phasing.....	3
1.9 Phases of Infrastructure Construction	4
2. SUSTAINABILITY	6
3. ENVIRONMENTAL REMEDIATION	7
3.1 Historical Use Background.....	7
3.2 Environmental Constraints and Regulations.....	7
3.2.1 Maher Ordinance Requirements and Site Assessment	7
3.2.2 Use Restrictions	8
3.3 Anticipated Site Remediation Procedures	8
3.2.1 Maher Ordinance Compliance	8
3.2.2 Use Restriction Variance.....	9
4. SITE DEMOLITION.....	10
4.1 Scope of Demolition.....	10
4.2 Existing Utility Demolition	10
4.3 Phases of Demolition.....	11
5. SITE RESILIENCY	12
5.1 Overview.....	12
5.2 Project Datum.....	12
5.3 Federal Emergency Management Agency Regulations	12
5.3.1 Seawall 337, China Basin Park and Terry A Francois Boulevard FEMA Flood Plain Designations.....	13
5.3.2 Pier 48, Pier 50, and Coastal Perimeter FEMA Flood Plain Designation	13
5.4 Sea Level Rise	14
5.4.1 Sea Level Rise Design Guidance.....	14
5.4.2 Sea Level Rise Design Parameters.....	15
5.4.3 Existing Mission Bay Grading for Resiliency.....	16
5.5 Proposed Site and Infrastructure Designs.....	16
5.5.1 Grading	16
5.5.2 Stormwater System	19
5.6 Adaptive Managements Strategies.....	20
5.6.1 Development Parcel Strategy.....	20
5.6.2 Shoreline Adaptation Strategy.....	21

- 6. GEOTECHNICAL CONDITIONS 22
 - 6.1 Existing Site Geotechnical Conditions..... 22
 - 6.2 Existing Site Geotechnical Constraints 22
 - 6.2.1 Liquefaction/ Settlement of Sand Layers 22
 - 6.2.2 Lateral Spreading..... 23
 - 6.2.3 Settlement of Bay Mud 23
 - 6.3 Geotechnical Approaches 23
 - 6.3.1 Site Grading Strategies..... 24
 - 6.3.2 Liquefaction and Lateral Spreading Mitigations 25
 - 6.3.3 Flexible Utility Connections 26
 - 6.3.4 Site Accessibility 26
 - 6.4 Phases of Geotechnical Stabilization 26
 - 6.5 Schedule for Additional Geotechnical Studies..... 27

- 7. SITE GRADING 28
 - 7.1 Project Datum..... 28
 - 7.2 Existing Site Conditions 28
 - 7.3 Site Geotechnical Constraints and Approach..... 28
 - 7.4 Project Grading Overview 28
 - 7.5 Elevation and Grading Design Criteria..... 29
 - 7.5.1 Elevation Design Criteria 29
 - 7.6 Proposed Grading Designs..... 33
 - 7.6.1 Building Areas 33
 - 7.6.2 Proposed Roadways..... 33
 - 7.6.3 Overland Release 33
 - 7.7 Proposed Site Earthwork 34
 - 7.8 Phases of Grading Activities and Approvals..... 34

- 8. STREET AND TRANSPORTATION INFRASTRUCTURE..... 35
 - 8.1 Design Controls: Plan Overview 35
 - 8.2 Public Street System..... 35
 - 8.2.1 Public Street Layout and Parcelization..... 36
 - 8.2.2 Roadway Dimensions 36
 - 8.2.3 Structured Streets and Open Space Areas..... 37
 - 8.3 Public Street Modes of Travel and Access 38
 - 8.3.1 Pedestrian Circulation and Accessibility 38
 - 8.3.2 Vehicular Circulation..... 39
 - 8.3.3 Bicycle Circulation 40
 - 8.3.4 Loading, Servicing, and Parking..... 40
 - 8.3.5 Fire Department Access..... 42
 - 8.4 Public Street Network and Hierarchy..... 42
 - 8.4.1 Street Zones and Designs 43
 - 8.4.2 Street Designs..... 46
 - 8.5 Components of Public Streets 60
 - 8.5.1 Curb Heights..... 60
 - 8.5.2 Paving..... 60
 - 8.5.3 Street Trees 61
 - 8.5.4 Sustainable Water Strategies 63

8.5.5	Lighting	64
8.5.6	Accessible Loading	64
8.5.7	Driveway and Streetscape Coordination	65
8.6	Traffic Calming	65
8.6.1	Raised Intersections and Raised Crosswalks.....	65
8.6.2	Intersection Bulb-Outs	66
8.7	Off-Site Traffic Signalization	66
8.7.1	3rd Street and Existing Terry A Francois Boulevard	67
8.7.2	3rd Street and Channel Street.....	67
8.7.3	3rd Street and Mission Rock Street	67
8.7.4	3rd Street and Exposition Street	67
8.7.5	4th Street Intersection Improvements	68
8.7.6	Mission Rock Street Striping.....	68
8.8	On-Site Traffic Controls.....	68
8.8.1	All-Way Stop-Controlled Intersections: DPW-Standard Curb Condition.....	68
8.8.2	All-Way Stop-Controlled Intersections: Raised Intersections	69
8.8.3	2-Way Stop at Raised Intersection	69
8.8.4	All-Way Stop-Controlled Intersections: Flush Intersections	70
8.9	Public Transportation System.....	70
8.10	SFMTA Infrastructure	71
8.11	Acceptance and Maintenance of Street Improvements	72
8.12	Phasing of New Roadway Construction	72
9.	OPEN SPACE AND PARKS	74
9.1	Open Space	74
9.1.1	China Basin Park.....	74
9.1.2	Mission Rock Square.....	74
9.1.3	The Blue Greenway and the non-pile supported portion of Channel Wharf	74
9.1.4	Channel Street	74
9.1.5	Channel Lane.....	75
9.1.6	Pier 48 Apron and the pile supported portion of Channel Wharf.....	75
10.	UTILITY LAYOUT AND SEPARATIONS	76
10.1	Utility Systems	76
10.2	Utility Layout and Separation Criteria	76
10.3	Conceptual Utility Layout	76
10.4	Utility Layout and Clearance Design Modifications and Exceptions	77
10.4.1	Utility Main Clearance to Face of Curb	77
10.4.2	Utility Structure Type and Clearance to Face of Curb	78
10.4.3	Auxiliary Water Supply System Main within Sidewalk.....	78
10.4.4	Storm Drain Main and Sanitary Sewer Main Layout Order	78
11.	LOW PRESSURE WATER SYSTEM.....	79
11.1	Existing Low Pressure Water System.....	79
11.2	Existing SFPUC System Capacity	79
11.3	Proposed Low Pressure Water System	79
11.3.1	Project Water Supply	79
11.3.2	Project Water Demands	79
11.3.3	Project Water Distribution System.....	80

- 11.3.4 Low Pressure Water Design Criteria 81
- 11.3.5 Proposed Fire Hydrant Locations 81
- 11.4 Phases for Low Pressure Water System Construction 81
 - 11.4.1 Existing Low Pressure Water System Demolition Phasing 82
- 12. SANITARY SEWER SYSTEM 83
 - 12.1 Existing Sanitary Sewer System 83
 - 12.2 Proposed Sanitary Sewer System 83
 - 12.2.1 Proposed Sanitary Sewer Demands 83
 - 12.2.2 Proposed Sanitary Sewer Capacity 84
 - 12.2.3 Proposed Sanitary Sewer Design Basis 84
 - 12.2.4 Proposed Sanitary Sewer Design Criteria 84
 - 12.2.5 Proposed Sanitary Sewer Collection System 85
 - 12.2.6 Structured Street Drainage 86
 - 12.3 Design Modifications and Exceptions 87
 - 12.4 Phases for Sanitary Sewer System Construction 88
 - 12.4.1 Existing Sanitary Sewer System Demolition Phasing 88
- 13. STORM DRAIN SYSTEM 90
 - 13.1 Existing Storm Drain System 90
 - 13.2 Conceptual Storm Drain System Design 90
 - 13.2.1 Overview 90
 - 13.2.2 Storm Drain Design Criteria 91
 - 13.2.3 Conceptual Storm Drain System Layout 92
 - 13.3 Storm Drain System Design Modifications and Exceptions 92
 - 13.3.1 Pipe Material 93
 - 13.3.2 Freeboard and Cover 93
 - 13.3.3 Linear Drainage Infrastructure on Curbless and Flush Curb Streets 93
 - 13.3.4 Storm Drainage Infrastructure on Curbless and Flush Curb Streets 93
 - 13.4 Phases for Storm Drain System Construction 94
- 14. AUXILIARY WATER SUPPLY SYSTEM (AWSS) 96
 - 14.1 Existing AWSS Infrastructure 96
 - 14.2 AWSS Regulations and Requirements 96
 - 14.3 Conceptual AWSS Infrastructure 96
 - 14.4 Phases for AWSS Construction 97
 - 14.4.1 AWSS Phased Installation 98
- 15. DISTRICT UTILITY INFRASTRUCTURE 99
 - 15.1 Central Utility Plant 99
 - 15.1.1 Central Utility Plant Components 99
 - 15.1.2 Central Energy Plant 99
 - 15.1.3 Heat Rejection and Cooling 100
 - 15.1.4 Greywater Collection and Treatment Infrastructure 100
 - 15.2 Phases for District Utility Infrastructure Construction 101
- 16. STORMWATER MANAGEMENT SYSTEM 102
 - 16.1 Existing Stormwater Management System 102
 - 16.2 Proposed Stormwater Management System 102

16.2.1 San Francisco Stormwater Management Requirements & Design Guidelines	102
16.2.2 Proposed Site Conditions and Baseline Assumptions	102
16.2.3 Stormwater Management Design Concepts and Master Plan	103
16.3 Stormwater Control Plan	104
16.4 Phases for Stormwater Management System Construction	104
17. DRY UTILITY SYSTEMS	106
17.1 Existing Electrical, Gas, and Communication Systems	106
17.2 Project Power Providers and Requirements	106
17.3 Proposed Joint Trench	107
17.4 Phases for Dry Utility Systems Construction	107

FIGURES

Figure 1.1	Existing Conditions Plan
Figure 1.2	Conceptual Parcelization
Figure 6.1	Conceptual Location of Flexible Paving and Utilities
Figure 6.2	Conceptual Flexible Utility Connection
Figure 7.1	Existing Grading Plan
Figure 7.2	Conceptual Grading Plan
Figure 7.3	Street Sawtooth Grading
Figure 8.1	Public Realm Plan
Figure 8.2	Conceptual Site Plan & Street Layout
Figure 8.3	Roadway Dimensions
Figure 8.4	Plan View & Cross Sections Locations
Figure 8.5	Typical Street Cross Sections
Figure 8.6	Typical Street Cross Sections
Figure 8.7	Typical Street Cross Sections
Figure 8.8	Typical Street Cross Sections
Figure 8.9	Typical Street Cross Sections
Figure 8.10	Typical Street Cross Sections
Figure 8.11	Typical Street Cross Sections
Figure 8.12	Typical Street Cross Sections
Figure 8.13	Structured Street & Open Space Locations
Figure 8.14	Typical Structured Sheets
Figure 8.15	Pedestrian Circulation + Accessibility
Figure 8.16	Vehicular Circulation
Figure 8.17	Bicycle Circulation + Facilities
Figure 8.18	Loading, Servicing, + Parking
Figure 8.19	Pier 48 Service and Loading
Figure 8.20	Pier 50 Service and Loading
Figure 8.21	Conceptual Fire Truck Turning Analysis
Figure 8.22	Truck Turning Template
Figure 8.23	Truck Turning Enlargements
Figure 8.24	Truck Turning Enlargements
Figure 8.25	Truck Turning Enlargements

FIGURES (Continued)

Figure 8.26	Truck Turning Enlargements
Figure 8.27	Truck Turning Enlargements
Figure 8.28	Street Design
Figure 8.29	Shared Public Way
Figure 8.30	Shared Public Way Plan
Figure 8.31	Terry A Francois Boulevard
Figure 8.32	Terry A Francois Boulevard Plan
Figure 8.33	Bridgeview Street
Figure 8.34	Bridgeview Street Plan
Figure 8.35	Exposition Street
Figure 8.36	Exposition Street Plan
Figure 8.37	Long Bridge Street
Figure 8.38	Long Bridge Street Plan
Figure 8.39	3rd Street
Figure 8.40	3rd Street Plan
Figure 8.41	Mission Rock Street
Figure 8.42	Mission Rock Street Plan
Figure 8.43	Curb Heights Plan
Figure 8.44	Paving Diagram
Figure 8.45	Paving Types
Figure 8.46	Paving Types
Figure 8.47	Urban Forest Diagram
Figure 8.48	Urban Forest Criteria
Figure 8.49	Tree Planting at Structured Street
Figure 8.50	Stormwater Treatment Diagram
Figure 8.51	Stormwater Flow-Through Planter
Figure 8.52	Lighting Diagram
Figure 8.53	Lighting Zones
Figure 8.54	Accessible Loading at Exposition Street
Figure 8.55	Accessible Loading at Terry A Francois Boulevard
Figure 8.56	Accessible Loading at Shared Public Way
Figure 8.57	Typical Driveway Plan
Figure 8.58	Potential Traffic Calming Elements
Figure 8.59	Typical Raised Crossing & Bulb-Out Details
Figure 8.60	Off-Site Traffic Mitigations
Figure 8.61	On-Site Traffic Mitigations
Figure 8.62	Intersection Design Key Plan
Figure 8.63	Typical Intersection All-Way Stop Intersection
Figure 8.64	Typical Raised Intersection
Figure 8.65	Two-Way Stop Intersection
Figure 8.66	Typical Flush Intersections
Figure 8.67	Mission Rock Street Intersections

FIGURES (Continued)

Figure 9.1	Public Open Spaces
Figure 9.2	Phasing
Figure 10.1	Horizontal Utility Main Separation
Figure 10.2	Potential Utility Variance Request Locations
Figure 11.1	Conceptual Low Pressure Water System
Figure 11.2	Typical Utility Section within Public Streets
Figure 11.3	Conceptual Fire Hydrant Locations
Figure 12.1	Conceptual Sanitary Sewer System
Figure 12.2	Typical Utility Section within Public Streets
Figure 12.3	Sanitary Sewer Variance Request Locations
Figure 13.1	Conceptual Storm Drainage System
Figure 13.2	Typical Utility Section within Public Streets
Figure 14.1	Conceptual Auxiliary Water Supply System
Figure 14.2	Typical Utility Section within Public Streets
Figure 15.1	Conceptual Utility District Infrastructure
Figure 15.2	Conceptual Greywater Infrastructure
Figure 15.3	Conceptual Non-Potable Water Infrastructure
Figure 16.1	Conceptual Stormwater Management Plan
Figure 17.1	Conceptual Dry Utility Systems
Figure 17.2	Typical Utility Section within Public Streets

APPENDICES

Appendix A	NOT USED
Appendix B	Hazardous Soil Remediation Plan Letter, September 12 2011
Appendix C	Soil Management Plan, June 1999
Appendix D	Covenant to Restrict Use of Property, recorded January 27, 2000
Appendix E	Covenant to Restrict Use of Property, recorded July 25 2002
Appendix F	Preliminary Geotechnical Recommendations and Summary Memorandum No. 1 (Langan Treadwell & Rollo - January 26, 2016)
Appendix G	NOT USED
Appendix H	District Energy Typical Trench Section
Appendix I	Sea Level Rise Adaptation Strategy, September 6, 2016
Appendix J	NOT USED
Appendix K	NOT USED
Appendix L	NOT USED
Appendix M	District Heating and Cooling Services at Mission Rock May 13, 2016

1. INTRODUCTION

1.1 Purpose

This Infrastructure Plan is an exhibit to the Development Agreement (DA) between Sea Wall Lot 337 Associates, LLC (Developer) and City and County of San Francisco (City), and the Development and Disposition Agreement (DDA) between the Developer and the City, acting by and through the San Francisco Port Commission. The Infrastructure Plan describes the Horizontal Improvements (also referred to herein as Infrastructure), and the Infrastructure improvements to be constructed for the Mission Rock Development Project (Project), associated with Project sustainability, environmental remediation, demolition, grading, street and transportation improvements, open space and park improvements, the potable water system, the sanitary sewer system, the storm drain system, the auxiliary water supply system (AWSS), the central utility plant and eco-district system, the stormwater management system, and the dry utility system.

The Project site includes approximately 28 acres including the existing 14.2-acre Seawall Lot 337, the 0.3-acre lot known as Block P20, the 6.0-acre Pier 48, the 2.2-acre China Basin Park, 3.5-acre Terry A Francois Boulevard, 1.4-acre Pier 48 and 50 access zone, and 0.5-acre of Marginal Wharf. Initially capitalized terms unless separately defined in this Infrastructure Plan have the meanings and content set forth in the DDA and DA.

1.2 Infrastructure Plan Overview

This Infrastructure Plan describes and governs the construction and development of Infrastructure to be provided by Developer for the development of the Project on the Project Site, including known associated off-site improvements needed to support the Project.

The Project infrastructure obligations of the Acquiring Agencies, are described herein, with ownership, maintenance, and acceptance responsibilities of the Acquiring Agencies identified in the DA, DDA, or Memorandum of Understanding (MOU) or Memorandum of Agreement (MOA) per the terms of the Interagency Cooperation Agreement (ICA). A condition of the Developer's performance under this Infrastructure Plan is the obtaining of all requisite approvals in accordance with the DDA, DA and ICA.

1.3 Property Acquisition, Dedication, and Easements

The mapping, street vacations, property acquisition, dedication and acceptance of streets and other Infrastructure improvements is generally anticipated to occur through the subdivision mapping process. Except as otherwise noted, Infrastructure described in this Infrastructure Plan shall be constructed within the public right-of-way or dedicated easements to provide for access and maintenance of Infrastructure facilities.

Public service easements will be allowed within the Project as necessary to provide Infrastructure and services to the Project and are subject to review and approval by the affected City agency. Proposed public water, storm drain, sanitary sewer, recycled water, Auxiliary Water Supply System (AWSS), and power easements benefitting the San Francisco Public Utilities Commission (SFPUC) on Port property will be reviewed on a case-by-case basis. Full access for vehicles and equipment for the maintenance and repair of utility mains will be provided. Public utilities within easements will be installed in accordance with applicable City regulations for public acquisition and acceptance within public utility easement areas, including provisions for maintenance access. Where improvement standards proposed herein differ from the 2015 City and County of San Francisco Subdivision Regulations (Subdivision Regulations), such standards and Infrastructure shall be subject to design modification or exception requests and reviewed by the affected Acquiring Agencies during the Project Phase application or construction document approval process.

1.4 Project Datum

Elevations, including tidal elevations, hydraulic grade lines (HGLs), and site elevations, referred to herein, are based on the Mission Bay Datum (MBD). The MBD is defined as the Mission Bay Datum, which equates to the following:

- The Old City Datum (OCD) plus 100 feet
- The San Francisco Vertical Datum 13 (SFVD13) plus 88.7 feet
- The North American Vertical Datum 88 (NAVD88) plus 88.7 feet

The project will process a design modification or exception for using the MBD in compliance with the Subdivision Regulations.

1.5 Conformance with EIR & Entitlements

This Infrastructure Plan has been developed to be consistent with Project mitigation measures required by the Draft Environmental Impact Report (EIR) and other entitlement documents. Regardless of the status of their inclusion in this Infrastructure Plan, the mitigation measures of the EIR shall apply to the Project.

1.6 Applicability of Uniform Codes and Infrastructure Standards

Future deviations from or modifications to this Infrastructure Plan and/or current City Standards, Guidelines, and Codes are subject to the procedures and provisions of the DA and DDA.

1.7 Master Plans

Each publicly-owned or accepted Infrastructure system described herein will be more fully described and evaluated in Master Utility Plans (MUPs), which will be submitted to the Acquiring Agencies upon substantial completion of the Infrastructure Plan. The MUPs provide detailed layouts of each Infrastructure system. The Infrastructure Plan is to be approved by the Acquiring Agencies as part of the DA and DDA approval processes. Approval of this Infrastructure Plan does not imply approval of the MUPs, which will be approved after DA and DDA execution and prior to submittal of street improvement plans for the first phase of development.

1.8 Project Phasing

It is anticipated that the Mission Rock site will be developed in several phases (Development Phase(s)) subject to the approval process outlined in the DA, DDA, and ICA. Each Development Phase would include a Development Parcel or Parcels and associated Infrastructure and open space areas. Phase Improvements are the street, access, utility and open space improvements necessary to accommodate development of a particular Development Parcel or Parcels.

The parties acknowledge that certain Horizontal Improvements as described in Sections 3, 4, 5, 6, 7 and 8 of the Infrastructure Plan, such as site preparation, removal or remediation of soils, grading, soil compaction and stabilization, may be required or desired at an earlier stage of development and in advance of such Phase Improvements. As described in the DA and/or DDA, the parties will cooperate in good faith in determining the scope and timing of such advance Horizontal Improvements, so as not to delay the construction of Development Parcels and associated Phase Improvements, or affect the criteria for the proportional scope of Phase Improvements.

1.9 Phases of Infrastructure Construction

The construction of Infrastructure, as described in the Infrastructure Plan, tentative map and other Project approvals, will be phased to serve the incremental build-out of the Project in accordance with the Project approvals. Phase Improvements will be described in subsequent improvement plans and associated public improvements agreements or permits approved prior to filing a Final Map for the associated Development Parcels.

For each Development Parcel proposed for development, the associated adjacent and as needed Infrastructure to provide access and utilities to serve that development, such as streets, and improvements therein and thereon, will be constructed. As described in the DDA and DA, adjacent Infrastructure refers to Infrastructure that is necessary and near to and may share a common border or end point with the proposed Development Parcel or Parcels.

Phase Improvements may include Infrastructure on Port or City property outside of the present Phase boundary within a subsequent Phase area. The Acquiring Agency shall accept Phase Improvements that are constructed within Port or City property outside of the Phase boundary, subject to a demonstration of how the subsequent Phase Infrastructure can be sequenced to avoid impacting the Phase Improvements. Phase Improvements outside of the Phase boundary shall be accepted through an easement or Memorandum of Understanding (MOU) in Port property, which would terminate at the time of recording of the Final Map for the future Phase that will place said facilities into public right-of-ways.

The conceptual limits of the existing Infrastructure to be demolished as well as conceptual layouts of the permanent and/or temporary infrastructure systems for each Development Parcel will be provided as part of the construction document submittals for that Development Parcel or Phase. Repairs and/or replacement of the existing facilities necessary to serve the Development Parcel will be designed and constructed by the Developer.

Where requested by Developer, and if the Acquiring Agency(s) with jurisdiction over the affected Infrastructure, determines it is appropriate in connection with the phased development of the Project, portions of the Phase Improvements may be constructed or installed as interim improvements to be owned and maintained by the Developer. Interim improvements would be removed or abandoned, as

determined by the Acquiring Agency, when substitute permanent Phase Improvements are provided to serve a subsequent Development Parcel.

Demolition of existing Project area infrastructure and construction of each proposed Development Parcel and associated Phase Improvements will impact site accessibility. During construction of each Development Parcel and associated Phase Improvements, interim access shall be provided and maintained for emergency vehicles, subject to San Francisco Fire Department (SFFD) approval, as well as pedestrian access on at least one side of the street around the construction perimeter that is American with Disabilities Act (ADA) compliant. Interim access to the existing parking will also be maintained and coordinated between the Port, Developer and City, as required.

The Acquiring Agency will be responsible for maintenance of proposed publicly owned and/or accepted Infrastructure installed by the Developer once construction of the proposed Infrastructure is complete and accepted by the Acquiring Agency, except as otherwise specified in the DA, DDA, and/or ICA. At all phases of development prior to full build out, the Developer shall demonstrate to the Acquiring Agency that functioning utility systems are in place at all times and comply with applicable City laws, codes and regulations.

DRAWING NAME: \\ukf-sf\vol14\2008\0600006_Mission Rock\ENG\Exhibits\Infrastructure Plan Exhibit\Plotted Sheets\Figure 1.1 Existing Conditions.dwg
PLOT DATE: 07-13-17
PLOTTED BY: FELI

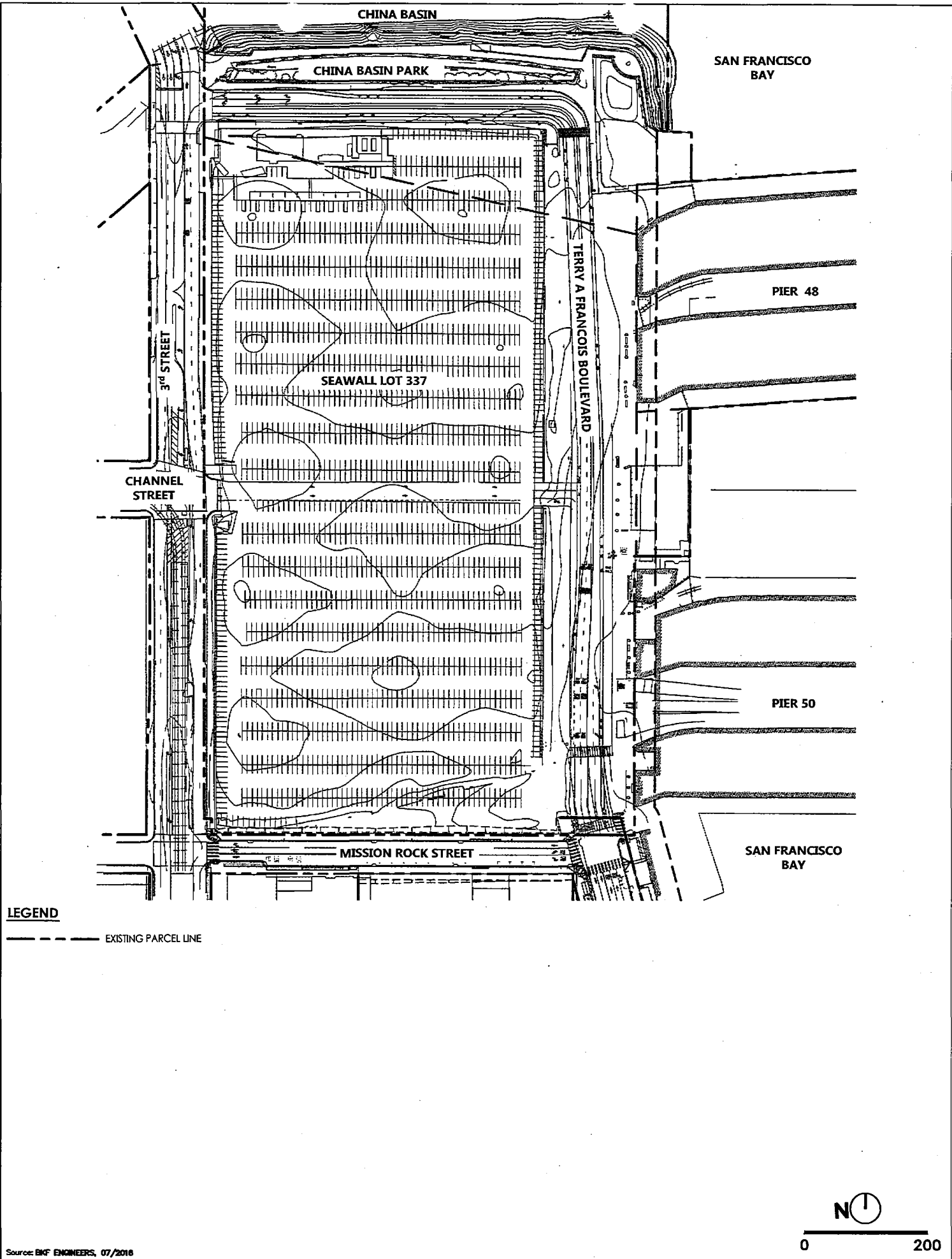

Source: BKF ENGINEERS, 07/2016

DRAWING NAME: \\BKF-SF\vol1\2008\060006_Mission Rock\ENR\Exhibits\Infrastructure Plan Exhibits\Plotted Sheets\Figure 1.2 Conceptual Parcelization.dwg
PLOT DATE: 07-13-17
PLOTTED BY: FEL

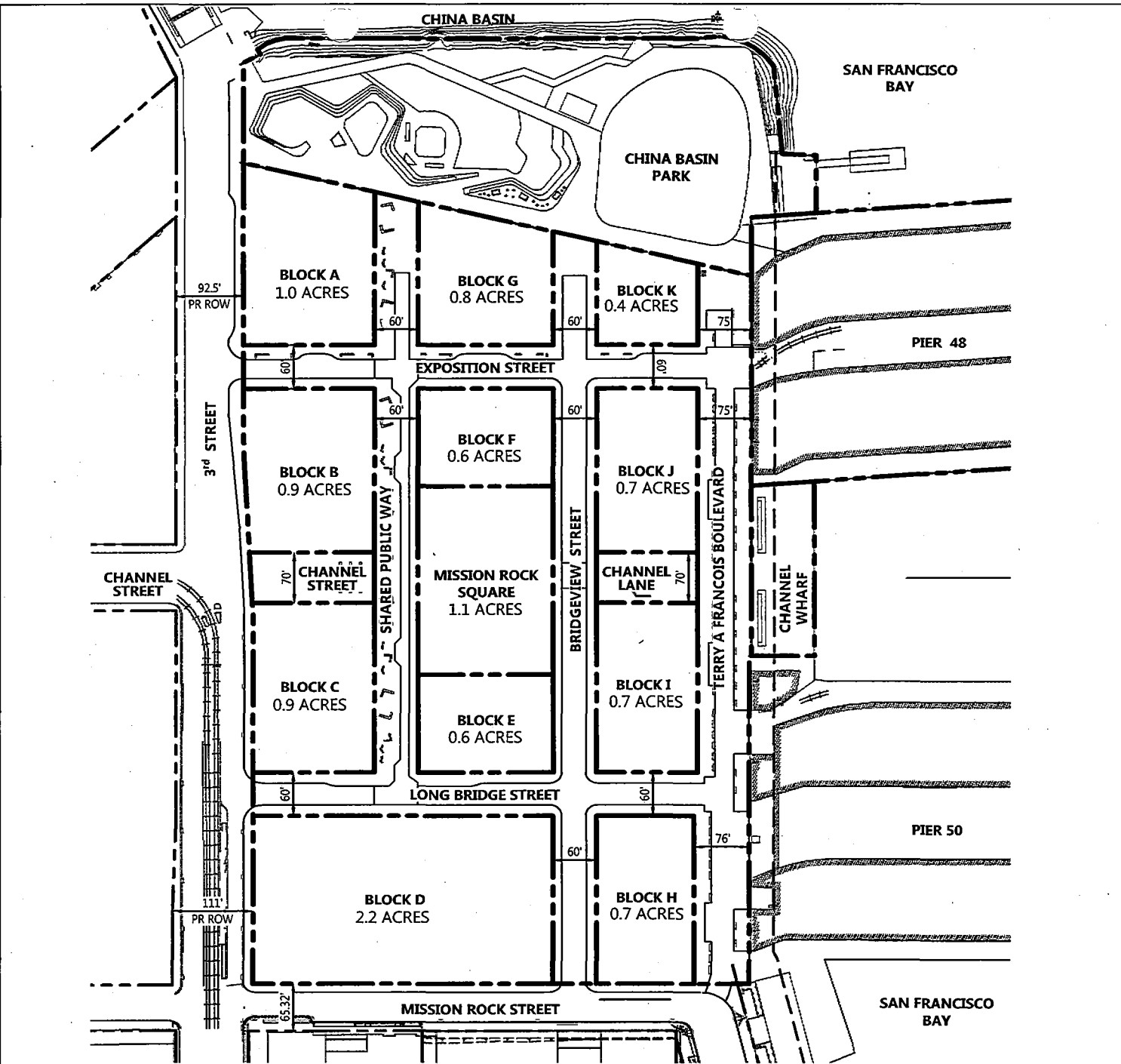

LEGEND
- - - - - PROPOSED PARCEL LINE
- - - - - EXISTING PARCEL LINE

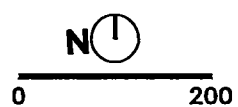

2. SUSTAINABILITY

The Mission Rock Project will be a leading exemplar for sustainable design development through high performance infrastructure and attention to community health and prosperity. Improvements comply with the City and County of San Francisco and State sustainability requirements including Title 24 (Divisions 6 and 11), San Francisco Non-Potable Water Ordinance and The San Francisco Green Building Code. Key benefits of the Project's sustainable site design and infrastructure elements include improved health, a cleaner environment, minimal water dependency, and greenhouse gas-free energy. Anticipated sustainable infrastructure includes, but is not limited to, stormwater management facilities (i.e. landscaped park areas, landscape strips, flow-thru planters, bioretention areas), a central energy distribution plant and infrastructure, treatment of greywater for non-potable reuse within the buildings, green building material selection, and water fixture and lighting efficiency. A more detailed description of the sustainability strategies for the Project is found in the latest edition of the Sustainability Strategy Document, attached to the DDA.

3. ENVIRONMENTAL REMEDIATION

3.1 Historical Use Background

The Project is proposed to be located in an area that was formerly an industrial property built upon filled marshland and shallow tidal flats between 1877 and 1913. The existing fill includes construction and demolition debris, rubble, rock and dirt originating from the nearby hills and the 1906 earthquake. The site has been historically used for railroad transportation, shipping related support structures and automobile parking. H&H Ship Service occupied the area from 1950 to 1996 for wastewater treatment and transfer operations to treat petroleum contaminated wastewater. In 1978 the Department of Health Services, now known as the Department of Toxic Substances Control (DTSC), declared wastes managed at the Project site to be hazardous under federal and state hazardous waste management regulations and the property was later designated as a hazardous waste treatment facility. The DTSC approved a Closure Plan prepared by H&H Ship Service which was compliant with the California Hazardous Waste Control Law (HWCL) in 1995. As a requirement to the hazardous waste treatment facility closure, use restrictions are imposed on the Project site and compliance with a Soil Management Plan (SMP) prepared by Geomatrix Consultants in 1999 is required (see Appendix C).

3.2 Environmental Constraints and Regulations

The Project site is subject to environmental monitoring regulations and use restrictions that will impact the Project Improvements. The Developer is responsible for addressing and complying with the following regulations and restrictions for the site:

3.2.1 Maher Ordinance Requirements and Site Assessment

The Mission Rock Project site is within a location required to adhere to Article 22A of the City and County of San Francisco Health Code. This code requirement, often referred to as the Maher Ordinance in reference to the original legislation that resulted in regulation, requires project proponents to evaluate the presence of contaminants in soil and groundwater and, if warranted based on presence of contaminants, develop health and safety plans and/or site managements plans to protect workers, future users, and the environment.

The Maher Ordinance site assessment requirements were satisfied during the previous parking lot construction with the development of an SMP, dated June 1999. The SMP provided a summary of the soil samples taken and the contaminants detected throughout the site. The primary chemicals

detected in the soil included polynuclear aromatic hydrocarbons (PAHs) and metals such as antimony, arsenic, copper, lead, nickel and mercury. The groundwater sampling did not yield PAH contaminants, but did show low concentrations of several metals. It was determined that the presence of chemicals within the soil and groundwater are not considered an unacceptable risk to future on-site construction workers, nearby residents and visitors under the future use as a paved parking lot that was anticipated at that time. However, to best manage the contaminated soil and groundwater, the SMP outlined removal, handling, stockpiling and disposal procedure requirements for the parking improvements, as well as future site development.

3.2.2 Use Restrictions

As part of the regulatory closure of the former H&H Ship Service facility, Covenant to Restrict Use of Property agreements ("use restrictions") were recorded between The Port of San Francisco and the DTSC restricting the use of certain portions of the Seawall Lot 337 property (approximately three acres of total 16-acre site). The use restrictions require that future activities comply with the Maher Ordinance, as applicable, and that the property shall not be used for any of the purposes stated in the use restrictions dated January 27, 2000 and July 25, 2002 (see Appendices D and E). Should the site be developed for any use of that which is listed as "restricted", then a variance request can be submitted to the DTSC for review.

3.3 Anticipated Site Remediation Procedures

The Developer will be responsible for adhering to the requirements stated in this section and will coordinate with the appropriate Agency for environmental clearance prior to construction, as required. The Project requirements are described in the Hazardous Soil Remediation Plan Letter "Mission Rock Development – Seawall 337 San Francisco, CA 1868-00," dated September 12, 2011 by Ash Creek Associates, Inc. (See Appendix B).

3.2.1 Maher Ordinance Compliance

The anticipated site remediation procedures will remain consistent with the SMP. The SMP will also be updated as required to support the Project. These remediation construction procedures shall include, but not be limited to, dust control, erosion and sediment control, stockpile management and appropriate soil disposal and sampling. Any excess soil that has been excavated and cannot be re-used within the excavation area will be considered waste soil and will be profiled.

to determine suitable disposal options. Although chemical analysis results show that the soil samples collected on-site contain metal and organic constituents at concentrations less than the Total Threshold Limit Concentrations, additional testing may be needed to determine the concentration of soluble constituents and appropriately classify waste soil with respect to California state waste classification criteria. Waste soil containing contaminants at concentrations exceeding the Solubility Threshold Limit Concentrations of the State will be profiled as California Hazardous Waste and will be disposed of at the appropriately licensed landfill location.

The SMP requirements are consistent with the current parking lot site improvements. However, due to changes in the regulation, which now requires characterization of soil gas in some cases, and proposed change in use, additional evaluation of site conditions for compliance with the Maher Ordinance may be required. These issues will be discussed with the City and County of San Francisco Department of Public Health during a meeting with the Project team and additional documentation may be required

3.2.2 Use Restriction Variance

The January 27, 2000 use restriction states that residential housing is prohibited. Mission Rock is currently proposing high-density housing improvements on a portion of land subject to that restriction. It is the Project team's understanding that the intent of the use restriction is to prevent residents' direct contact with site soil, such as might occur in single family home development , but would not occur in a high-density, multi-family residential development. Consequently, the Developer and Port of San Francisco will work with the DTSC to revise or obtain a variance from the existing use restriction to enable proposed development in a manner that does not enable future site occupants to come into direct contact with existing site soil.

4. SITE DEMOLITION

4.1 Scope of Demolition

The Developer will be responsible for the demolition and deconstruction of all non-retained existing buildings and infrastructure features. Demolition and deconstruction will include removal and disposal of hardscape, landscape, utilities, and temporary building structures. The demolition limit of work consists of the existing parking lot known as Giants Lot A, China Basin Park, Terry A Francois Boulevard and select sidewalk and vehicular pavement replacement along 3rd Street and Mission Rock Street. The existing Channel Wharf at the eastern end of Terry A Francois Boulevard will be renovated and Pier 48 will remain and undergo structural upgrades with the Project improvements. Demolition activities will be performed in compliance with the City Construction Demolition Debris Ordinance. Project demolition and grading activities will comply with City Ordinance 175-91 for use of non-potable water for soil compaction and dust control. Where feasible, concrete and asphalt pavements will be recycled and used on-site or made available for use elsewhere. Soil removal associated with demolition activities will comply with the Project environmental permit requirements.

As part of the vegetation grubbing and clearing operation, trees and other plant materials will be removed, relocated or protected in placed, as required. Tree removal within the public right-of-way will be reviewed and approved by the Department of Public Works, Bureau of Urban Forestry. Trees and plant materials removed as part of the demolition process will be recycled by composting or similar methods for on-site uses associated with the planting of new vegetation and erosion control to the extent feasible.

The Developer shall be responsible for providing for the Infrastructure permanent improvements proposed to replace the existing infrastructure in accordance with approved building and construction permits issued by the Acquiring Agency. The extent of these improvements and associated demolition will be finalized during the construction document approval process.

4.2 Existing Utility Demolition

Existing utility demolition scope includes storm drain, sanitary sewer, low pressure water and dry utility infrastructure removal. All storm drain utilities and utilities associated with the interim development, The Yard, at the northern edge of the existing parking lot and Terry A Francois Boulevard will be removed and disposed of. A portion of the existing sanitary sewer pipe along Terry A Francois Boulevard will be removed as well and replaced with a sanitary sewer line which will connect the existing Pier 48 and Pier

50 laterals to the public system. Existing water infrastructure along Terry A Francois Boulevard and China Basin Park will also be removed, disposed of and replaced to accommodate the proposed improvements. Gas utilities throughout Terry A Francois Boulevard will be removed and existing laterals that serve Piers 48 and 50 will be protected in place. Electric, telecom and fiber infrastructure will be undergrounded with new connections to Pier 48 and Pier 50 provided, where required. Existing outfalls on Terry A Francois and China Basin Park will be protected in place during adjacent demolition activities. Where transite pipe (asbestos-cement pipe) is encountered, appropriate abatement methods will be used to satisfy applicable regulatory agency requirements.

4.3 Phases of Demolition

Demolition will occur in phases based on the principle of adjacency and as-needed to facilitate a specific proposed Development Phase and consistent with the requirements of the DA, DDA and ICA. The amount and location of demolition will be the minimum necessary to support the Development Phase and maintain minimum required parking allocations, access and utility connections. Such phased demolition will allow the existing utility services, vehicular and pedestrian access areas, and landscaped spaces to remain in place as long as possible and reduce disruption of existing uses on the site and adjacent facilities. Project demolition activities will comply with City Ordinance 175-91 for use of non-potable water for soil compaction and dust control.

5. SITE RESILIENCY

5.1 Overview

Resilience is the ability to reduce risks and recover more easily from natural occurring events with large impacts on performance and use. The Project is located adjacent to the San Francisco Bay and faces potential risks from such events as earthquakes, settlement, liquefaction, lateral spreading, wave run-up, sea level rise, and climate change. The Developer plans to build site resiliency into the Project by implementing disaster risk reduction and resilient infrastructure. The Project will identify development areas and Infrastructure guidelines to accommodate tidal elevations, the 100-year Base Flood Elevation (BFE), and Sea Level Rise (SLR).

5.2 Project Datum

Elevations, including tidal elevations and site elevations, referred to herein are on the MBD. Refer to Section 1.4 for additional information related to the MBD and conversion information for OCD and SFVD 13.

5.3 Federal Emergency Management Agency Regulations

The Federal Emergency Management Agency (FEMA) under the jurisdiction of the Department of Homeland Security has recently completed a Preliminary City and County of San Francisco Flood Insurance Study (SF FIS) Number 060298V00A, version 2.3.2.0, dated November 12, 2015. This study has helped inform the development of preliminary Flood Insurance Rate Maps (FIRM) that categorize sites within "Flood Zones" based on their susceptibility to flood events. Flood Zone designations are used to inform the design process and insurance requirements for buildings to ensure that protections are made for human health and safety based on the flood hazard potential at a particular site. Per the FEMA website, the following is a description of the various Flood Zone designations employed by FEMA:

"Flood hazard areas identified on the Flood Insurance Rate Map are identified as a Special Flood Hazard Area (SFHA). SFHA are defined as the area that will be inundated by the flood event having a 1-percent chance of being equaled or exceeded in any given year. The 1-percent annual chance flood is also referred to as the base flood or 100-year flood. SFHAs are labeled as Zone A, Zone AO, Zone AH, Zones A1-A30, Zone AE, Zone A99, Zone AR, Zone AR/AE, Zone AR/AO, Zone AR/A1-A30, Zone AR/A, Zone V, Zone VE, and Zones V1-V30. Moderate flood hazard areas, labeled Zone B or Zone X (shaded) are also shown on the FIRM, and are the areas between the

limits of the base flood and the 0.2-percent-annual-chance (or 500-year) flood. The areas of minimal flood hazard, which are the areas outside the SFHA and higher than the elevation of the 0.2-percent-annual-chance flood, are labeled Zone C or Zone X (unshaded)."

5.3.1 Seawall 337, China Basin Park and Terry A Francois Boulevard FEMA Flood Plain Designations

Based on our review of the Preliminary Flood Insurance Rate Map 0602980119A (Project FIRM), dated November 12, 2015, the Mission Rock development site, excluding Pier 48, Pier 50, and the coastal perimeter along China Basin Park, is located in a flood hazard classification of "Zone X."

Per the Project FIRM, the Zone X designation of our site describes the following:

"0.2% Annual Chance of Flood Hazard, Areas of 1% annual chance flood with average depth less than one foot or with drainage areas less than one square mile."

With a Zone X designation, the Project site is subject to minor flooding of less than a foot during large storm events, which is considered a low to moderate risk area.

Since the majority of the site is in Flood Zone X, FEMA does not require specific grading or flood-proofing requirements. Proposed site grading, described in greater detail in Section 7, will be designed to elevate the site higher than the existing condition to protect against the effects of SLR, which in turn will provide a greater level of protection against the potential for flooding the area. Proposed buildings with basements and loading docks will comply with FEMA regulations and provide appropriate flood-proofing measures to ensure compliance, if required.

5.3.2 Pier 48, Pier 50, and Coastal Perimeter FEMA Flood Plain Designation

Based on the Project FIRM, Pier 48, Pier 50, and the coastal perimeter along China Basin Park are located in a SFHA "Zone AE," which has a 100-year base flood elevation (BFE) of 11-feet (NAVD 88 datum). The more detailed Preliminary SF FIS, dated November 12, 2015 indicates a 1-percent annual chance Total Water Level Elevation (TWLE) of 11.4-feet (NAVD 88), which is the assumed 100-year BFE value for the pier structure for the purposes of this analysis. The TWLE is the maximum combined sea water level elevation, wave setup, and wave run-up considered for coastal BFEs.

The datum conversion is approximately 11.32-feet between NAVD 88 and OCD, and 100 feet between the OCD and MBD. Combining these datum conversions, the approximate conversion

from elevation 11.4 feet (NAVD 88) to the MBD is 88.68 feet, resulting in a 100-year BFE of 100.08 feet (MBD) for Pier 48, Pier 50, and the coastal perimeter along China Basin Park.

Based on the Project FIRM, the existing pier structures are subject to flooding from the 1% annual flood event (100-year event). The BFE refers to the minimum elevation at which Pier 48 and Pier 50 must be elevated or flood-proofed in compliance with FEMA/National Flood Insurance Program (NFIP) regulations to provide protection from the 1% annual flood event. Given a designation of SFHA "Zone AE" with a BFE of 11.4 feet (NAVD 88) / 100.08 feet (MBD), the Pier 48 and Pier 50 structures would be subject to mandatory Flood Insurance coverage requirements from the NFIP should the preliminary Project FIRM be officially approved. Since the Pier 48 and Pier 50 structures are a historical resource and will remain at its current elevation, there may be options for receiving variances for portions of Flood Insurance requirements that the structure may be subject to.

5.4 Sea Level Rise

5.4.1 Sea Level Rise Design Guidance

The increase in elevation of the Earth's water bodies over time is referred to as SLR. As SLR occurs, there is increased pressure on infrastructure along shoreline areas to provide protections for infrastructure, health, and safety. Studies on the effects of climate change on surface water elevations across the Earth are evolving as more scientific data becomes available. The following is a brief chronology of the guidance documents that inform the SLR strategies being developed for the Project to date:

- The Intergovernmental Panel on Climate Change (IPCC) was formed in 1988 by the World Meteorological Organization (WMO) and the United Nations Environment Programme (UNEP) to provide policy makers with regular assessments of climate changes on a scientific basis. The IPCC issues reports which are produced by three working groups. The latest round of documents issued are based on their fifth assessment report which includes the following:

- Working Group 1, "Climate Change 2013: The Physical Science Basis," dated 2013.
- Working Group 2, "Climate Change 2014: Impacts, Adaptation, and Vulnerability, dated 2014.
- Working Group 3, "Climate Change 2014: Mitigation of Climate Change," dated 2014.
- IPCC, "Climate Change 2014: Synthesis Report," dated 2014.
- Governor Schwarzenegger issued Executive Order S-13-08 in 2008 directing state agencies to study and plan for the potential effects of SLR
- Port Engineering commissioned URS and AGS to analyze available literature and studies related to SLR and prepare coasting engineering analysis of the Port's Northern Waterfront. The joint venture between URS and AGS published "Port of San Francisco Sea Level Rise and Adaptation Study," January 2012.
- The National Research Council (NRC) issued the report titled "Sea Level Rise for the Coasts of California, Oregon, and Washington," dated June 2012 and revisions dated December 6, 2013.
- Coastal and Ocean Working Group of the California Climate Action Team (CO-CAT) with science support from the Ocean Protection Council's Science Advisory Team and the California Ocean Science Trust issued "State of California Sea-Level Rise Document," dated March 2013
- City and County of San Francisco (CCSF) Sea-Level Rise Committee "Guidance for Incorporating Sea-Level Rise into Capital Planning in San Francisco: Assessing Vulnerability and Risk to Support Adaptation," September 2014.
- City and County of San Francisco (CCSF) "San Francisco Sea Level Rise Action Plan," March 2016.
- San Francisco Bay Conservation & Development Commission (BCDC) and Delta Alliance issued "Mission Creek Draft Sea Level Rise Adaptation Study," dated 2015.

5.4.2 Sea Level Rise Design Parameters

The minimum design elevations for the Project development area will accommodate potential future sea level rise estimates for San Francisco Bay. The SLR estimates for the Project were developed in response to the CCSF SLR guidance, which is based on both the NRC and CO-CAT

studies. Under CCSF SLR guidance, the Project will be designed to accommodate the SLR criteria provided in Table 5.1.

Table 5.1

SLR and Associated Planning Requirements for Development Area

YEAR	SLR AND PLANNING REQUIREMENTS
2030 SLR	6 to 12-inches by 2030. Planning for adaptive management not required.
2050 SLR	11 to 24-inches by 2050. 12-inches is the mean 2050 estimate for SLR. Planning for adaptive management not required.
2065 Mean SLR	16-inches by 2065.
2100 Mean SLR	36-inches by 2100. Planning for adaptive management required.
2100 High SLR	66-inches by 2100. Planning for adaptive management required.

The existing historical Pier 48 structure and Channel Wharf will remain at their current elevations and not incorporate provisions included in Table 5.1.

5.4.3 Existing Mission Bay Grading for Resiliency

The existing finished grades in Mission Bay adjacent to the Project site range from elevations 97-100.5 feet (MBD). Grading and hydrology designs for Mission Bay were established prior to the more recent SLR investigations of the past 8 years, and do not accommodate for the 2100 High SLR estimates as currently graded. The existing perimeter streets of the Project including 3rd Street and Mission Rock Street will remain at their approximate existing grades. Along the east edge of the Project, Terry A Francois Boulevard will be reconstructed relatively close to its current grade. For existing grades at the Project site and surrounding existing streets, refer to Figure 7.1.

5.5 Proposed Site and Infrastructure Designs

5.5.1 Grading

The proposed Project grading designs and approaches are documented in Section 7 Site Grading. The grading design criteria have been separated between:

- Elevation design criteria as it relates to tides, SLR, site elevations, HGL and existing streets
- Grading design criteria as it relates to site slopes.

The following summarizes the grading approaches for site building parcels and roadway areas,

open space areas, and historic structures:

- Maintain public access along the entire 100-foot shoreline band.
- In the zone between the development area and shoreline, provide access opportunities to water.
- Elevate and flood-proof proposed buildings and unadjustable structures to minimize the need for adaptive measures, even under high SLR estimates.
- Conform to grades of existing perimeter streets, pier structures, and wharf structure.

5.5.1.1 Building and Roadway Areas

The minimum elevation design criteria for the proposed buildings and streets within the development areas are shown in Table 5.2.

**Table 5.2
Elevation Design Criteria**

AREA	MINIMUM DESIGN CRITERIA
Development Area – Proposed Buildings	Provide a minimum finished floor elevation of 104.0 feet (~95 feet 2000 Mean Higher High Water elevation (MHHW) + 100-yr storm surge (100SS) (~3.5 feet) + 66 inches of 2100 High SLR) and/or flood-proof to 2100 High SLR projections for new occupied facilities.
Development Area – Proposed Parking Structures	The Block D Parking Garage entrances will be set based on the grade of the adjacent street. At a minimum, the garage entrances will be set with a minimum finish floor elevation of 99.83 feet (95 feet 2000 MHHW + 100-yr storm surge + 16 inches of 2065 Mean SLR). As required, Adaptive Management Strategies will be incorporated within the structure to provide resiliency and protection through 2100.
Development Area – Proposed On-Site Streets	<p>The street elevation shall accommodate 4 feet in general and 2 feet minimum freeboard between the 5-year storm drain system HGL and the street gutter flow line.</p> <p>For streets with City standard 4-inch to 8-inch tall curbs, the street’s lowest top of curb elevation shall be above the HGL for the 100-year storm for the storm drain system. Refer to Section 13.</p> <p>For curbless streets or streets with flush curbs, hydraulic modeling and overland release</p>

	requirements will be determined during the approval process for the MUPs.
Development Area – Pier 48	The pier structure will remain at existing elevation. As SLR occurs, Adaptive Management Strategies may be incorporated within the structure to provide resiliency and protection through 2100, subject to jurisdictional approval.

For adjacent streets serving the project, including 3rd Street and Mission Rock Street, street elevations will remain relatively close to their current elevations. Along the east edge of the project, Terry A Francois Boulevard will be reconstructed relatively close to its current elevation. Proposed streets within the development will slope up from the existing conform elevations of approximate elevations of 99-101.5 feet at 3rd Street, Terry A Francois Boulevard, Piers 48 and 50, and Mission Rock Street to elevations of approximately 102.9-104.3 feet at the center of the site. By elevating the center of the site, access can be provided to building finished floors, which are set to accommodate protection from the 2100 High SLR projections or be flood-proofed to meet the 2100 High SLR projections.

5.5.1.2 Shoreline Open Space Areas and Parks

5.5.1.2.1 China Basin Park

China Basin Park will maintain shoreline elevations close to the existing grade of approximately 100 feet (MBD). The park will transition to the Bay Trail at an approximate elevation of 102 feet (MBD) through the center of the park. The Bay Trail through the center of the park provides approximately 6 feet of freeboard from the King Tide elevation of 96 feet (MBD). When the sea level rises above 48-inches, the park will function as a space where future adaptations will creatively be implemented to maintain flood protection for existing public access features. The promenade, which interfaces between the south portion of the park and the northern part of the development area, will maintain access to the public at an elevation of approximately 103.5 – 104 feet (MBD).

5.5.1.2.2 Historical Pier Structures

Pier 48 and Pier 50 are historical structures that will be maintained at existing elevations. The existing grades for accessible areas at Pier 48 range from 99.2 to

101.0 feet (MBD). Accessible areas at Pier 50 have existing grades of 99.5 to 100.9 feet (MBD). The low lying areas of the piers may be susceptible to the 100-year TWLE of 100.08. Since the existing pier structures are historic resources, they will remain in place. To minimize impacts during a 100-year storm event, the interfacing street of Terry A Francois Boulevard will be regraded to channel stormwater away from the pier structures. Existing grades of the piers provide protection beyond 2050 Mean SLR for potential future flooding.

5.5.2 Stormwater System

The 100-year Still Water Level Elevation (SWLE) is the 100-year return period water elevation, which is defined as the water elevation that is exceeded on average once every 100 years or the water elevation with a 1% annual chance of occurrence.

The SWLE for the design of the Development Area is 98.5 feet (MBD). The 100-year return period water elevation for the Development Area includes the effects of tides, storm surges, and tsunamis. The SWLE has been included with the drainage design of the 100-year storm event and overland flow release.

With the project's proximity to the San Francisco Bay, the Project must consider tidal elevations for drainage outfall conditions. The tidal elevation within the San Francisco Bay Area varies by location. The 2015 Subdivision Regulations identify a tidal elevation of 96.5 feet (MBD, -3.5 feet Old City Datum) for hydraulic grade calculations.

The SLR and tidal elevations for the Project have been prepared in the SLR Adaptation Strategy Memorandum by Moffatt & Nichol in Appendix I. The tidal elevations, SWLE, and SLR for the Project have been compiled in Table 5.3.

Table 5.3

Tidal Elevations, SWLE and SLR by Datum

Elevation	NAVD88	OCD	MBD
100-Year SWLE+66" SLR (2100 High SLR) (MHHW+100SS+66" SLR (2100 High SLR))	15.3'	4.0'	104.0
100-Year SWLE+36" SLR (2100 Mean SLR) (MHHW+100SS+36" SLR (2100 Mean SLR))	12.8'	1.5'	101.5
100-Year SWLE+16" SLR (2065 Mean SLR) (MHHW+100SS+16" SLR (2065 Mean SLR))	11.1'	-0.2'	99.8'
100-Year SWLE+12" SLR (2050 Mean SLR) (MHHW+100SS+12" SLR (2050 Mean SLR))	10.8'	0.7'	99.5'
100-Year SWLE	9.8'	-1.5'	98.5'
Subdivision Regulations Tidal Elevation	7.8'	-3.5'	96.5'
King Tide (Moffatt & Nichol)	7.3'	-4.0'	96.0'
MHHW	6.3'	-5.0'	95.0'
Mean Sea Level	0.0'	-11.3'	88.7'

5.6 Adaptive Managements Strategies

Sea Level Rise (SLR) has the potential to increase flooding risk along the shoreline areas as the MHHW, 100-year SWLE, TWLE, and BFE increases over time. The Project will be built to protect against varying amounts of SLR and has allocated space for future Adaptive Management Strategies to be implemented in the future to respond to adjusted SLR projections. Strategies for the Project have been developed for development areas, the shoreline, and pier structures.

5.6.1 Development Parcel Strategy

The proposed strategy for the Development Parcels, including unadjustable structures, is to set proposed grades to a minimum of 104 feet (MBD), high enough to accommodate for the current 2100 High SLR projects, thus Adaptive Management Strategies are not required. The Parcel D Parking Garage entrances will be set based on the grade of the adjacent street to accommodate for 2065 Mean SLR of 16-inches.

5.6.2 Shoreline Adaptation Strategy

The shoreline adaptation strategy will be applicable to areas surrounding the Development Parcels. The Promenade and Bay Trail within China Basin Park will be raised to an elevation of 102 feet (MBD) to provide 3.5-feet of freeboard above present day BFE. The China Basin Park shoreline, Terry A Francois Boulevard, 3rd Street, and Mission Rock Street will be maintained at existing grades to provide protection to Development Parcels from inundation during the king tide events beyond 2080. Along the shoreline of China Basin Park, the entire 100-foot shoreline band will be reserved for public access. For SLR above 48 inches, the shoreline band will provide an opportunity for creative implementation of future adaptation strategies to maintain flood protection to Mission Bay and the Development Parcels. Adaptive Management Strategies within China Basin Park may include modifications to create a raised promenade with retaining walls, realignment of the promenade, reconfiguration of shoreline protection to provide flatter slopes and wave breaks. Beyond 2050, future Adaptive Management Strategies may be implemented by the Port to the pier apron and below the pier structure to maintain flood protection for the structure.

Today, the National Oceanic and Atmospheric Administration (NOAA) monitors weather conditions and notifies the public of potential risk for flooding in low lying areas. Future adaptation of the shoreline would be enacted by the Port when published information from NOAA indicates that flooding to the public access areas would occur during King Tide events. Funding for Adaptive Management Strategies would be provided by the Port through a Community Financing District (CFD) or other equivalent funding mechanism.

6. GEOTECHNICAL CONDITIONS

Site geotechnical investigations have been completed and potential site wide geotechnical improvements have been identified by Langan Treadwell & Rollo, culminating in the development of the "Preliminary Geotechnical Investigation Seawall Lot 337 – Mission Bay" (Geotechnical Report) by Treadwell & Rollo, dated September 8, 2011 and subsequent evaluations. In addition, Langan Treadwell & Rollo has also provided a supplemental memorandum: "Preliminary Geotechnical Recommendations and Summary Memorandum No. 1" (Geotechnical Memorandum), dated January 26, 2016 for additional reference, which is attached as Appendix F.

6.1 Existing Site Geotechnical Conditions

The site was originally a shallow bay below water and a part of Mission Bay. It is understood the site was elevated using building rubble and debris from the 1906 San Francisco earthquake as fill. Borings indicate 13 to 37-feet of heterogeneous fill is underlain by approximately 46 to 72-feet of Bay Mud consisting of weak, soft to medium stiff, compressible clay. The over-consolidated Bay Mud at the site is evidence of complete settlement under the existing fill weight. Locations where Bay Mud has failed beneath the heavy fill loads show a "Bay Mud wave" condition and is comprised of clayey gravel and gravely clay. The borings also encountered the bedrock surface to be at a depth of approximately 160-feet near the northwest corner of the site and 260-feet near the northeast corner of the site.

Groundwater was encountered approximately 7 to 9-feet below grade (Elevations 91 to 93 feet MBD). Other sites within Mission Bay have encountered groundwater measured at approximately five feet below grade (Elevation 94.5 feet MBD).

6.2 Existing Site Geotechnical Constraints

6.2.1 Liquefaction/ Settlement of Sand Layers

Liquefaction is the transformation of soil from a solid state to a liquefied state during an earthquake where saturated soil builds up excessive pore water pressure and temporarily loses its strength. The result is immediate settlement and possible lateral movement of the sand material. Conservatively, all loose to medium dense soil materials (sands, silts and low plasticity clays) within both the artificial fills and underlying Bay Deposits are potentially liquefiable. The potential for soil liquefaction is likely to occur during a major earthquake. With the potentially liquefiable layers being random and discontinuous throughout the site, it is estimated the site will experience up to 3-inches of liquefaction-induced settlement within the fill material of the site. Along the west

end of Pier 48, the analysis indicated that 3 to 5-inches of liquefaction-induced settlement could occur.

6.2.2 Lateral Spreading

Lateral spreading is considered the most damaging type of liquefaction-induced ground failure caused by earthquakes. In this case, surficial soil is displaced along a shear zone that has formed within a liquefied layer resulting in surficial blocks sliding downward toward unbound space, such as the Bay. These conditions are common in multiple San Francisco regions, such as the Downtown and Mission Bay districts. The southeast corner and northwest portion of the Project have been identified as being susceptible to lateral spreading estimated to result in 4 to 6-feet of lateral displacement during a large earthquake.

6.2.3 Settlement of Bay Mud

The site is underlain by a layer of Bay Mud estimated to be 46 to 72-feet thick, which appears to be over-consolidated. Placing the new fill on top of the existing bay mud layer will initiate a new cycle of consolidation settlements for the Bay Mud layer. It can be expected that for each additional foot of fill placed on the site, approximately 2-inches of settlement may occur at entrances to pile supported structures, 3-inches within streets, and 4-inches in open space areas. During an earthquake, an additional settlement of approximately 9 inches could potentially occur due to seismic densification and liquefaction. For proposed building and structures designed to be pile supported, it is anticipated that 1 to 2-inches of settlement may result from a major earthquake.

If mitigation measures or preventative designs are not incorporated, differential settlement may occur and result in interrupted access, utility infrastructure damage, and accessibility issues.

6.3 Geotechnical Approaches

Successful site development will require engineering design and project construction methods that account for the existing soil, existing conforms, and shoreline conditions. These improvements will help ensure that site accessibility and building access is maintained during seismic events, SLR, and minor long-term consolidation settlement. Proposed building will be constructed on piles with a similar approach proposed for the on-site streets and utilities supporting the new development. The

geotechnical design approaches considered and recommended for the Project have been summarized below and are documented in the Geotechnical Memorandum.

6.3.1 Site Grading Strategies

The proposed development will be elevated 1 to 5-feet above existing grade to accommodate for future SLR. The use of soil fill to raise the site would cause ground settlement of up to a few feet. At the existing Project conforms with Terry A Francois Boulevard and Piers 48 and 50 to the east, new constructed Mission Rock Street to the south, and existing 3rd Street to the west, proposed grades will match the approximate existing grades to mitigate the potential for settlement. To raise the center of the site, the design team has explored several different alternatives to adding soil fill to the site, which include the following strategies:

6.3.1.1 Soil Surcharging with Wick Drains

Adding mounds of surcharge soil with perforated wick drains to collect water across the site will induce Bay Mud Settlement in advance of Project construction. This effectively mitigates the settlement of Bay Mud that the new fill proposed as part of the finished Project would typically cause. Considering that parking operations must be maintained at the site prior and during build-out of the Project, this settlement mitigation solution is not appropriate for the Project, since parking availability would be eliminated or severely limited.

6.3.1.2 Deep Soil Mixing

Deep Soil Mixing (DSM) acts to improvement the stability of the underlying site by mechanically mixing cementitious binder slurry with weak and compressible soils. Due to the depth of the Bay Mud layers at the site extending down to nearly 90-feet below existing finished grade, DSM is both cost prohibitive and less practical than other solutions considered by the Geotechnical Memorandum.

6.3.1.3 Lightweight Fill to Raise Grades

Lightweight fill materials such as cellular concrete or Geofam weigh less than traditional soil fill. Using such materials in lieu of soil to raise site grades significantly reduces the settlement of the Bay Mud layer. However, lightweight fill may present several utility installation and maintenance challenges. Installation of utilities can be difficult, as cutting

foam in the shape of the utilities may not be easily feasible. Long term maintenance of utilities within Geofoam would also require cutting of the Geofoam to access the utilities, which is a labor and cost intensive process. Additionally, storm drain and sanitary utilities will be installed as deep as 12 to 13-feet below finished grade, which is within the groundwater table, and can potentially cause uplift and complex dewatering strategies. Although lightweight fill is not anticipated to be used throughout the majority of the site, it may be utilized within park areas where utility grids and access for maintenance and operations is not a constraint.

6.3.1.4 Pile supported structures, streets and utilities

Due to the infeasibility of other options outlined above, the proposed Project streets are proposed to be pile supported "U-shaped" corridors that extend the width of the right-of-way and built to a depth required to support the installation of utilities. The "U-shaped" corridor would then be backfilled with soil to provide the typical street sub-surface condition, allow utilities to be installed with standard trenching method, and provide for long term utility and infrastructure maintenance using typical construction and City standards. Pile designs could include friction or end-bearing solutions with final designs prepared and approved during the construction document process. This is the preferred solution for mitigating site settlement issues, and with site structured street approaches are described in greater detail in Section 8 and on Figure 8.14 of this document. The pile-supported structure for the streets will be owned, maintained and accepted by the Acquiring Agency subject to the terms of the DA, DDA, and ICA.

6.3.2 Liquefaction and Lateral Spreading Mitigations

In order to mitigate the potential effects of earthquake induced lateral spreading and soil liquefaction, the Project proposed to incorporate solutions that would include Stone Columns, Deep Dynamic Compaction, or combination of both solutions.

Compaction Grouting and Rapid Impact Compaction (RIC) were also reviewed as potential solutions for mitigating lateral spreading and liquefaction. However, RIC has proven successful to depths of 10-feet, which is less than required for the site, and there is not enough soil overburden present in the site soils to handle the required pressures for Compaction Grouting.

6.3.3 Flexible Utility Connections

Portions of the site may experience differential settlement at the interface of pile supported streets with proposed buildings and the utility connections at 3rd Street, Mission Rock Street, Terry A Francois Boulevard, and China Basin Park. Differential settlement at these location could cause the utility connections to shear and break along this plane. Therefore, flexible utility connections, incorporating such solutions flexible pipe materials, ball joints or settlement vaults, may be installed at the interface of the structured street with a non-structured on-grade street (Terry A Francois Boulevard, Mission Rock Street, 3rd Street, or China Basin Park) to mitigate the displacement of the utility connections and ensure continuous utility service to the Project and existing adjacent properties. Conceptual locations of flexible utility connections are shown on Figure 6.1 with a conceptual flexible utility section included as Figure 6.2. Final design solutions, will be subject to review and approval by the Acquiring Agency. Ownership of flexible connections will be by the Port, unless the SFPUC agrees to accept flexible connections at a later date prior to project construction document approvals or as indicated in the DA, DDA, ICA, or separate MOU/MOA identifying acceptance, ownership, and maintenance responsibilities.

6.3.4 Site Accessibility

Minor Long-term settlement of the ground plane may occur along the site conforms at Mission Rock Street, 3rd Street, and Terry A Francois Boulevard. Where a pile-supported structure interfaces with the on-grade public streetscape, minor differential settlement may occur where the compressible material beneath the street begins to settle relative to pile supported buildings and proposed on-site streets. To mitigate areas where differential settlement is anticipated, grading and building designs will incorporate measures to ensure that continuous accessible paths of travel are maintained where building access points and private passageways interface with the public right-of-ways. Where required, measures such as flexible pavement sections, hinge slabs, gangways, and other adjustable surfaces, may be designed to mitigate the maximum anticipated long-term differential settlement. Refer to Figure 6.1 for the conceptual locations where flexible pavement connections would be required.

6.4 Phases of Geotechnical Stabilization

Geotechnical stabilization will occur in phases based on the principle of adjacency and as-needed to facilitate a specific proposed Development Phase and consistent with the requirements of the DA, DDA,

and ICA. The amount and location of geotechnical stabilization will be the minimum necessary to support the Development Phase and maintain minimum required parking allocations, access and utility connections. Such phased geotechnical stabilization will allow the existing utility services, vehicular and pedestrian access areas, and landscaped spaces to remain in place as long as possible and reduce disruption of existing uses on the site and adjacent facilities. Additional geotechnical stabilization, such as mitigations for lateral spreading and liquefaction, may be completed above the minimum necessary per phase due to constructability and efficiency considerations. Dewatering, and associated permits, may be required to support the Geotechnical Stabilization and construction process



6.5 Schedule for Additional Geotechnical Studies

Supplemental Geotechnical Studies and Reports will be prepared as required to support the proposed Project public improvements. In addition, Geotechnical Reports for private building parcels will be prepared and submitted to the City as part of the building permit process.

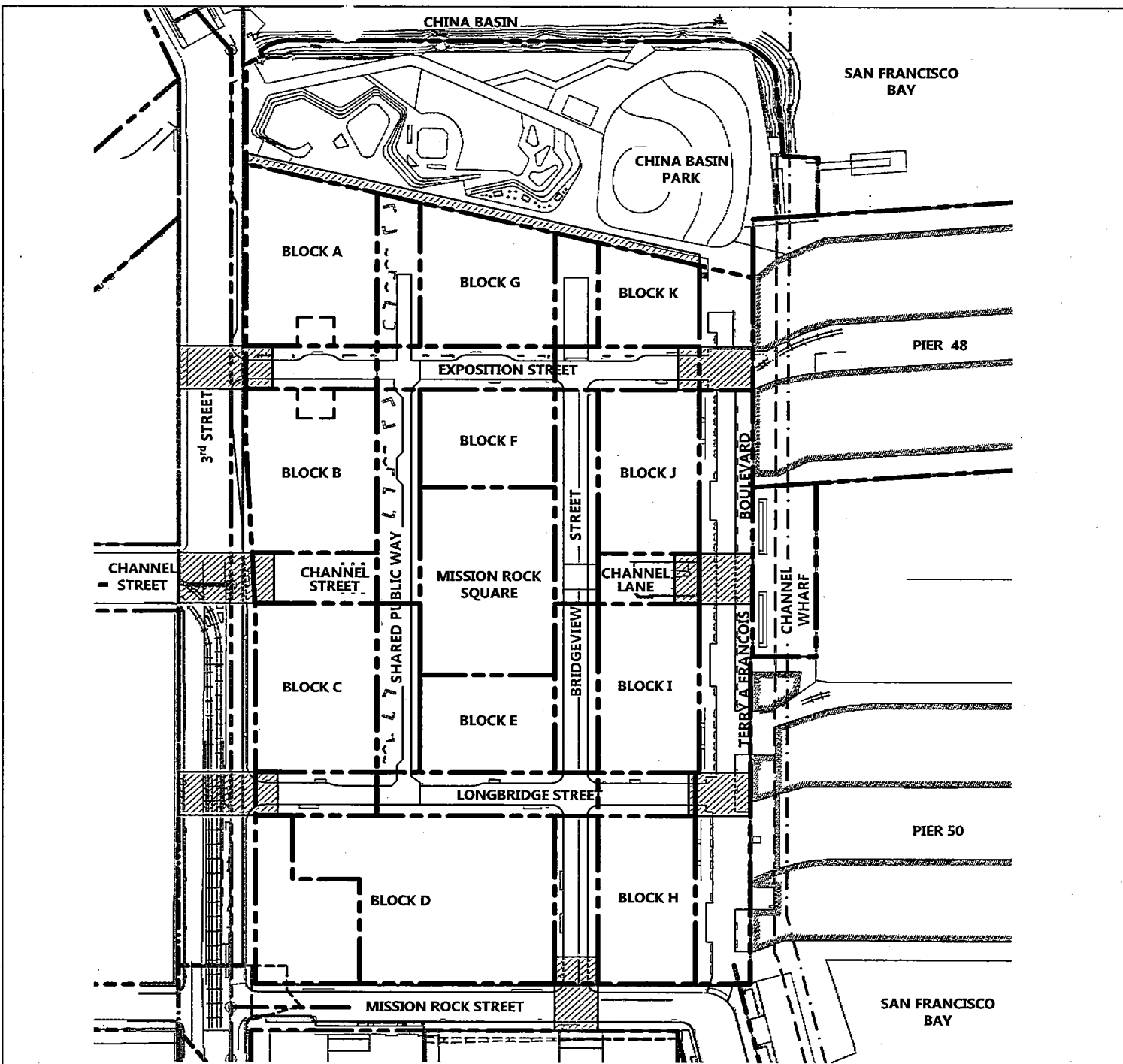
DRAWING NAME: \\BKF-SF\vol14\2008\060000\Mission Rock\Exhibits\Infrastructure Plan Exhibits\Plotted Sheets\Figure 6.1 Flexible Utilities.dwg
 PLOT DATE: 11-15-17
 PLOTTED BY: waik



LEGEND

-  PROPOSED PARCEL LINE
-  EXISTING PARCEL LINE
-  CONCEPTUAL INTERSECTION LOCATIONS WHERE PUBLIC UTILITIES WOULD INCORPORATE FLEXIBLE PAVEMENT AND FLEXIBLE UTILITY CONNECTIONS AT INTERFACE BETWEEN STRUCTURED STREETS AND EXISTING OR PROPOSED STREETS BUILT ON GRADE

Source: BKF ENGINEERS, 07/2016

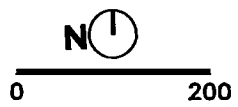

MISSION ROCK INFRASTRUCTURE PLAN **FIGURE 6.1 - CONCEPTUAL LOCATION OF FLEXIBLE PAVING AND UTILITIES**

DRAWING NAME: \\BKF-SF\vol\A\2008\080006_Mission Rock\ENG\Exhibits\Infrastructure Plan Exhibits\Plotted Sheets\Figure 6.2 Flexible Connection Detail.dwg
PLOT DATE: 11-15-17
PLOTTED BY: volk

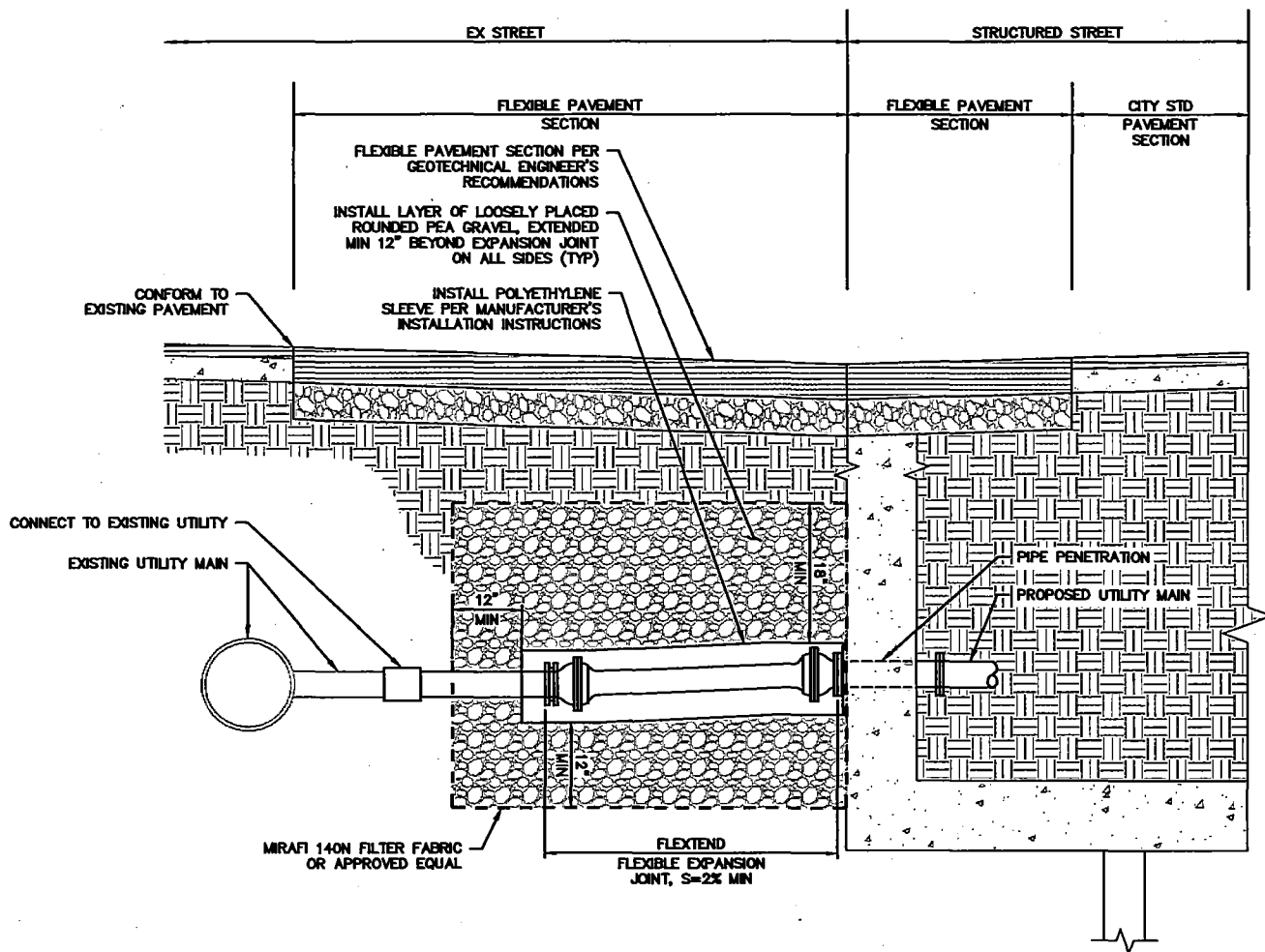

Source: BKF ENGINEERS, 07/2016

7. SITE GRADING

7.1 Project Datum

Elevations, including tidal elevations, HGLs, and site elevations, referred to herein are on the Section 7 MBD, unless identified otherwise.

7.2 Existing Site Conditions

The existing grade within the Project site slopes gradually east, west, and south away from the center of the existing parking lot with ground elevations ranging from approximately 101 feet elevation at high points to approximately 97 feet elevation to the south at low points in the existing parking lot. Along the western and eastern borders, the site is bounded by and conforms to the existing grades along 3rd Street, Pier 48 and Pier 50, with ground elevations ranging from 99 feet to 100.5 feet in elevation. The northern border is bounded by the north interface of China Basin Park at the rip rap of China Basin. Along the southern border, there is a grade different of 3 feet to 4 feet of elevation between the existing parking lot and the newly constructed Mission Rock Street. The existing site elevations are shown in Figure 7.1.

7.3 Site Geotechnical Constraints and Approach

The Geotechnical Report and Geotechnical Memorandum were prepared for the Project by Langan Treadwell & Rollo. The Project site was originally a shallow bay below water as part of Mission Bay. It was later elevated by using building rubble and debris from the 1906 San Francisco earthquake as fill sourced from Potrero Hill. Site investigation found the fill is underlain by Bay Mud, building rubble, and debris.

Placement of new fill on top of existing Bay Mud layers will initiate a new cycle of consolidation settlements. The Project site may experience minor amounts of liquefaction, settlement, and lateral spreading due to existing sand layers and soft Bay Mud. The geotechnical engineer and explored different measures to mitigate these site constraints, which are described in greater detail in Section 6.

7.4 Project Grading Overview

The Developer will be responsible for the design and construction of the proposed grading for the Project. Below is a description of the grading design for the different areas of the site. The proposed Project conceptual grading plan is shown in Figure 7.2.

The Project is comprised of the development area at the center of the project, the Promenade and China Basin Park to the north, and Terry A Francois Boulevard to the east that interfaces with Pier 48, Channel Wharf, and Pier 50. The development area consists of the Development Parcels, open space areas, and structured street grids.

Proposed grading for the Project raises the development area to approximate elevations of 103.5 feet to 104.5 feet at the center of the site. The structured street grid grades will slope down to the existing adjacent streets, the San Francisco Bay and China Basin shoreline, or park and open space areas. The streets and sidewalks have been designed to provide overland release and ADA compliant accessible pathways throughout the site and adjacent parcels. The proposed street grid with interconnected open space and accessible pathways will be constructed to link 3rd Street with Terry A Francois Boulevard in the west-east direction and China Basin Park with Mission Rock Street in the north-south direction. Throughout the site, grades less than 5 percent are provided.

7.5 Elevation and Grading Design Criteria

The grading design criteria has been separated between:

- Elevation design criteria as it relates to tides, SLR, site elevations, HGLs, and existing streets
- Grading design criteria as it relates to site slopes.

7.5.1 Elevation Design Criteria

The minimum elevations are based on the FEMA 100-year BFE. For existing perimeter roads serving the Project and adjacent properties, proposed infrastructure within these existing streets will be designed to accommodate tidal elevations. For more information on the Project as it relates the FEMA, refer to Section 5 Site Resiliency.

7.5.1.1 Sea Level Rise

SLR will result in changing water levels in the San Francisco Bay that the Project will need to accommodate. The design criteria employed at the time of this Infrastructure Plan are based on the best scientific forecasts and potential design strategies currently available. The forecasts will very likely change over time and will provide guidance for the future.

The minimum design elevations for the Project Development Parcels will accommodate potential future SLR estimates for San Francisco Bay as discussed in Section 5 Site

Resiliency. The Project will be designed to accommodate the SLR criteria provided in Table 7.1.

Table 7.1

SLR and Associated Planning Requirements

YEAR	SLR AND PLANNING REQUIREMENTS RELATIVE TO YEAR 2000
2030 SLR	6 to 12-inches by 2030. Planning for adaptive management not required.
2050 SLR	11 to 24-inches by 2050. 12-inches is the mean 2050 estimate for SLR. Planning for adaptive management not required.
2065 Mean SLR	16-inches by 2065. Planning for adaptive management required.
2100 Mean SLR	36-inches by 2100. Planning for adaptive management required.
2100 High SLR	66-inches by 2100. Planning for adaptive management required.

The minimum SLR to be accommodated for the elevation design of structures and streets in the Project is 16-inches. To the extent feasible, the Project plans to develop structures in the Development Parcels to accommodate a 2100 High SLR of 66-inches above the BFE. For more information on the Project as it relates the SLR, refer to Section 5 Site Resiliency and Table 5.1.

7.5.1.2 100-Year Base Flood Elevation and Tidal Elevation

The 100-year BFE is the 100-year return period water elevation, which is defined as the water elevation that is exceeded on average once every 100 years or the water elevation with a 1% annual chance of occurrence.

The BFE for the design of the Development Parcel is 98.5 feet. The 100-year return period water elevation for the Development Parcel includes the effects of tides, storm surges, and tsunamis. The BFE has been included with the drainage design of the 100-year storm event and overland flow release.

With the project's proximity to the San Francisco Bay, the Project must consider tidal elevations for drainage outfall conditions. The tidal elevation within the San Francisco Bay Area varies by location. For Mission Bay, the 2015 Subdivision Regulation identifies a tidal

elevation of 96.5 feet for the Project which has been included in design to analyze the 5-year storm event.

The SLR and tidal elevations for the Project have been prepared in the SLR Adaptation Strategy Memorandum by Moffat & Nichol in Appendix I, and are provided in Table 7.2.

Table 7.2

SLR and Tidal Elevations by Datum

Elevation	NAVD88	Old City Datum	MBD
FEMA 100-Year BFE +66" SLR (100-Year SWLE+66" SLR (2100 High SLR) MHHW+100SS+66" SLR (2100 High SLR))	15.3'	4.0'	104.0
FEMA 100-Year BFE/100-Year SWLE	9.8'	1.5'	98.5'
Subdivision Regulations Tidal Elevation	7.8'	-3.5'	96.5'
King Tide (Moffatt & Nichol)	7.3'	-4.0'	96.0'
MHHW	6.3'	-5.0'	95.0'
Mean Sea Level	0.0'	-11.3'	88.7'

7.5.1.3 Minimum Site Elevations

The minimum elevation design criteria for the Development Parcels are shown in Table 7.3.

Table 7.3

Elevation Design Criteria

AREA	MINIMUM DESIGN CRITERIA
Development Parcel – Buildings	Provide a minimum finished floor elevation of 104.0 feet (~95 feet 2000 Mean Higher High Water elevation (MHHW) + 100-yr storm surge (100SS) (~3.5 feet) + 66 inches of 2100 High SLR) and/or flood-proof to 2100 High SLR projections for new occupied facilities.
Development Parcel – Parking Structures	The Block D Parking Garage entrances will be set based on the grade of the adjacent street. At a minimum, the garage entrances will be set with a minimum finish floor elevation of 99.83 feet (95 feet 2000 MHHW + 100-yr storm surge + 16 inches of 2065 Mean SLR). As required, Adaptive Management Strategies will be incorporated within the structure to provide resiliency and protection through 2100.
Development – Proposed On-Site Streets	<p>The street elevation shall accommodate 4 feet in general and 2 feet minimum of freeboard between the 5-year storm drain system HGL and the street gutter flow line.</p> <p>For streets with City standard 4-inch to 8-inch tall curbs, the street's lowest top of curb elevation shall be above the HGL for the 100-year storm for the storm drain system. Refer to Section 13.</p> <p>For curbless streets or streets with flush curbs, hydraulic modeling and overland release requirements will be determined during the approval process for the MUPs.</p>
Development Parcel – Pier 48	The pier structure will remain at existing elevation. As SLR occurs, Adaptive Management Strategies may be incorporated within the structure to provide resiliency and protection through 2100, subject to jurisdictional approval.

For adjacent streets serving the project, including 3rd Street and Mission Rock Street, street elevations will remain relatively close to their current elevations. Along the east edge of the project, Terry A Francois Boulevard will be constructed relatively close to its current elevation. Proposed streets within the development will slope up from the existing conform elevations of approximate elevations of 99-101.5 feet at 3rd Street, Terry A Francois Boulevard, Piers 48 and 50, and Mission Rock Street to elevations of approximately 102.9-104.3 feet at the center

of the site. By elevating the center of the site, access can be provided to building finished floors, which are set to accommodate protection from the 2100 High SLR projections.

7.6 Proposed Grading Designs

7.6.1 Building Areas

Proposed finished floors will be set at a minimum of the 100-year tide level plus 66-inches of SLR to ensure protection from anticipated rising tide levels. Project development and grading designs will be developed to comply with the City requirements for ADA accessible paths of travel.

7.6.2 Proposed Roadways

Proposed slopes along public streets and private alleys will be set at a maximum longitudinal slope of 5 percent to provide ADA accessible pathways of travel without requiring handrails as shown in Figure 7.2. The proposed public street system is designed in a saw tooth grading pattern as illustrated in Figure 7.3, such that adjacent high and low points have relatively the same elevations. At conforms, the site slopes down to the existing adjacent streets, China Basin, or park areas. With exception to Channel Street and Channel Lane, which will function primarily as pedestrian zones, handrails will be provided for stairs and accessible areas exceeding 5 percent, where required.

At street intersections, grades will be designed at a maximum slope of 2% to provide an accessible path of travel in crosswalks. In addition, vertical curves within the streets will be designed to both begin and end outside the limits of the crosswalk areas.

7.6.3 Overland Release

As required by the Subdivision Regulations, grading designs will be developed such that the 100-year HGL is contained within the top of curb elevations on opposite sides of a street throughout the Project site. For streets without curbs or with flush curbs, such as Terry A Francois Boulevard, Shared Public Way and the northern block of Bridgeview Street, grading and hydrology designs will be developed to contain the HGL for a 100-year 3-hour storm within the street while both providing a 4-foot wide accessible path on one side of the street and assuming drainage structures within the local drainage area are blocked. The proposed on-site street grid will be graded to provide overland release for the Project. The proposed public street system is designed in a saw tooth grading pattern to facilitate overland flow of stormwater to adjacent streets. The Developer

shall provide all tenants, lessees, and owners adjacent to streets without curbs or with flush curbs with a written disclosure form, as approved by the Port and City, which notifies all such entities of the potential for flooding. The disclosure form also shall be recorded against any property adjacent to streets without curbs or with flush curbs prior to the initial sale or lease of all such properties.

7.7 Proposed Site Earthwork

The conceptual grading plan for the Project will require approximately 75,000 CY of gross earthwork to grade for topsoil within China Basin Park and the pile-supported structured streets. Within China Basin Park, grades will be elevated by a combination of topsoil and Geofoam. Development Parcels and Mission Rock Square may be pile-supported, requiring no additional fill to grade, or elevated using light-weight fill, Geofoam, topsoil, or a combination thereof. To support grading activities, a Storm Water Pollution Prevention Plan (SWPPP) / Erosion and Sediment Control Plan (ESCP) will be submitted in parallel with future grading permits. Grading in conjunction with site remediation efforts will be performed by the Developer.

7.8 Phases of Grading Activities and Approvals

The Developer will grade the site based on the principle of adjacency and as-needed to facilitate a specific proposed Development Phase and consistent with the requirements of the DA, DDA, and IGA. The amount and location of the grading proposed will be the minimum necessary to support the Development Phase. The new Development Phase will conform to the existing grades as close to the edge of the Development Phase area as possible while maintaining the integrity of the remainder of the Project. Repairs and/or replacement of the existing facilities necessary to support the proposed Development Phase will be designed and constructed by the Developer. Interim grading will be constructed and maintained by the Developer as necessary to maintain existing facilities impacted by proposed Development Phases. Project grading activities will comply with City Ordinance 175-91 for use of non-potable water for soil compaction and dust control.

DRAWING NAME: \\BKF-SF\voita\2008\060000_Mission Rock\ENG\Exhibits\Infrastructure Plan Exhibits\Plotted\Shaola\Figure 7.1 Existing Grading Plan.dwg
 PLOT DATE: 07-15-17
 PLOTTED BY: FEL

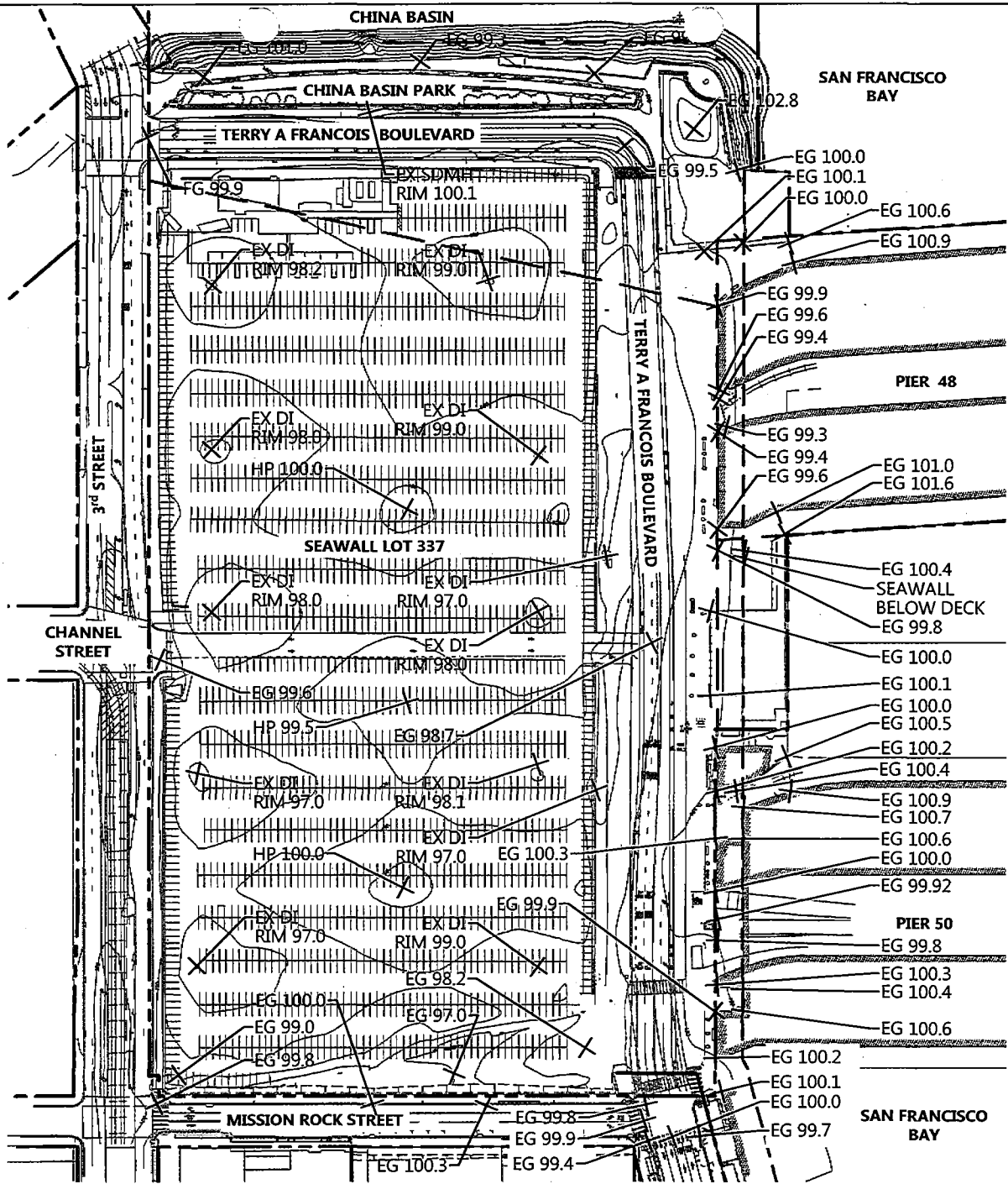

LEGEND

- EXISTING PARCEL LINE
- - - EXISTING CONTOUR

Source: BKF ENGINEERS, 07/2016

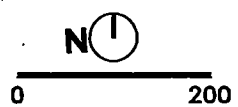

DRAWING NAME: \\BKF-SF\vol14\2008\060000_Mission_Rock\ENG\Exhibits\Infrastructure_Plan_Exhibits\Plotted_Sheets\Figure 7.2 Conceptual Grading Plan.dwg
 PLOT DATE: 07-13-17
 PLOTTED BY: FELL

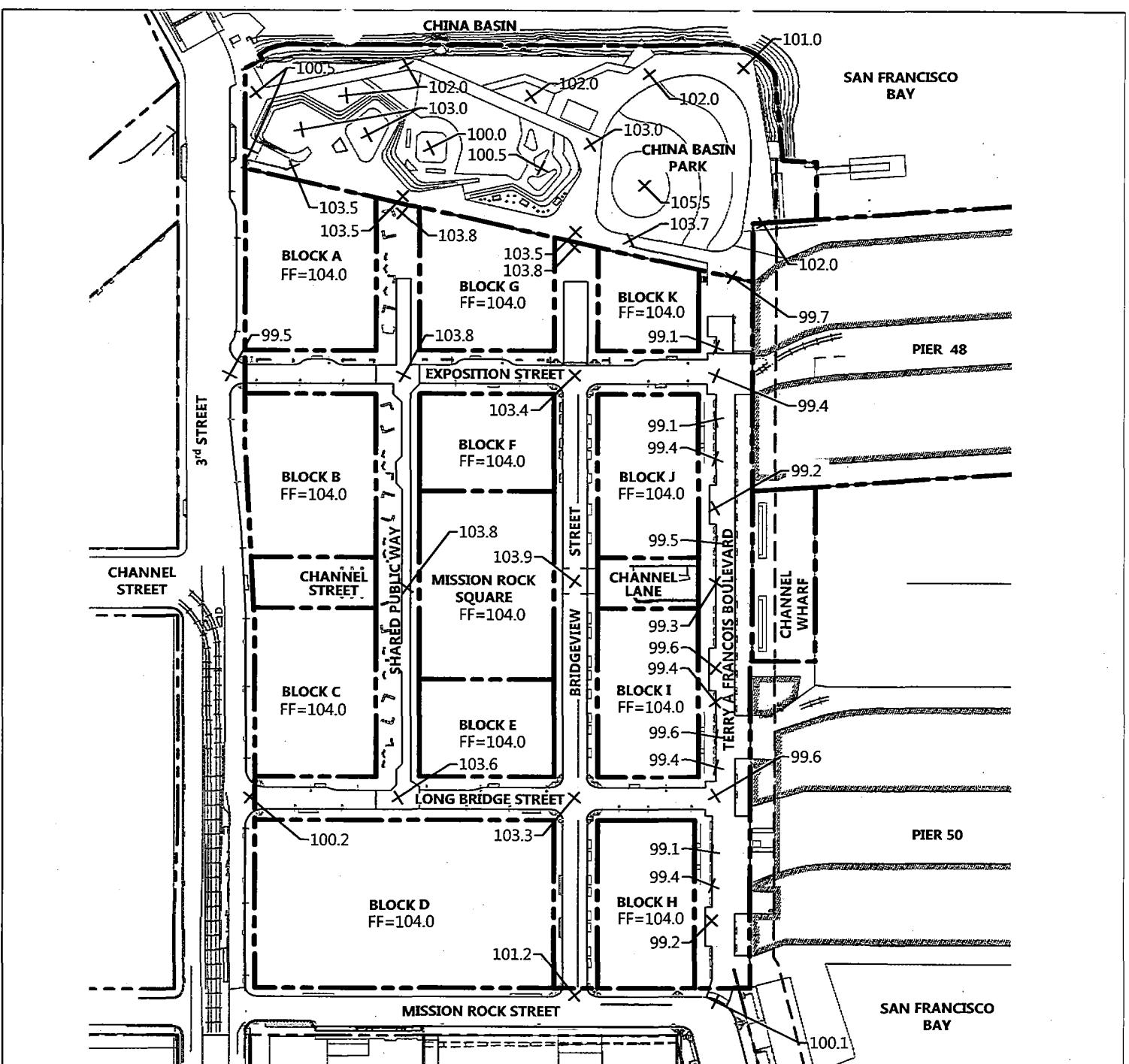

LEGEND

- PROPOSED PARCEL LINE
- - - EXISTING PARCEL LINE
- X
103.6 PROPOSED ELEVATION

NOTE
 ALL ELEVATION ARE BASED ON THE MISSION BAY DATUM. THE MISSION BAY DATUM EQUALS THE OLD CITY OF SAN FRANCISCO DATUM PLUS 100 FEET.

Source: BKF ENGINEERS, 07/2016

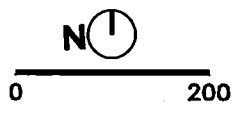

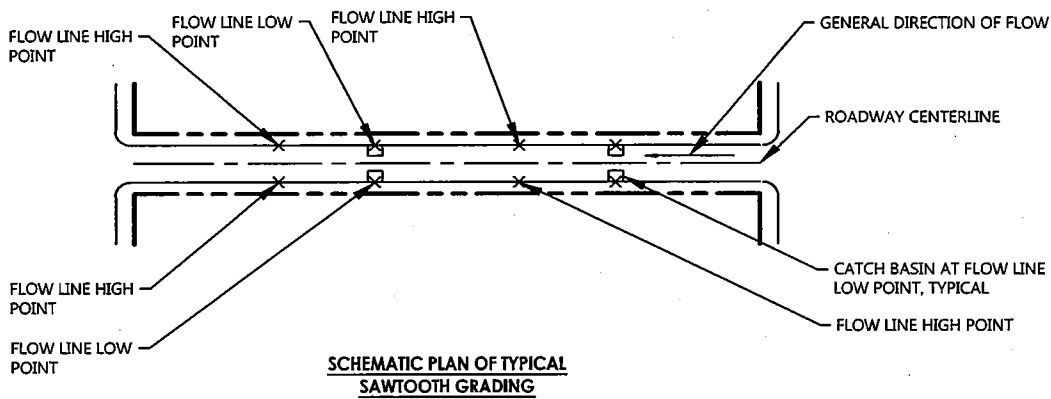

SCHEMATIC PLAN OF TYPICAL SAWTOOTH GRADING

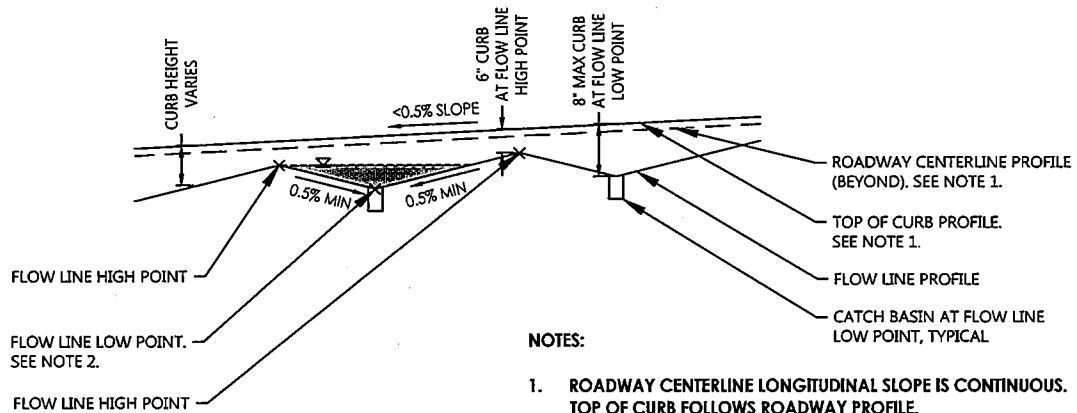

OPTION 1

SCHEMATIC PROFILE OF SAWTOOTH GRADING WITH CONTINUOUS CENTERLINE AND TOP OF CURB

NOTES:

1. ROADWAY CENTERLINE LONGITUDINAL SLOPE IS CONTINUOUS. TOP OF CURB FOLLOWS ROADWAY PROFILE.

STREET CROSS SLOPE VARIES BETWEEN 2% AND 5% AND CURB HEIGHT VARIES BETWEEN 6-INCHES AND 8-INCHES (EXCEPT AT CURB RETURNS, CROSSWALKS, ACCESSIBLE PARKING SPACES, AND ACCESSIBLE PASSENGER LOADING ZONES) TO ACHIEVE A FLOW LINE WITH A 0.5% MINIMUM LONGITUDINAL SLOPE.

2. THE LOW POINT OF THE FLOW LINE COINCIDES WITH THE STEEPEST STREET CROSS SLOPE AND 8-INCH CURB.
3. THE ROADWAY CENTERLINE SLOPE ON TERRY A FRANCOIS BOULEVARD IS LESS THAN 0.5% SLOPE DUE TO EXISTING CONDITIONS.

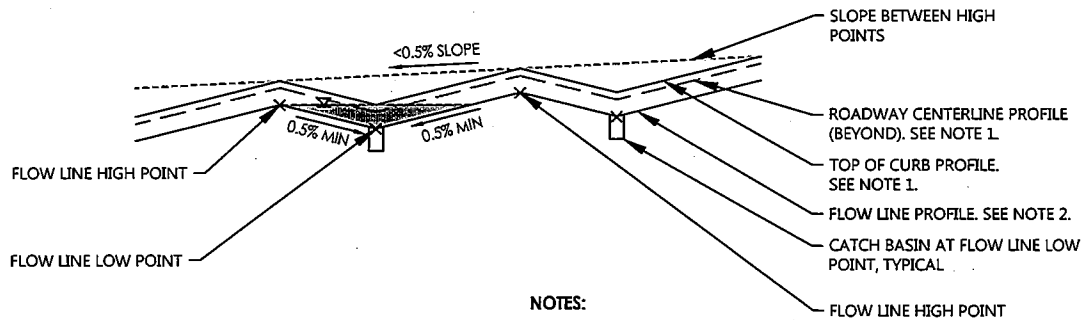

OPTION 2

SCHEMATIC PROFILE OF FLOW LINE SAWTOOTH GRADING WITH PARALLEL ROADWAY CENTERLINE AND TOP OF CURB

NOTES:

1. ROADWAY CENTERLINE PROFILE AND TOP OF CURB FOLLOWS FLOW LINE PROFILE.
2. FLOW LINE HIGH POINT ELEVATIONS ARE LOWER THAN THE UPSTREAM TOP OF CURB LOW POINT ELEVATIONS.
3. THE ROADWAY CENTERLINE SLOPE ON TERRY A FRANCOIS BOULEVARD IS LESS THAN 0.5% SLOPE DUE TO EXISTING CONDITIONS.

DRAWING NAME: \\BKF-SF\vol1\2008\00000000_Mission Rock\ENR\Exhibits\Infrastructure Plan Exhibits\Plotted\Shoofa\Figure 7.3 Street Sawtooth Grading.dwg
PLOT DATE: 07-15-17
PLOT BY: FEL

Source: BKF ENGINEERS, 07/2016

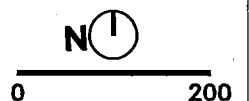

8. STREET AND TRANSPORTATION INFRASTRUCTURE

Mission Rock's street network will be comprised of short, walkable blocks that connect to existing Mission Bay streets adjacent to the Project. The Project will prioritize pedestrian and bicycle safety and access to the buildings, streets, and open spaces at Mission Rock through careful consideration of transit and transportation connections, accessibility, traffic calming measures, and a centralized site parking facility instead of on-street parking. The bicycle network at Mission Rock will provide an important link for the district, connecting the Bay Trail/Blue Greenway to the Embarcadero, and will include a variety of facilities that will provide choices for cyclists of all ages and skill levels. These facilities will be integral to the unique character of Mission Rock's streets.

8.1 Design Controls: Plan Overview

The Design Controls describe the public realm, open spaces, and streetscapes at Mission Rock represented in Figure 8.1. The street designs described herein represent one potential application of these controls. As a pedestrian-priority development, Mission Rock's street network will provide safe and easy access to open spaces, building entrances, and retail, with unique street types designed to the scale and speed of the pedestrian experience. A combination of traffic calming strategies will discourage unnecessary vehicle traffic and ensure that internal traffic will be low-speed and low-volume. The public realm will be fully integrated with the design and scale of the ground floor of Mission Rock's buildings.

8.2 Public Street System

The Developer will be responsible for the design and construction of the public streets. Improvements will generally include the following:

- Pavement structural sections
- Concrete curbs and gutters
- Concrete sidewalk and curb ramps
- Traffic control signage and striping
- Traffic signals
- Street lighting and pedestrian-scale lighting
- Street landscaping and trees
- Stormwater management facilities (may include such methods as landscape strips, permeable pavements, and bio-retention areas)
- Street furnishings (includes, but are not limited to, benches, trash cans and bike support facilities)

- Accessible on-street passenger loading zones with adjacent street level passenger loading aisles and curb ramps.
- Accessible curb ramps
- Accessible Pedestrian Signal (APS) at traffic signal
- Raised crosswalks
- Raised Intersections
- Sidewalk bulb-outs
- Class I and II bikeways
- Enhanced Paving
- Installation of accessible pedestrian signals
- Utility Clearance Requirements

Streetscape and landscape improvements are further defined in Section 8.4 and in the Design Controls. Approval of and responsibility for maintenance and liability for non-standard stormwater treatment facilities shall be as specified in the ICA or future MOU or MOA.

8.2.1 Public Street Layout and Parcelization

A system of street and parcel numbers has been created to facilitate planning and design coordination and is shown on Figure 8.2. The new grid network of public streets includes three streets oriented north to south: the Shared Public Way, Bridgeview Street, and the existing Terry A Francois Boulevard, which will be realigned and reconstructed. Exposition Street and Long Bridge Street will be oriented east to west. Property frontage improvements will result in partial renovation of the existing 3rd Street and Mission Rock Street sidewalks, with bicycle facilities to be coordinated with the City adjacent to Blocks A and H. Typical cross sections for the proposed streets and existing street improvements can be found on Figures 8.5 – 8.12, with streetscape improvements shown on Figures 8.29-8.42.

8.2.2 Roadway Dimensions

Street widths—curb to curb—are designed to accommodate emergency access, utility clearances, bicycle facilities, passenger loading and building servicing, and vehicular access throughout the site. Typical vehicular travel lanes within streets will range from 10-feet to 11-feet in width. Travel lanes are measured from the face of curb or outside edge of bicycle facilities. All streets except the Shared Public Way will provide for two-way traffic and fire access, with street widths varying

from 22 to 34-feet. The Shared Public Way will provide a one-way 12-foot wide vehicular travelway within a Shared Zone that will have 20-foot minimum clearance between streetscape elements to facilitate fire access. All buildings will be Type 1 Construction. Additional roadway dimension information is shown in Figure 8.3 and detailed cross section information can be found on Figures 8.5-8.12, 8.29, 8.31, 8.33, 8.35, 8.37, 8.39, and 8.41.

8.2.3 Structured Streets and Open Space Areas

Due to existing geotechnical constraints that make the Project site susceptible to differential settlement, liquefaction, and lateral spreading when fill is added to the site, the conceptual geotechnical approach is to provide structured street sections that are pile supported in fill areas. Refer to Section 6 for a detailed analysis of the Project's decision-making process for selecting the structured street and open space area approach to mitigating the site geotechnical constraints. Pile-supporting Mission Rock's streets will provide a geotechnically sound foundation for standard street and open space construction that will support the street designs described in Section 8.4, while mitigating the site's tendency for differential settlement.

The proposed structured streets include Exposition Street, Long Bridge Street, Shared Public Way and Bridgeview Street. The proposed open space areas include Channel Street and Channel Lane. Structured street and open space area locations are identified in Figure 8.13. The structured streets and open space areas will be comprised of street pavement and/ or pedestrian concrete paving, landscape, utility infrastructure, and sidewalk improvements built on top of and within structural fill throughout the street sections within the public right-of-way. Subject to the final design, preliminary designs for the concrete slab thickness at the bottom of the structure is conceptually 2-feet thick and walls will potentially be 1 foot thick. The depth of the structured streets will be a minimum of 6-feet deep beneath landscaping to provide sufficient room for tree roots and at least 1 foot deeper than the bottom of the deepest utility pipe per SFPUC vertical clearance requirements. Subdrains, where required based on the final design of the structured streets, will be provided within the structured streets and open space areas to prevent accumulation of water and will drain via a gravity connection or through a sump pump and force main to the sanitary sewer system as described in Section 12. Where a subdrain is required, a sand trap will be installed

in advance of the connection of the SFPUC sanitary sewer main. A preliminary typical structured street cross section is shown on Figure 8.14.

Structured streets and open space areas will be supported by steel H-piles or precast, pre-stressed concrete piles with no down drag. There are two types of pile systems being considered for supporting the structured streets and open space areas. The first consideration is friction-only piles that extend below the Bay Mud sub-layers and gain friction in the clay and sand beneath. The second consideration is a combination of friction plus end-bearing piles which will extend to dense sand or bedrock approximately 100 – 160-feet beneath the bottom of the Bay Mud layers. These preliminary pile-supporting systems are further discussed in Appendix F and are subject to final geotechnical studies and structural designs to be completed as part of the Construction Document process.

The structured streets and open space areas will be integrated within the Project's street grid and conform to existing and reconstructed streets of 3rd Street, Mission Rock Street, and Terry A Francois Boulevard. Final designs to determine pile spacing, depths, waterproofing and drainage will be completed as part of the Construction Document process. The Project will request a design modification or exception to the Subdivision Regulations for interim improvements. The request will be made to the City Department with authority over the interim infrastructure in compliance with the process outlined in the Subdivision Regulations.

8.3 Public Street Modes of Travel and Access

8.3.1 Pedestrian Circulation and Accessibility

Creating a safe, accessible, and comfortable pedestrian experience will be a priority on all streets at Mission Rock, with safe pedestrian street crossings and connections to open spaces and surrounding streets. Mission Rock's three north-south streets will have reduced-height or flush curbs separating the pedestrian realm from the vehicular travelway. In addition to privileging pedestrian access, this strategy will facilitate paratransit vehicle access that can serve all of Mission Rock's Development Parcels and open spaces. Passenger loading and building servicing strategies will be designed to minimize conflicts between pedestrians and vehicles, and to maximize the special streetlife elements that create a rich pedestrian experience.

8.3.1.1 Pedestrian Throughway

On all sidewalks and major pedestrian routes to and within Open Spaces, a pedestrian throughway that is 6-foot minimum in width will be maintained. This throughway is defined as a universally accessible path of travel that does not exceed 5% maximum longitudinal slope and 2% maximum cross slope. See Section 8.4 for mandated minimum widths of pedestrian throughway and circulation routes for specific streets.

8.3.1.2 Access to Development Parcels and Open Spaces

Universal access to and within open spaces shall be provided for significant pedestrian connections, identified on Figure 8.15. Loading zones for passenger loading shall be provided, distributed to enable access to all Development Parcels and open spaces, with priority given to significant pedestrian connections.

8.3.2 Vehicular Circulation

All streets at Mission Rock shall have two-way low-volume, low-speed traffic circulation, with the exception of the Shared Public Way, which shall have one-way traffic in the northbound direction only. Circulation and controlled intersections are shown on Figure 8.16 and described in Sections 8.7 and 8.8.

8.3.2.1 Paseos

Paseos are proposed at the terminus of the Shared Public Way, Bridgeview Street, and Terry A Francois Boulevard at China Basin Park. These paseos shall accommodate Emergency Vehicle Access for a maximum distance of 150-feet from the Exposition Street right-of-way. The terminus of this access shall be clearly marked by permanent site furnishings or street trees. Along Exposition Street, paseos shall include signage and design cues that prohibit access for unauthorized vehicular traffic. Ownership and maintenance and liability for paseos and encroachments thereon shall be addressed as set forth in the ICA or future MOA or MOU.

8.3.2.2 Intersections

All stop-controlled and signalized intersections shall adhere to City standards for signage and street markings. Where crosswalks at uncontrolled intersections are proposed at Open Space connections, an appropriate combination of traffic control strategies, including

crosswalk markings, shall be employed to maximize visibility and safe pedestrian crossing.

Refer to Section 8.8 for more detailed information on intersection design and controls.

8.3.3 Bicycle Circulation

The Mission Rock development is dedicated to improving bicycle transportation throughout the Mission Bay area by implementing the 2009 San Francisco Bicycle Plan and providing infrastructure for improved cyclist safety. In addition to providing a key link within the Bay Trail, between the Blue Greenway south of the site and the Embarcadero north of the site, bicycle lanes of various class designations will be incorporated into the public streets throughout the site. Terry A Francois Boulevard will include the Bay Trail/Blue Greenway, a multi-use trail along the waterfront, as well as sharrows within the Shared Zone. Bridgeview Street and Terry A Francois Boulevard will accommodate the majority of bicycle traffic traveling north and south through the site on protected bicycle facilities or multi-use trails, providing a safer environment that separates bicycles from vehicular traffic and prioritizes bicycle travel. Bridgeview Street and Mission Rock Street will include cycle tracks that are separated from vehicular traffic using mountable curbs, horizontal buffers, or vertical barriers. Bridgeview Street and Terry A Francois Boulevard will accommodate the majority of bicycle traffic traveling north and south through the site on protected bicycle facilities or multi-use trails, providing a safer environment that separates bicycles from vehicular traffic and prioritizes bicycle travel. Figure 8.17 indicates the conceptual strategy for these facilities at a network scale. Refer to Section 8.4 for specific street designs, bicycle facilities, and safety strategies.

8.3.4 Loading, Servicing, and Parking

Loading, servicing, and parking at Mission Rock will be distributed to minimize impact on the public realm pedestrian experience. While no permanent street parking will be provided, passenger loading across the site will be accommodated in dedicated areas. Servicing needs for all of Mission Rock's Development Parcels will be accommodated on Exposition Street, Long Bridge Street, 3rd Street at Parcel A, and Terry A Francois Boulevard in time-limited commercial or dedicated commercial zones. Figure 8.18 describes this conceptual strategy.

8.3.4.1 Passenger Loading

Passenger loading zones are distributed across the public realm, with dedicated accessible passenger loading stalls located on all streets except Bridgeview and Mission Rock Streets.

Refer to the Transportation Plan for more detailed information. Refer to Section 8.4 for streetscape designs, and Section 8.6 for accessible loading stall details.

8.3.4.2 Servicing

Servicing for Development Parcels, including ground floor tenants, will be located in dedicated or time-limited commercial loading zones for deliveries, freight loading, and building servicing. Dedicated commercial loading zones will be provided on Exposition and Long Bridge Streets, and time-limited commercial zones will be located on 3rd Street and Terry a Francois Boulevard.

8.3.4.3 Large Vehicle Access

Exposition and Long Bridge Streets and Terry A Francois Boulevard shall accommodate commercial vehicle circulation. Access to pier sheds, aprons, and valleys shall be maintained for WB-50 trucks to Pier 50, and access to the Pier 48 valley by WB-67 shall be provided; refer to Figures 8.19 and 8.20 for access studies. Commercial vehicle access for trucks that are a maximum size of SU-30 shall be accommodated in time-limited commercial loading zones on the west side of the Terry A Francois Boulevard right-of-way for Working Waterfront tenants; see Section 8.4.

8.3.4.4 Parking and Driveways

Per Chapter 5 of the Design Controls, driveways may be provided for interior servicing of Development Parcels. If provided, driveways to access off street parking on all blocks except D are only permitted on Exposition Street and Long Bridge Street in accordance with Section 7.7. Driveways for the shared parking facility at Block D shall be provided on Long Bridge Street, Bridgeview Street and Mission Rock Street. See Section 8.6 for information regarding placement of driveways relative to streetscape elements.

8.3.4.5 Mission Rock Square Garage

In accordance with the DDA and other Transaction Documents, Port and Developer may determine to develop the underground Mission Rock Square Garage as part of the Project, including associated access improvements and facilities at Channel Street and Channel Lane. The development of the Mission Rock Square Garage, and associated improvements, facilities, and mitigation under the MMRP, is anticipated under the

Transaction Documents and, accordingly, would not constitute a Material Change to this Infrastructure Plan. If Mission Rock Square Garage is proposed for a Phase, prior to the First Submittal of Improvement Plans for that Phase, Developer will: (i) submit and obtain the approvals and consents required for a non-material Infrastructure Plan amendment describing the additional or modified horizontal improvements to be constructed by the Developer to serve the underground Mission Rock Square Garage; and (ii) include the associated Mission Rock Square Garage infrastructure improvements in the applicable Basis of Design documents submitted for that Phase. This provision does not limit the City's obligation to comply with CEQA, in connection with any subsequently proposed modifications to the Mission Rock Square Garage or associated facilities or improvements.

8.3.5 Fire Department Access

Based on the planning efforts undertaken during the Design Controls and meetings with the San Francisco Fire Department, intersection radii, street widths from curb to curb, and right-of-way layouts have been designed to accommodate fire truck turning movements at the Project intersections shown on Figure 8.21. Per the SFFD requirements, intersections are designed to accommodate the truck turning movements of the City of San Francisco 57-foot Articulated Fire Truck (Fire Truck), which is shown on Figure 8.22. Other emergency vehicles turning movements analyzed included the SFFD Engine, SFFD Rescue squad, and a second version of the 57-foot Articulated Truck. The SFFD 57-foot Articulated Fire Truck shown in figures 8.21-8.27 was the most restricted vehicle and thus was the basis for street layout designs. At intersection approaches and within intersections, the Fire Truck may encroach into the opposing vehicular travel lane to complete turning movements, but a minimum of 7-feet of refuge area is provided for any cars within these lanes. Figures 8.23-8.27 show enlargements of the fire truck turning movements for the San Francisco 57-foot Articulated Fire Truck at the site intersections.

8.4 Public Street Network and Hierarchy

The Mission Rock street network will include several street types with distinctive character, planting, traffic speed, and streetlife elements – site furniture, street trees, special paving, and understory planting that combine with active ground floor uses to enrich the pedestrian experience. These street types include:

- Shared Public Way: A pedestrian-oriented shared street with one-way, low-speed, low-volume traffic (Shared Public Way, 8.29-8.30).

- Working Waterfront: A shared street with two-way, low-speed, low-volume traffic that integrates industrial and maritime uses with the Blue Greenway (Terry A Francois Boulevard, 8.31-8.32).
- Neighborhood Street: Streets with generous sidewalks, stormwater treatment gardens, and slow traffic; vehicular travelway curb-separated from sidewalk; must include sharrows, standard bicycle lanes, or protected bicycle facilities (Bridgeview Street, 8.33-8.34; Exposition Street, 8.35-8.36; and Long Bridge Street, 8.37-8.38).
- Paseo: Non-vehicular street connection adjacent to China Basin Park that accommodates emergency vehicle access (Bridgeview Street, Terry A Francois Boulevard, and the Shared Public Way).
- District Street: Streets referencing OCII Mission Bay design standards that include sidewalk and bicycle improvements only (3rd Street, 8.39-8.40; Mission Rock Street, 8.41-8.42)

8.4.1 Street Zones and Designs

The streets will contribute to a varied public realm while satisfying above- and under-ground infrastructure needs at Mission Rock. Proposed streets largely conform to the 2015 Subdivision Regulations, with exceptions noted in Section 8.4.2: Street Designs. The public right-of-way must be open to the sky with the exception of permitted landscape and street-wall encroachments per the Design Controls, Sections 3.8, 4.3, and 6.3.5, and publicly accessible at all times unless subject to maintenance, operations, security and safety rights, or closure by Master Developer for events. Street closure by Master Developer or others shall be subject to all applicable City and Port permitting and authorizations. Ownership and maintenance and liability for streetscape elements and encroachments shall be addressed as set forth in the ICA or future MOA or MOU for the following: on the Shared Public Way, including, but not limited to the Buffer/Furnishing Zone, Frontage Zone, Street Rooms, Tree Groves, and non-standard design features, such as lighting, stormwater gardens, and other stormwater treatments; on Terry A. Francois Boulevard, including but not limited to the Buffer/Furnishing Zone and non-standard design features; on Bridgeview Street, including but not limited to the Streetlife Zone and non-standard design features; on Exposition Street, including but not limited to the Streetlife Zone and Stormwater Zone; on Long Bridge Street, including but not limited to the Streetlife Zone and stormwater treatment; on 3rd Street, including but not limited to the

Streetlife Zone; on Mission Rock Street including but not limited to the Streetlife Zone.

8.4.1.1 Street Zones: General Definitions

The overall dimension of each streetscape is divided into several sidewalk and roadway zones. The following zones apply to the pedestrian realm of all streets:

- Frontage Zone: A zone along building frontages for Active Edge uses such as seating, signage, and merchandizing, a portion of the public realm that a ground floor building is permitted and encouraged to occupy, as defined in Chapter 5 of the Design Controls.
- Pedestrian Throughway: An unobstructed path of travel for pedestrians that is 6-foot minimum in width and universally accessible, with longitudinal slopes not to exceed 5% maximum.
- Streetlife Zone: A zone within the sidewalk that houses streetscape elements such as trees, lighting, furnishings, and stormwater gardens; equivalent to a Furnishing Zone as defined in the 2015 Subdivision Regulations. See 8.4.1.3.
- Stormwater Treatment Zone: A zone at sidewalk grade on Exposition and Long Bridge Streets where large feature stormwater treatment gardens are proposed within the right-of-way.
- Loading Zone: A zone where temporary spaces for passenger loading and building servicing will be provided. See Figure 8.18 for locations.

The following zones apply to the roadway of Bridgeview, Exposition, Long Bridge, 3rd, and Mission Rock Streets:

- Loading Zone: A zone where temporary spaces for passenger loading and building servicing will be provided.
- Travel Lanes
- Bicycle Facilities

The following zone applies to the Shared Public Way and Terry A Francois Boulevard:

- Shared Zone: The Shared Zone will be shared by pedestrians and vehicles and will be flush with the pedestrian realm. The vehicular travelway will be located between pedestrian-only areas, and defined by visual and tactile detection

cues, site furniture, and designed in accordance with applicable accessibility codes and guidance to ensure pedestrian safety. Crosswalks will be marked at regular intervals.

8.4.1.2 Street Markings

Street markings shall be in accordance with City and Port standards for street and intersection markings. See Section 8.8.

8.4.1.3 Streetlife Zone: Elements

Each street will include a Streetlife Zone, equivalent to a Furnishing Zone as defined by the 2015 Subdivision Regulations, which will include the following elements:

- Tree Planting. Trees should be adapted to the particular microclimate and shade conditions of each street, and sited with consideration of localized wind conditions and City spacing requirements. See Section 8.5.3 for street tree palette, distribution, and species attributes.
- Street Furnishings. Street furnishings, located in the Streetlife Zone, should contribute to wayfinding and identity of each street, and should be a mix of fixed and flexible, movable elements in accordance with specific standards and guidelines for each street. These performance criteria are provided in lieu of a specific palette:
 - Seating. Seating should be an inviting element allowing visual permeability and social use. Special street furnishings are encouraged to emphasize each street's unique character.
 - Accessibility. All street furnishings should be universally accessible, or modifiable to meet or exceed CBC and CAL-DAG minimum requirements.
 - Trash Receptacles. Trash receptacles should be standardized across the site. Location of selected receptacles should not impede visual access or mobility.
 - Bicycle Parking. Bicycle parking shall be provided at building and park entries within the Streetlife Zone as described on each street. Bicycle

racks should be standardized on all internal site streets, with the exception of Bridgeview Street.

8.4.2 Street Designs

8.4.2.1 Shared Public Way

The Shared Public Way is proposed to be a major pedestrian route linking important site anchors such as Mission Rock Square and China Basin Park to site arrival points for MUNI, vehicles, and bicycles, as well as the main site parking garage on Block D. Shared Public Ways are curbless streets that privilege pedestrian movement, following traditional street planning approaches in Europe and other pedestrian-friendly urban centers. The Shared Public Way at Mission Rock will be a dynamic space with active ground-floor retail, street rooms, stormwater gardens, and tree groves that will create a lively and unique environment. These design elements will also serve as cues to differentiate pedestrian-dedicated areas from the shared pedestrian/vehicular zone. Vehicles on the Shared Public Way will be limited to low-volume, low-speed, one-way northbound travel for drop-off, pickup, and deliveries, with traffic volumes not anticipated to exceed 100 vehicles per hour. The Shared Public Way will include the following zones as shown in Figures 8.29 and 8.30:

8.4.2.1.1 Shared Public Way: Active Edges

Active Edges will be located along the retail frontages on both sides of the Shared Public Way and will include the following zones:

- A) Pedestrian Throughway: An unobstructed, 6-foot-minimum clear width path of travel for pedestrians shall be maintained within the Active Edges on both sides of the ROW.
- B) Furnishing Zone: A 6-foot-maximum width zone for furniture, signage, and merchandizing with tree planting shall be included in the 12' active edge on the east side of the ROW.
- C) Frontage Zone: A 2-foot-maximum zone shall be maintained for furniture, signage, and merchandizing on the west side of the ROW.

8.4.2.1.2 Shared Public Way: Streetlife Zone

The Streetlife Zone will be a 20-foot-maximum width zone located along the Shared Zone for its entire length. This zone will provide for safe east-west connections across the ROW. This zone shall include:

- A) Street Rooms: Special landscape areas with non-standard paving, built-in furniture, and ample space for flexible seating, small newsstands, and temporary kiosks.
- B) Tree Groves: Finely textured tree groves that provide dappled shade and enclosure along the entire Shared Public Way. See Section 8.6.
- C) Stormwater Gardens: Stormwater treatment infrastructure that functions ecologically, aesthetically, and programmatically, designed to maximize permeability of movement and view and to encourage lingering, with integrated seating. See Sections 8.6 and 16.

8.4.2.1.3 Shared Public Way: Shared Zone

The Shared Zone shall be consistently a 20-foot-minimum clear zone shared by pedestrians and vehicles. It shall include a non-meandering 12 to 20-foot wide travel lane. Two 8-ft wide passenger loading spaces with clear zones are provided adjacent to the 12-ft travel lane at Blocks E and F to serve retail and open space uses along the street; otherwise, the 12-foot travelway will be bordered by an 8-ft wide area free of streetscape elements to provide 20-ft clear width for emergency vehicle access. Vehicular-accessible areas will be separated from dedicated pedestrian-only areas with visual and tactile detection cues. Crosswalks shall be marked at regular intervals. The Shared Zone shall include:

- A) One-way Traffic: Vehicular traffic shall be permitted one-way northbound, from Long Bridge Street to Exposition Street. North of Exposition Street, the street becomes a paseo; emergency vehicle access only shall be permitted on the paseo between Blocks A and G. No vehicular access is permitted to the Shared Public Way from Channel Street. The Shared Public Way may be closed to vehicular traffic during special events.

- B) Delineated Loading Areas: Paving and demarcation of 8-foot wide passenger loading zones shall be distinct from the 12'-wide vehicular travel lane. See Figure 8.56.

8.4.2.1.4 Shared Public Way: Vehicular Intersections

Raised intersections with visual/tactile detection marking the pedestrian route shall be provided at Exposition and Long Bridge Streets and will comply with applicable accessibility guidance. Refer to traffic calming design described in Sections 8.6 and 8.8.

8.4.2.1.5 Shared Public Way: Visual/Tactile Detection Cues

Visual/Tactile Detection Cues shall differentiate the Shared Zone travel lane and loading zones from dedicated pedestrian areas; these shall be coordinated in consultation with applicable codes and accessibility guidance and include the following:

- A) Paving Strategies: Material tactics, including contrasting paving color, texture, or material type, shall ensure safe pedestrian connections across the Shared Zone. These cues shall delineate the Shared Zone for its entire length. Also see 8.5.2 and Figures 8.44-8.45.
- B) Spatial Cues: Incorporate design and spatial cues such as a 'gateway' to the Shared Zone from Long Bridge Street -- a constricted entry point with physical elements that will provide a visual/physical cue for drivers to slow down. Raised intersections at Long Bridge and Exposition Street are proposed in order to maximize pedestrian safety and visibility. Additional spatial cues are described in Section 8.6: Traffic Calming Design.

8.4.2.1.6 Shared Public Way: Non-Standard Curbs and Drainage

The Shared Public Way is curbless on both sides of the vehicular-accessible 20-ft wide Shared Zone, which is not in conformance with the Subdivision Regulations. A linear drainage element for the inverted crown street, which is described in greater detail in Sections 10 and 13, will convey surface runoff. A design modification and exception or an Encroachment Permit will be requested of the

Acquiring Agency for construction of the inverted crown street during the permitting process for the street improvements. See Figure 8.29 and Section 8.6.

8.4.2.2 Terry A Francois Boulevard

Terry A Francois Boulevard will be a unique Working Waterfront that supports active maritime, industrial, and production uses on the waterfront. Terry A Francois Boulevard will also connect the Bay Trail/Blue Greenway to China Basin Park and the Embarcadero to contribute to uninterrupted public access along San Francisco's eastern waterfront. Connecting the Mission Rock development to its active and historical maritime context, the expression of craft and industrial character along Terry A Francois Boulevard will be central to the personality and experience of this working waterfront. Terry A Francois will include the following zones, shown in Figures 8.31 and 8.32:

8.4.2.2.1 Terry A Francois Boulevard: Waterfront Zone

Located adjacent to Pier 48, Pier 50, and Channel Wharf, the Waterfront Zone shall include the following zones within a minimum cumulative width of 22-feet, measured from Pier 50:

- A) Bay Trail/Blue Greenway: A multi-use trail located along the east side of the entire Terry A Francois Boulevard ROW, with a 16-foot-minimum clear path of travel for bikes and pedestrians.
- B) Buffer/Furnishing Zone: A 3-foot-minimum width buffer comprised of furnishings and iconic lighting, located along the entire length of the Shared Zone. This zone will have contrasting paving and other cues to be coordinated with applicable accessibility codes and guidance.

8.4.2.2.2 Terry A Francois Boulevard: Shared Zone

The Shared Zone will be a 26-foot-minimum width zone with two-way traffic that is shared by pedestrians and vehicles from Mission Rock Street to Exposition Street. The Shared Zone will be separated from the Waterfront Zone and the Building-Front Zone with flush curbs per 8.4.2.2.7 and Buffer/Furnishing Zones per 8.4.2.2.1-B and 8.4.2.2.3-B.

8.4.2.2.3 Terry A Francois Boulevard: Building-Front Zone

The Building-Front Zone shall be contained within a maximum width of 24-feet adjacent to Blocks H, I, and J. The Building-Front Zone will include:

- A) Pedestrian Throughway: A 12-foot-minimum width pedestrian area with 6-foot minimum clear path of travel at street grade along Blocks H, I, and J.
- B) Encroachments: Where an Elevated Walkway is provided within the property line of the adjacent Development Parcels per Chapter 5 of the Design Controls, a 6-foot-maximum width encroachment within the right-of-way shall be provided to accommodate accessible circulation to the Elevated Walkway and a dock lift or similar apparatus at the building face to serve ground floor tenants.
- C) Buffer/Furnishing Zone: A 3-foot-minimum width buffer comprised of furnishings, located along the entire length of the Shared Zone. This zone will have contrasting paving and other visual/tactile detection cues for pedestrians, to be coordinated with applicable accessibility codes and guidance.
- D) Loading Area: A 9-foot-wide loading area that accommodates a maximum truck size of WB-30, located adjacent to the Shared Zone at Blocks H, I, and J. See Figure 8.55.
- E) Streetlife Zone: A 9-foot-wide dedicated pedestrian spill-out space, located adjacent to the loading area.

8.4.2.2.4 Terry A Francois Boulevard: Paseo North of Exposition Street

Between Block K and Pier 48, Terry A Francois Boulevard will become a paseo that will accommodate emergency vehicle access for up to 150-feet of its length, with the terminus of this access marked by permanent street furnishings. The paseo will include the following zones:

- A) Waterfront Zone at Pier 48: A 28-foot-wide zone, located adjacent to the Pier 48 bulkhead, shall accommodate the Bay Trail/Blue Greenway per 4.3.1-A) and additional public space for Pier 48.
- B) Vehicular Turnaround + Loading Spaces: A vehicular turnaround with

passenger loading spaces, accessed from the Shared Zone.

- C) Pedestrian Throughway: A 6-foot-minimum clear path of travel for pedestrians, located along Block K.

8.4.2.2.5 Terry A Francois Boulevard: Vehicular Intersections

Flush intersections with visual/tactile detection marking the pedestrian route shall be provided at Exposition and Long Bridge Streets. An uncontrolled, marked intersection shall be provided at the pedestrian crossing between Channel Lane and Channel Wharf. These will comply with applicable accessibility guidance. Aural warnings will be integrated within paving adjacent to intersections.

8.4.2.2.6 Terry A Francois Boulevard: Streetscape Elements

Streetscape elements are an important aspect of experience and character of Terry A Francois Boulevard.

- A) Placement: Streetscape elements shall be placed within the Buffer Zones at regular intervals as determined by applicable accessibility guidance. Additional permanent streetscape elements in the Waterfront or Building-Front Zones, if desired, shall not block throughway areas or impede circulation along Terry A Francois Boulevard.
- B) Expression of Production Character: Street furnishings, especially benches, along Terry A Francois Boulevard shall express the industrial character of the Working Waterfront Typology. Industrial and salvaged materials are strongly encouraged for these elements.
- C) Consistency of Elements: Trash receptacles and bicycle racks shall be consistent for the length of this streetscape. Benches may be varied.

8.4.2.2.7 Terry A Francois Boulevard: Non-Standard Curbs and Drainage

Terry A Francois Boulevard has flush curb conditions on both sides of the vehicular-accessible Shared Zone, with flush intersections at Long Bridge and Exposition Street, which are not in conformance with the Subdivision Regulations. Additionally, a linear drainage element, which is described in greater detail in Sections 10 and 13, along the flush curb condition will convey surface runoff. A

design modification and exception or an Encroachment Permit will be requested of the Acquiring Agency for construction of the linear drainage element during the permitting process for the street improvements.

8.4.2.3 Bridgeview Street

Bridgeview Street will be a Complete Street with dedicated bicycle infrastructure, active sidewalks, stormwater treatment gardens, and low-speed, low-volume vehicular traffic. An important north-south bicycle connection from China Basin Park to Mission Bay, Bridgeview Street will integrate protected bicycle facilities into the life and character of the street. Bridgeview Street will include the following zones, shown in Figures 8.33 and 8.34:

8.4.2.3.1 Bridgeview Street: Sidewalk Zones

Sidewalks on Bridgeview Street shall be 14-feet-wide along the east side of the right-of-way, and 12-feet wide along the west side of the right-of-way. The sidewalk shall include:

- A) Frontage Zone: A 2-foot-maximum width zone shall be maintained along building frontages for furniture, signage, and merchandizing.
- B) Pedestrian Throughway: An unobstructed, 6-foot-minimum clear width path of travel for pedestrians, with width as noted on Figure 8.33, shall be maintained between the Frontage Zone and the Streetlife Zone.
- C) Streetlife Zone: A zone between the curb and pedestrian throughway with width as noted on Figure 8.33. This zone shall include trees, lighting, and furnishings that shall be consistent for the entire length of the street. Stormwater treatment gardens shall be included in the Streetlife Zone with minimum area as noted in Section 16.
- D) Driveway Restrictions: Driveways shall not be permitted, except at the Block D parking garage.

8.4.2.3.2 Bridgeview Street: Roadway Zones

The 34-foot-wide roadway will accommodate two-way vehicular traffic from Exposition Street to Mission Rock Street and will include:

- A) **Bicycle Facility:** A two-way Class 1 cycle track with total width of 10-feet on the east side of the right-of-way, including two 5-foot-wide lanes. This facility shall be protected from vehicular traffic with a 3-foot-wide horizontal buffer that is flush with the cycle track surface. This horizontal buffer will include a mountable curb that grade-separates the facility from the adjacent vehicular travelway. Approved safe-hit posts that are 46-inches in height shall be provided in this area.
- B) **Travel Lanes:** Two 10.5-foot-wide travel lanes shall be provided to accommodate two-way vehicular traffic.

8.4.2.3.3 Bridgeview Street: Paseo North of Exposition Street

Between Block G and Block K, Bridgeview Street will become a paseo that will accommodate emergency vehicle access for up to 150-feet of its length with the terminus of this access marked by permanent street furnishings or street trees. The paseo will include the following zones:

- A) **Multi-Use Trail Connection:** A 16-foot-minimum clear multi-use trail shall connect China Basin Park to the Class 1 bicycle facility. This connection shall include paving and signage delineating this shared use path and warning cues for pedestrians and cyclists at crossings.
- B) **Emergency Vehicle Clear Access Width:** A 20-foot-minimum clear zone shall accommodate emergency vehicle access for up to 150 feet, measured from the Exposition Street right-of-way.
- C) **Pedestrian Throughway:** A 6-foot-minimum clear path of travel for pedestrians shall be provided on the east and west sides of the right-of-way.

8.4.2.3.4 Bridgeview Street: Traffic Control and Calming Measures

The intersections of Bridgeview Street with Mission Rock and Exposition Streets will have full stop control. The intersection at Long Bridge Street will be a raised intersection at cycle track grade with two-way stop control for Long Bridge, but no stop control for Bridgeview Street bicycle or vehicular traffic. See Section 8.8. A raised mid-block crosswalk at the intersection of Bridgeview Street, Mission Rock

Square, and Channel Lane shall be included. Bicycle facility treatment shall continue across the intersection, with signage to yield to pedestrians. See Figures 8.63, 8.65, and 8.67.

8.4.2.3.5 Bridgeview Street: Bicycle striping, signage, and wayfinding

Bicycle Signage and Wayfinding should refer to City, Port, and NACTO (National Association of City Transportation Officials) Urban Bikeway Standards. Signage should be mounted at the curb edge of the Streetlife Zone, or inset in bicycle facility paving. Before all intersections and at the northern paseo portion of Bridgeview Street, the cycle track shall include paved and signed warning cues for pedestrian crossings. Cycle track demarcation shall continue across intersections at Exposition and Long Bridge Streets to indicate that cyclists have the right-of-way. Signs should indicate that vehicles must yield to cyclists.

8.4.2.3.6 Bridgeview Street: Non-Standard Curbs and Drainage

Bridgeview Street has a raised cycle track with a mountable curb separating the cycle track from the vehicular travel way, and a 4-inch curb separating the cycle track from the sidewalk on the east side of the street; these are not in conformance with the 2015 Subdivision Regulations.

8.4.2.4 Exposition Street

Exposition Street is designed to calm traffic and create a lush pedestrian connection with bulb-out gardens that will treat stormwater and provide seating. It will also accommodate service and loading demands for Blocks A, B, F, G, J, and K. Exposition Street will include the following zones, shown in Figures 8.35 and 8.36:

8.4.2.4.1 Exposition Street: Sidewalk Zones

Sidewalks on Exposition Street shall be 14-feet-wide along the south side of the street, and 20-feet wide along the north side, with inset loading zones for passenger loading and servicing access. The sidewalk shall include:

- A) Frontage Zone: A 2-feet-maximum width zone shall be maintained along building frontages for furniture, signage, and merchandizing.

- B) Pedestrian Throughway: An unobstructed, 6-foot-minimum clear width path of travel for pedestrians, with width as noted in Figure 8.35, shall be maintained between the Frontage Zone and the Streetlife Zone.
- C) Streetlife Zone: A zone between the curb and pedestrian throughway with width as noted on Figure 8.35. This zone shall include trees, lighting, stormwater treatment gardens, and furnishings that shall be consistent for the entire length of the street.
- D) Stormwater Zone: An 8-foot-wide zone between the Streetlife Zone and Roadway on the north side of the right-of-way, at grade with the sidewalk, shall include large stormwater treatment gardens with unique integral seating located at the southeast and southwest corners of Blocks A, G, and K.

8.4.2.4.2 Exposition Street: Roadway Zones

The 26-foot-wide roadway will accommodate two-way vehicular traffic from 3rd Street to Terry A Francois Boulevard, and shall include:

- A) Bicycle Facilities: A 5-foot-wide painted Class II bike lane in the westbound direction, separated from vehicular traffic with a 6-inch-wide solid white line. Minimize utility covers and material transitions in this area. This facility shall be located 1-foot from the face of the adjacent curb. Eastbound sharrows shall be provided.
- B) Loading Zone: An 8-foot-wide zone shall be provided at grade with the roadway, located between stormwater treatment gardens described in Figure 8.36, to provide passenger loading and servicing access. See Section 8.5.6 and Figures 8.18 and 8.54.
- C) Travel Lanes: Two 10-foot-wide travel lanes shall be provided to accommodate two-way traffic.

8.4.2.4.3 Exposition Street: Traffic Control and Calming Measures

The intersection of Exposition Street with Bridgeview Street shall have full stop control for bicyclists and vehicles. At the Shared Public Way and Terry A Francois Boulevard, there shall be stop-controlled raised or flush intersections with

pedestrian throughway clearly delineated by crosswalks. At intersections, bicycle lane treatment shall continue across intersections at Bridgeview Street and the Shared Public Way. See Section 8.8 and Figures 8.63 and 8.66.

8.4.2.4.4 Exposition Street: Large Vehicle Circulation

Large vehicle circulation to and from Terry A Francois Boulevard and Pier 48 shall be accommodated on the roadway between Blocks K and J. See Figures 8.22-27.

8.4.2.5 Long Bridge Street

Long Bridge Street will be an important pedestrian entry point to the site from MUNI on 3rd Street. It is designed with wide throughways, shade trees, ample street furniture opportunities, and compact linear stormwater gardens. Long Bridge Street will accommodate service and loading demands for Blocks C, D, E, H, and I and will be the vehicular entry point for the Shared Public Way. Long Bridge Street will include the following zones, shown in Figures 8.37 and 8.38:

8.4.2.5.1 Long Bridge Street: Sidewalk Zones

Sidewalks on Long Bridge Street shall be 15-feet-wide on both sides of the right-of-way. The sidewalk will include:

- A) **Frontage Zone:** A 2-foot-maximum width zone shall be maintained along building frontages for furniture, signage, and merchandizing.
- B) **Pedestrian Throughway:** An unobstructed, 8-foot-clear width path of travel for pedestrians shall be maintained between the Frontage Zone and the Streetlife Zone.
- C) **Streetlife Zone:** A 5-foot-wide zone between the curb and pedestrian throughway with width as noted on Figure 8.37. This zone shall include trees, lighting, stormwater treatment gardens, and furnishings that shall be consistent for the entire length of the street.
- D) **Bulb-Out with Stormwater Treatment:** A 4-foot-maximum width bulb-out that includes stormwater treatment gardens shall be provided on the north side of Long Bridge Street, on either side of the Shared Public Way intersection.

8.4.2.5.2 Long Bridge Street: Roadway Zones

The 30'-wide roadway will accommodate two-way vehicular traffic from 3rd Street to Terry A Francois Boulevard, and will include:

- A) **Loading Zone:** An 8-foot-wide loading zone shall be provided at grade with the roadway on the north side of the right-of-way, to provide passenger loading and building servicing access. This zone shall be painted with a unique surface treatment that differentiates it from the travel lanes. This zone shall not interfere with fire truck access or turning movements at intersections. Refer to Transportation Plan for loading and servicing strategies.
- B) **Travel Lanes:** Two 11-foot-wide travel lanes shall be provided to accommodate two-way traffic.
- C) **Bicycle Markings:** East- and west-bound sharrows shall be provided.

8.4.2.5.3 Long Bridge Street: Traffic Control and Calming Measures

The intersection of Long Bridge Street with Bridgeview Street shall have stop control for all Long Bridge Street traffic only. At the Shared Public Way and Terry A Francois Boulevard, there shall be stop-controlled raised intersections with pedestrian throughway clearly delineated by crosswalks. See Section 8.8.

8.4.2.5.4 Long Bridge Street: Driveways at Block D Parking Facility

Driveways shall be provided at the Block D parking facility to accommodate ingress and egress. Refer to Transportation Plan.

8.4.2.6 3rd Street

3rd Street is Mission Rock's gateway to Mission Bay. A wide multi-modal street, its character is fundamentally different from the interior streets of Mission Rock. South of Long Bridge Street, the sidewalk is a key threshold into Mission Rock from the MUNI station at Mission Rock Street. 3rd Street will adhere to approved San Francisco Office of Community Investment and Infrastructure (OCII) Mission Bay standards or approved substitutions for paving materials, trees, street furniture, and lighting. 3rd Street will include the following zones, shown in Figures 8.39 and 8.40:

8.4.2.6.1 3rd Street: Sidewalk Zones

The sidewalk on 3rd Street will be 12-feet-wide as shown in Figure 8.39 and will include:

- A) Pedestrian Throughway: An unobstructed, 6-feet-minimum clear width path of travel for pedestrians shall be maintained between the building façade and the Streetlife Zone.
- B) Streetlife Zone: A zone between the curb and pedestrian throughway with width as noted on Figure 8.39. This zone shall include trees, lighting, stormwater treatment gardens, and furnishings that shall be consistent for the entire length of the street.

8.4.2.6.2 3rd Street: Roadway Zones at Block A

At Block A only, the following shall be provided:

- A) Loading Zone: An 8-foot-wide zone shall be provided at grade with the roadway to provide passenger loading and servicing access per Figure 8.18.
- B) Bicycle Facility: A 6-foot-wide painted Class II bike lane in the north-bound direction, separated from vehicular traffic with a 6-inch-wide solid white line.

8.4.2.6.3 3rd Street: Emergency Vehicle Access Radii

Vehicular turning radii from Long Bridge Street and Exposition Street onto Third St have minimum requirements for emergency vehicle access. Refer Figures 8.21-8.27 for truck turning analysis.

8.4.2.7 Mission Rock Street

Mission Rock Street will provide an important link to the Blue Greenway at the terminus of Bridgeview Street. The Block H frontage will incorporate bicycle facilities connecting Bridgeview Street to the Blue Greenway on Terry A Francois Boulevard. Mission Rock Street will adhere to approved San Francisco Office of Community Investment and Infrastructure (OCII) Mission Bay standards or approved substitutions for paving materials, trees, street furniture, and lighting. South of Block H, a contraflow Class 1 cycle track will connect cyclists from Bridgeview Street to Terry A Francois Boulevard's Blue Greenway

infrastructure. Sidewalk improvements will extend along the north side of the right-of-way from Terry A Francois Boulevard to 3rd Street. Mission Rock Street will include the following zones, shown in Figures 8.41 and 8.42:

8.4.2.7.1 Mission Rock Street: Sidewalk Zones

Sidewalk improvements on Mission Rock Street shall be 12-foot-wide, on the north side of the right-of-way, as shown in Figure 8.41. The sidewalk shall include:

- A) **Frontage Zone:** A 2-foot-maximum width zone shall be maintained along building frontages for furniture, signage, and merchandizing.
- B) **Pedestrian Throughway:** An unobstructed, 6-foot-minimum clear width path of travel for pedestrians shall be maintained between the building frontage and the Streetlife Zone.
- C) **Streetlife Zone:** A zone between the curb and pedestrian throughway with width as noted on Figure 8.41. This zone shall include trees, lighting, and furnishings that are consistent for the entire length of the street. Refer to OCII Mission Bay Standards.
- D) **Driveways:** Driveways shall be permitted at the Parcel D parking garage.

8.4.2.7.2 Mission Rock Street: Bicycle Facilities

- A) **Bicycle Facility:** A two-way Class 1 cycle track with total width of 10 feet measured from the face of curb on the north side of the right-of-way, from Bridgeview Street to Terry Francois Boulevard. This facility shall be protected from vehicular traffic with a raised buffer that is a minimum of 15-inches in width, 6 inches in height, and includes a 46-inches-high permanent vertical buffer. This buffer will be segmented to permit drainage. Installation of the raised buffer is adjacent to an existing low pressure water main and will require an agreement between the SFMTA and SFPUC regarding the disposition of the existing water main that will be coordinated during the permitting process.
- B) **Cycle Track Warning Cues:** At intersections, the cycle track shall include paved and signed warning cues indicating pedestrian crossings and vehicular intersections.

- C) Cycle Track Intersections: Cycle track demarcation shall continue across intersections at Bridgeview Street and Terry Francois Boulevard to indicate the primary bicycle route.
- D) Reduced-width travel lanes: existing travel lanes on Mission Rock Street will be narrowed to 10-foot wide. Proposed changes to existing roadway striping will be coordinated at a future date with SFMTA.

8.5 Components of Public Streets

8.5.1 Curb Heights

A variety of curb types will be installed throughout the site. Mission Rock Street, 3rd Street, Long Bridge Street and Exposition Street improvements will consist of crowned asphalt roadway and six-inch curb and gutter on either side. Terry A Francois Boulevard will have flush curb for optimal pedestrian access. Shared Public Way and the northern end of Bridgeview are curbless streets with continuous paving across the right-of-way. Overland release and stormwater drainage information for curbless streets can be found in Section 7: Site Grading and Section 13: Storm Drainage System, respectively. Bridgeview Street will utilize both mountable curb as well as four-inch and six-inch curb and gutter. The mountable curb will delineate the class I cycle track bicycle facility from the vehicular travel lanes and the four-inch curb and gutter will elevate the adjacent landscape and sidewalk above the bike lanes. Curb height design exception and modification requests subject to the process outlined in the City Subdivision Regulations will be reviewed and approved by the City on a case-by-case basis. For further reference of curb type locations throughout the site and typical curb details, see Figure 8.43.

8.5.2 Paving

Paving will be a key component that defines the character, connectivity, and identity of Mission Rock's varied streets and open spaces. See Figures 8.44, 8.45, and 8.46 for proposed paving by street and zone. All paving in areas with high pedestrian traffic will facilitate universal accessibility. Paving connections to surrounding streets should be carefully considered for their impact on the larger Mission Bay neighborhood. Final pavement design for the roadway sections will be designed for the anticipated traffic load and equivalent single axial loads (ESAL) for a design life coordinated with the Acquiring Agency per the terms of the DA, DDA, and ICA.

The Pedestrian Throughway defined on each street shall be an accessible path of travel that is unobstructed by non-ADA-compliant paving or material treatments. Paving and built-in site elements shall be comprised of high-quality materials and finishes that are durable to withstand high-intensity use in the Bay environment. All material textures in designated clear path of travel and accessible use areas shall be ADA-compliant.

Where trees are planted in paving, surfacing material shall allow air and water to reach tree roots. Tree grates or stabilized crushed stone are permitted in the Streetlife Zone and in Open Spaces outside of dedicated Pedestrian Throughways. Where trees are planted in planting areas on streets, finish grade shall be within 2" of adjacent pedestrian paving.

8.5.3 Street Trees

Planting at Mission Rock will function ecologically to help achieve the Project's goals for sustainability and contribute to a healthy environment. Composition and distribution of a diverse, adapted urban forest, stormwater gardens, and planted areas will create a resilient ecological framework to shape varied sensory experiences across the site and provide waterfront and urban habitat. See Figures 8.47, 8.48, and 8.49.

Trees will be used to block and mitigate wind, provide shade and reduce urban heat island effect, and to provide shelter for birds. Native or climate appropriate grasses, shrubs, and ground cover will provide as much species diversity as feasible in Mission Rock's planting areas, as well as function in stormwater treatment gardens. Upon construction, maintenance and management of tree and understory planting, soils, and irrigation will be essential to the successful function of the site's urban ecological systems.

Tree species shall be considered for their aesthetic and ecological benefits. Suggested species diversity in Figure 8.48 is a baseline; species selected for specific areas shall conform to this general distribution and diversity for the Mission Rock urban forest. Tree species suggested for each component of the Public Realm network have been selected in consultation with a certified arborist. If alternative species are chosen, they shall conform to the aesthetic and performance requirements outlined in Figure 8.48.

8.5.3.1 Wind Mitigation

Tree selection and maintenance will be vital to maintaining a comfortable public realm experience in both streets and open spaces. Trees shall be sited with consideration given to wind modeling at the neighborhood and local scale. Mandatory wind tolerances have been noted under the design criteria for tree species selection.

8.5.3.2 Tree Species Installation and Establishment

Trees shall receive adequate soil volume to sustain long-term health. Trees shall receive adequate irrigation and monitoring during a three-year establishment period. Large and medium-size trees shall be installed at a minimum size of 48-inch-box; small trees shall be installed at a minimum size of 36-inch box. Refer to Figure 8.48 for tree size and corresponding minimum size at installation. To meet functional requirements in both streets and open spaces, clear trunk requirements shall be achieved within five years of installation. Branches shall not interfere with pedestrian throughway (minimum 84 inches of clearance measured from ground surface) or mandated fire truck vertical clearance of 13.5-inches-minimum (measured from roadway surface). Master Developer and/or HOA intends to enter into a street tree maintenance and management agreement with Public Works to address street tree maintenance.

8.5.3.3 Tree Maintenance and Management

Trees in the Public Realm should be pruned yearly to sustain long-term health and to maintain desired growth habit. Determine appropriate water application after establishment (three years) in consultation with a certified arborist's comprehensive review of tree health on the site. Monitor water application yearly.

8.5.3.4 Recommended Soil Volume for Trees

Trees in the public realm should have adequate soil volume and infiltration, particularly trees planted in paving. Large tree species require 1500-2000 cubic feet of soil volume per tree; Medium tree species require 1000-1500 cubic feet of soil per tree; Small tree species require 800-1000 cubic feet of soil per tree. Tree species sizes are noted in Figure 8.48.

8.5.3.5 Minimum clearance at On-Structure Conditions

Where trees are planted in on-structure conditions, at least 4-feet of soil depth, and a continuous gravel drainage layer that is 6-12 inches in depth, should be maintained.

8.5.4 Sustainable Water Strategies

Mission Rock's landscapes and building systems will work together and be designed to conserve, re-use, and filter water. Site hydrology will be intertwined with daily life at Mission Rock in a unique and systematic way, with stormwater treatment gardens that are a part of the public realm experience in every streetscape and open space, building-integrated recycled water systems, and advanced greywater reuse strategies. Irrigation is an essential element of plant health and should be considered as part of the site hydrology strategy.

8.5.4.1 Stormwater Treatment

Stormwater treatment will be handled through a combination of treatment within specific streets, and in centralized, large feature stormwater gardens to which runoff is conveyed by gravity or force main for treatment. See Figures 8.50 and 8.51 for a conceptual diagram of the site stormwater treatment approach, and refer to Section 16 for detailed discussion and analysis of stormwater management.

8.5.4.2 Irrigation

All plant species shall receive establishment irrigation for a minimum of two years. Tree species shall receive establishment irrigation for three years or as deemed necessary for long-term health by a certified arborist. Refer to Mission Rock Sustainability Strategy for guidance about water usage. Planting design shall optimize irrigation efficacy by grouping plants with similar water needs into efficient irrigation hydrozones. Permanent irrigation infrastructure shall be provided for all trees, understory planting, stormwater treatment gardens, and lawn areas. Irrigation flow meters for all irrigation hydrozones will be installed to record and monitor water use across the site, and watering records kept for all site trees, with a yearly water audit to track the amount of water applied.

Efficient irrigation systems will be utilized, with drip irrigation except in lawn areas, where spray irrigation is acceptable. Refer to Local Model Water Efficient Landscape Ordinance for regulatory guidance. Recycled water shall be used for irrigation, with potable backup,

to minimize potable water use. This use shall conform to applicable public health standards; edible plants and play areas shall not be irrigated with non-potable water. See Sustainability Strategy for recycled water resources and minimum water quality treatment thresholds.

8.5.5 Lighting

Lighting will be an important component of nighttime identity, experience, and safety at Mission Rock. Lighting of special, unique character should reinforce key pedestrian routes along the Shared Public Way and Channel Lane and Channel Street. Where possible, a variety of lighting types should work together to create a warm, inviting, and safe nighttime environment. See Figures 8.42-8.53.

Lighting across the site will be scaled to the pedestrian and bicycle experience and will reinforce key pedestrian circulation routes and connections. Lighting strategies will also take care to protect site residents by minimizing light pollution. Lighting along the waterfront will operate on a gradient of intensity from a well-lit Promenade at the Buildings and Piers to a more uniformly diffused, minimal character along the water that will not disrupt the ecology of the Bay edge. Lighting strategies shall minimize glare, light trespass outside the development, and light pollution in areas adjacent to residential buildings and along the waterfront. Refer to Section 7.6 of the Design Controls and to the Sustainability Strategy for vertical development lighting controls. Site lighting will comply with applicable regulatory standards.

Lighting fixtures and bulbs shall meet or exceed applicable energy-efficiency standards. Lighting shall be designed to allow facial recognition along paths of travel. Lighting shall not create glare or "hot spots" that would inhibit visual acuity, or unnecessary vertical transmittance of light. Lighting strategies shall facilitate sight lines and perception of safety across the public realm. Lighting uniformity ranges in open spaces shall allow for variation in light levels to create hierarchy and a range of experiences.

8.5.6 Accessible Loading

Loading zones for vehicular and paratransit loading and unloading will be distributed across the site to enable access to all Development Parcels and open spaces, with priority given to significant

pedestrian connections noted in Figure 8.15. Proposed configurations for loading stalls are described for the following conditions:

DPW-Standard Curb, 6-inches typical: Figure 8.54.

Non-DPW-Standard flush curb, Shared Public Way: Figure 8.56

Non-DPW-Standard flush curb, Terry A Francois Boulevard: Figure 8.55.

8.5.7 Driveway and Streetscape Coordination

The project will ensure that locations of above-grade utility boxes, where provided, are coordinated with streetscape elements. These locations shall be coordinated with tree spacing to ensure Urban Forestry standards are applied to the greatest extent possible. If provided at all Development Parcels except Block D, driveways shall be located only Exposition or Long Bridge Streets. Driveways for Block D shall be provided on Long Bridge, Bridgeview, and Mission Rock Streets. Driveways are not permitted on the Shared Public Way, Terry A Francois Boulevard, 3rd Street, or Bridgeview Street north of Long Bridge Street. Driveway locations shall be coordinated with placement of streetscape elements per Figure 8.57.

8.6 Traffic Calming

As part of the pedestrian and bicycle focused development plan outlined in the Mission Rock Transportation Plan, traffic calming elements are proposed to improve non-vehicular traffic safety and access. Proposed traffic calming elements for the Project street rights-of-way are identified in Figure 8.58 and include raised intersections, raised crosswalks, bulb-outs, and narrowed lane widths to accommodate bicycle infrastructure.

8.6.1 Raised Intersections and Raised Crosswalks

Raised intersections are proposed along the Shared Public Way, Terry A Francois Boulevard, and Bridgeview Street and are described in greater detail in Section 8.8. A raised mid-block pedestrian crosswalk is proposed along Bridgeview Street adjacent to Mission Rock Square and Channel Lane. A City Standard driveway is also proposed on Terry Francois Boulevard at the Mission Rock Street intersection to provide additional traffic calming measures as vehicles enter Terry A Francois Boulevard. At raised crosswalk and intersection locations, the street pavement areas will be raised as much as 6-inches to match the adjacent curb heights and will change paving material for a more effective visual cue to motorists. Final grades are dependent on overland release feasibility studies.

Where raised intersections or crossings are proposed, decorative crosswalk treatments or striped continental crosswalks shall be provided and comply with City and MUTCD standards and required review. Proposed decorative treatments shall meet ADA standards for slip-resistance. The design for these intersections and crosswalks will be coordinated with and are subject to the approval of the SFPUC, SFDPW, the SFMTA, and the San Francisco Fire Department (SFFD). Refer to Section 7: Site Grading for additional information about Project grading and overland release requirements. A typical raised crossing detail is shown on Figure 8.59.

The Developer or HOA will be responsible for maintenance and restoration of the street pavement sections, including pavement markings, within the raised intersection and raised crosswalk. Designs will incorporate measures to minimize maintenance and reduce the potential for dirt, silt and other debris to settle within the crosswalks.

8.6.2 Intersection Bulb-Outs

Bulb-outs have been strategically added along Long Bridge Street at the Shared Public Way intersection and along 3rd Street between Exposition Street and China Basin Park. These locations are expected to have a high concentration of pedestrian traffic traveling between the parking garage at Block D, the amenities along Shared Public Way, residential housing on the west side of 3rd Street, China Basin Park and AT&T Park just north of the development site. Bulb-outs will narrow driving lanes, create a shorter pedestrian crossing, make pedestrians more visible to motorists and require vehicles to reduce speeds. The final design for the bulb-outs will be coordinated with the SFMTA, SFDPW, SFPUC, and the SFFD. Bulb-out improvements will be constructed if the designs can meet the Acquiring Agency's requirements for overland drainage release, utility clearances, and accessibility for persons with disabilities. Overland Release at these locations will be studied in the Grading and Drainage Master Plan. A typical bulb-out detail is shown on Figure 8.59.

8.7 Off-Site Traffic Signalization

As shown in Figure 8.60 and described below, the Developer will be responsible for design and construction funding, either as partial contribution or in full, of traffic signal modifications or new traffic signals, as well as striping. Where possible, the electrical service for traffic signals will be located within the joint trench (see Section 17). Traffic signals shall be designed by and constructed to the specifications

of the SFMTA and SFDPW. If determined feasible, planned off-site intersection improvements include, but may not be limited to the following:

8.7.1 3rd Street and Existing Terry A Francois Boulevard

The existing traffic signal infrastructure at Terry A Francois Boulevard and 3rd Street will be removed or modified during the demolition of the northern segment of Terry A Francois Boulevard that currently provides east-west access across the site. The new intersection at this location will serve northbound and southbound vehicular and bike traffic as well as eastbound and westbound bike and pedestrian traffic. An updated signalized intersection is anticipated to provide safe crossing for bikes and pedestrians across 3rd Street. The developer will be responsible for SFMTA costs to review, design, coordinate and implement improvements including signal design and signal timing changes.

8.7.2 3rd Street and Channel Street

To accommodate improvements at the existing 3rd Street and Channel Street intersection, signal timing and phasing will be revised. Vehicular access on Channel Street will now terminate at 3rd Street and will no longer continue eastward onto the site. The left turn from southbound 3rd street and phasing segments will be removed from the signalization at the intersection. The developer will be responsible for SFMTA costs to review, design, coordinate and implement improvements including signal design and signal timing changes.

8.7.3 3rd Street and Mission Rock Street

The existing traffic signals at the 3rd Street and Mission Rock Street intersection are planned to remain in place. Restriping of the Mission Rock lanes will likely require phasing and timing design alterations for the intersection. Revisions to the existing signalization at 3rd Street and Mission Rock Street will be completed by the SFMTA.

8.7.4 3rd Street and Exposition Street

A new traffic signal will be installed at the intersection of 3rd Street and Exposition Street to provide safe mobility for vehicular traffic, cyclists and pedestrians. Vehicles exiting the site from Exposition Street will be permitted to turn right and left onto 3rd Street. Northbound vehicles on 3rd Street will be allowed right turn access into the site at Expositions Street. Left turns from southbound 3rd Street on to Exposition Street will be permitted. Pedestrian crosswalks will also be incorporated

across Exposition Street in the north-south and east-west directions. The developer will be responsible for SFMTA costs to review, design, coordinate and implement improvements.

8.7.5 4th Street Intersection Improvements

As described in the project DEIR, the Developer will provide funding to the SFMTA, for a maximum amount of one-million dollars to SFMTA to design and construct traffic signals at the intersections of 4th Street and Mission Rock Street and 4th Street and Long Bridge Street. Funding shall be provided prior to the issuance of approval for the third building site permit, but in no event later than the site permit for Block D2 parking garage, SFMTA will construct the improvements in advance of the Developer's proposed date of opening for the Block D2 parking garage.

8.7.6 Mission Rock Street Striping

As described in the project DEIR, the Developer will provide the following:

- Stripe a "keep clear" zone in front of the easternmost driveway closest to Bridgeview Street.
- Extend the southbound left-turn lane at the Third Street-Mission Rock Street intersection to a total length of 350-ft. In combination with the re-striped left-turn lane, install advance traffic signal detention equipment in coordination with SFMTA.
- Stripe a "keep clear" zone on Mission Rock Street adjacent to the driveway access points serving the public services building. Final location and extents of the "keep clear" zone will be coordinated with the SFFD and San Francisco Police Department during the construction document approval process.

8.8 On-Site Traffic Controls

Traffic calming and stop-controlled intersections, rather than signalization, are the primary strategy for on-site traffic control. Stop signs will be added at most of the intersections, with final locations to be determined by traffic sight distance requirements, Project phasing and coordination with the City. If implemented, stop signs on city streets will require legislation from SFMTA Board and traffic calming may also require SFMTA Board and/or public hearing.

8.8.1 All-Way Stop-Controlled Intersections: DPW-Standard Curb Condition

Mission Rock will have two all-way stop-controlled intersections at streets with DPW-Standard curbs, at the intersection of Bridgeview Street with Exposition Street (Figure 8.63) and the intersection of Bridgeview Street with Mission Rock Street (Figure 8.67). Bicycle and vehicular traffic will stop in all directions at these intersections. Crosswalks will be marked with City-

standard markings, and DPW-Standard curb ramps will be provided at crosswalks. Bicycle facility treatment will continue across these intersections for all streets. Refer to Transportation Plan for traffic volume information at these intersections.

8.8.2 All-Way Stop-Controlled Intersections: Raised Intersections

Mission Rock will have two all-way stop-controlled intersections that are also raised intersections. These occur at the intersection of the Shared Public Way with Long Bridge Street and at Exposition Street. The Shared Public Way will have one-way northbound traffic only, from Long Bridge Street to Exposition Street. Refer to Transportation Plan for traffic volume information at these intersections.

8.8.2.1 Shared Public Way at Long Bridge Street

At the intersection of the Shared Public Way with Long Bridge Street, vehicular and bicycle traffic on Long Bridge Street will stop in both directions; Long Bridge Street traffic is permitted to turn onto the Shared Public Way at this intersection, but turning will be discouraged through design cues. Refer to Section 8.4.2 and Figure 8.64.

8.8.2.2 Shared Public Way at Exposition Street

At the intersection of the Shared Public Way with Exposition Street, vehicular and bicycle traffic on Exposition Street will stop in both directions and no turns will be permitted. Shared Public Way traffic will stop at the intersection with Exposition Street, and is permitted to turn right or left. The Shared Public Way becomes a paseo north of this intersection; vehicular traffic will not be permitted on the paseo, but it will accommodate emergency vehicle access for up to 150-feet of its length per Section 8.4. Approved removable or hydraulic bollards will be installed at Exposition Street to prohibit vehicular entry.

8.8.3 2-Way Stop at Raised Intersection

Mission Rock will have one internal two-way stop-controlled intersection, at the intersection of Bridgeview Street with Long Bridge Street (Figure 8.65). Vehicular and bicycle traffic on Long Bridge Street will stop in both directions, while bicycle and vehicular traffic on Bridgeview Street will continue through without stopping. This intersection will be raised to meet the grade of the raised cycle track. Crosswalks will be marked with City- standard markings, and DPW-Standard

curb ramps will be provided at crosswalks. Bicycle facility treatment on Bridgeview Street will continue across this intersection. Refer to Transportation Plan for traffic volume information at these intersections.

8.8.4 All-Way Stop-Controlled Intersections: Flush Intersections

Mission Rock will have two all-way stop-controlled intersections that are also flush intersections, at the intersection of Terry A Francois Boulevard with Long Bridge Street and at Exposition Street. Grade transition will occur within the Terry A Francois Boulevard ROW. Terry A Francois Boulevard will have two-way traffic.

8.8.4.1 Terry A Francois Boulevard at Exposition Street (Figure 8.66).

At the intersection of Terry A Francois Boulevard with Exposition Street, vehicular and bicycle traffic on Exposition Street will stop; Exposition Street terminates at Terry A Francois Boulevard. For all vehicles except trucks servicing Pier 48, right turns only will be permitted onto Terry A Francois Boulevard. Northbound Terry A Francois Boulevard traffic will stop at the intersection with Exposition Street, and is permitted to turn left only. Terry A Francois Boulevard becomes a paseo north of this intersection. The paseo will accommodate emergency vehicle access for up to 150-feet of its length. Approved removable or hydraulic bollards will be installed to restrict vehicular entry; vehicular traffic will be permitted only for passenger loading within a clearly delineated and signed area (refer to Section 8.4.3).

8.8.4.2 Terry A Francois Boulevard at Long Bridge Street.

At the intersection of Terry A Francois Boulevard with Long Bridge Street, vehicular and bicycle traffic on Long Bridge Street will stop; Long Bridge Street terminates at Terry A Francois Boulevard. Long Bridge Street traffic is permitted to turn onto Terry A Francois Boulevard in both directions at this intersection. Terry A Francois Boulevard traffic will stop at this intersection in both directions, and turning onto Long Bridge Street is permitted. This intersection will be coordinated with Pier 50 operational requirements.

8.9 Public Transportation System

The Mission Rock site is adjacent to the Muni light rail along King Street and 3rd Street and the Caltrain 4th and King station. It is nearby the Bay Area Rapid Transit (BART) stations for Embarcadero,

Montgomery and Powell Street. The Transbay Transit Center, currently under construction, within the Financial District is also within close proximity to the proposed development. To encourage the use of these and other modes of sustainable transportation, the Mission Rock development has prioritized pedestrian, bike and transit access through the site. Ride share programs are also promoted within the design by incorporating loading and drop off zones throughout the proposed public street network.

Although there are no anticipated bus or light rail improvements associated with this Project, it is the Project team's understanding that SFMTA plans on enhancing the existing Muni transit networks near the Mission Bay area to improve commuter connections and efficiency throughout San Francisco. These improvements will be under the responsibility of SFMTA. For additional information regarding the public transportation system, refer to the latest edition of the Project Transportation Plan.

8.10 SFMTA Infrastructure

Where required, the following list of infrastructure items includes items to be owned, operated and maintained by the SFMTA within public right-of-ways:

- Security monitors and cameras
- Signals and Signal Interconnects, including Muni Bus Prioritization signals
- TPS signal preempt detectors
- Conduit containing TPS signal cables
- Shelters (with Vendor)
- Paint – poles and asphalt delineating coach stops
- Asphalt painting for transit lanes
- Departure prediction ("NextBus") monitors and related communications equipment
- Bicycle racks
- Crosswalk striping, except for areas with a raised intersection/crosswalk or with painted concrete special striping or other special decorative treatment
- Bike lane and facility striping
- APS/Pedestrian crossing signals
- Street Signs

8.11 Acceptance and Maintenance of Street Improvements

Upon acceptance of the new and/or improved public streets, including the structures supporting the streets, by the Acquiring Agency, responsibility for the operation and maintenance of the roadway and streetscape elements will be designated to the appropriate Acquiring Agency as defined in the City of San Francisco Municipal Code and related ordinances, and the Project DA, DDA, ICA, or a separate MOU or MOA per the terms of the ICA. Conflicts between proposed public utility infrastructure and the surface improvements proposed as part of the Project, including but not limited to dedicated transportation routes, trees, bulb-outs, traffic circles and medians, shall be minimized in the design of the infrastructure and surface improvements. The Acquiring Agency responsible for said utility infrastructure will review all proposals for surface improvements above proposed public utility infrastructure on a case-by-case basis to ensure that future access for maintenance is preserved. Stormwater management and treatment infrastructure installed as part of the streetscape to meet the Stormwater Management Requirements and Design Guidelines (SMR) will be maintained by the Master Developer and/or Acquiring Agency subject to the terms of the Project DA, DDA, ICA, or a separate MOU or MOA per the terms of the ICA.

As outlined in the DA, DDA, ICA, or a separate MOU or MOA, the Master Developer or Port will be responsible for maintenance and restoration of the non-standard materials and design features, including decorative paving and hardscape elements, as well as specific streetscape elements and encroachments. Restoration will include replacement of the pavement markings within areas with non-standard materials.

8.12 Phasing of New Roadway Construction

New roadway construction will occur in phases based on the principle of adjacency and as-needed to facilitate a specific proposed Development Phase and consistent with the requirements of the Project Phasing Plan, and the DA, DDA, ICA, or a separate MOU or MOA. The amount and location of roadway repair/ or replacement will be the minimum necessary to support the Development Phase and maintain minimum required parking allocations, access and utility connections. Such phased roadway construction will allow the existing utility services, vehicular and pedestrian access areas, and landscaped spaces to remain in place as long as possible and reduce disruption of existing uses on the site and adjacent facilities.

Temporary Fire truck turnaround areas, if any, will be coordinated with the SFFD and constructed by the Developer consistent with the Fire Code. Phasing of traffic signalization improvements will be based on

cumulative development thresholds identified by the Project traffic consultant and/or the SFMTA coincident with the Phase applications, construction documents or as stated in the DA. Sidewalk and other accessible pedestrian paths of travel, either permanent or temporary, shall be provided to serve the pedestrian entrance and exit requirements of each Development Parcel prior to being released for occupancy. Such paths of travel will connect to the sidewalks along 3rd Street, Mission Rock Street and Terry A Francois Boulevard and hence to the public transit stations and bus stops thereon.

The Developer will be responsible for mitigating impacts to improvements installed with previous Project Development Phase(s) due to the designs or construction of current or future Development Phases, which will be addressed prior to approval of the construction drawings for the current or future Development Phase.

FIGURE 8.1: PUBLIC REALM PLAN

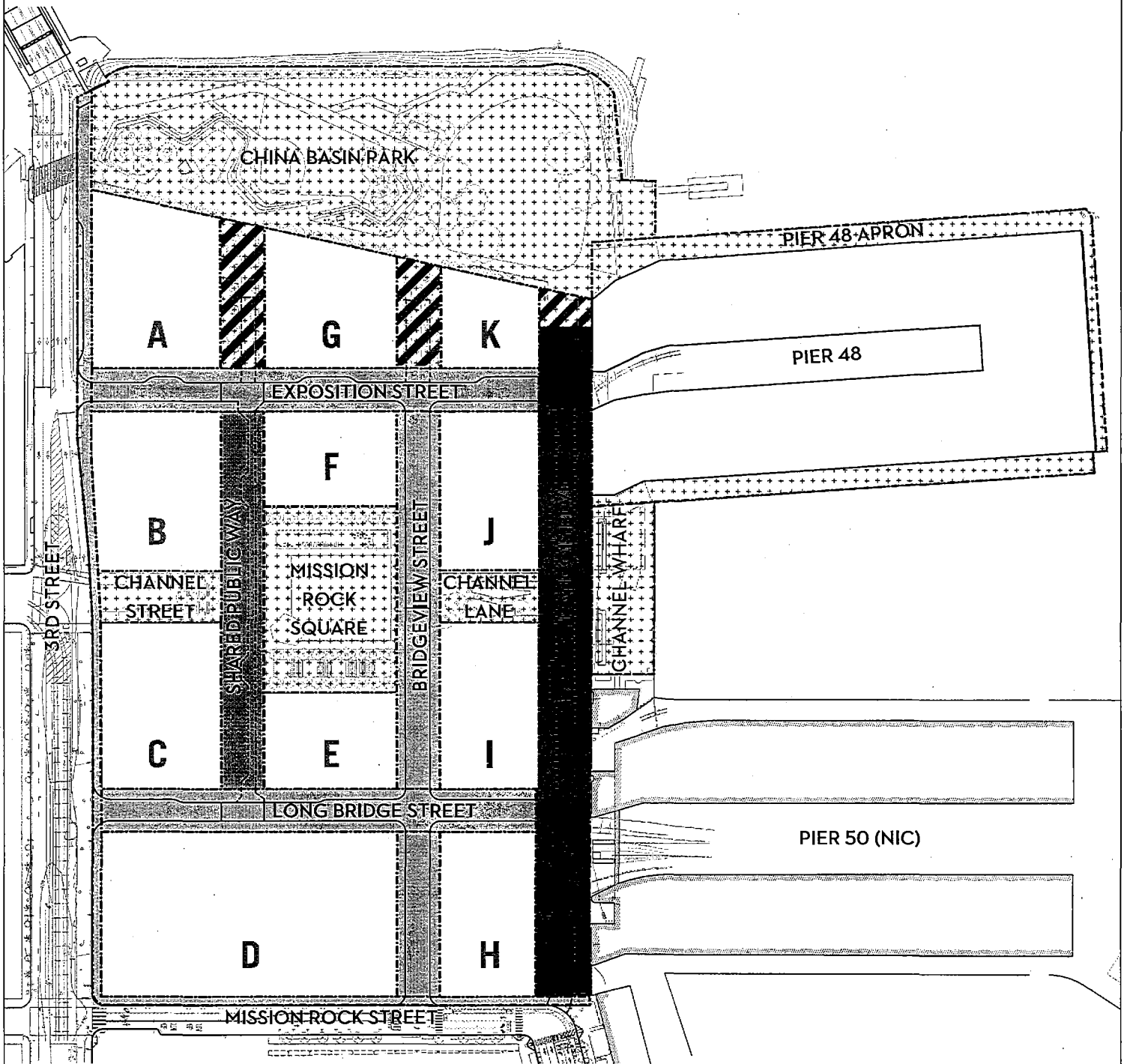



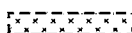
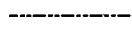

FIGURE 8.1: PUBLIC REALM PLAN



- | | |
|--|--|
| <p> Shared Public Way</p> <ul style="list-style-type: none"> - Pedestrian access permitted across entire ROW; vehicular traffic permitted in Shared Zone only - Traffic volumes anticipated not to exceed 100 cars per hour; one-way northbound traffic - Flush curb on both sides of vehicular zone <p> Working Waterfront (Terry A Francois Boulevard)</p> <ul style="list-style-type: none"> - Pedestrian access permitted across entire ROW; vehicular traffic permitted in Shared Zone only - Traffic volumes anticipated not to exceed 100 cars per hour; two-way traffic - Flush curb on both sides of vehicular zone | <p> Vehicular/Neighborhood Street</p> <ul style="list-style-type: none"> - Two-way street with curb-separated sidewalk - Must include bicycle facilities or sharrows - Loading and service access provided in dedicated areas <p> Paseo (Open Space within R.O.W.)</p> <ul style="list-style-type: none"> - Non-vehicular street connection; accommodates emergency vehicle access <p> Open Space (Shown for reference only)</p> <p> Proposed Boundary</p> |
|--|--|

Source: CMG LANDSCAPE ARCHITECTURE, 07/2016

DRAWING NAME: \\DKF-SF\vol14\2008\0800000\Mission Rock\ENR\Exhibits\Infrastructure Plan Exhibits\Plotted Sheets\Figure 8.2 Conceptual Site Plan & Street Layout.dwg
 PLOT DATE: 07-13-17 PLOTTED BY: FELI

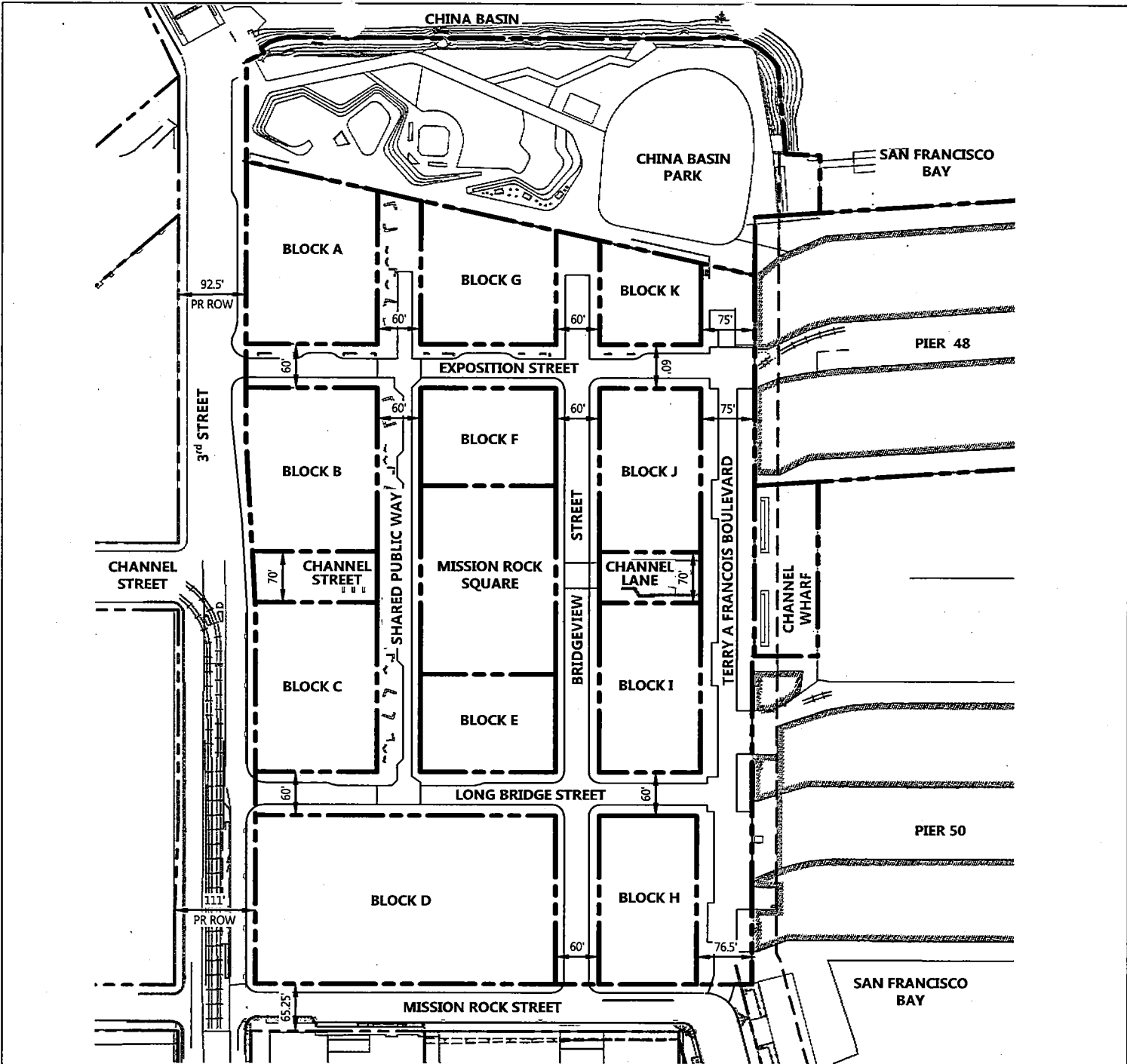

LEGEND

- PROPOSED PARCEL LINE
- EXISTING PARCEL LINE
- 60' RIGHT-OF-WAY DIMENSIONS

Source: BKF ENGINEERS, 07/2016



DRAWING NAME: \\BKF-SF\vol14\2008\080000\Mission Rock\ENG\Exhibits\Infrastructure Plan Exhibits\Plotted Sheets\Figure 8.3 Roadway Dimensions.dwg
 PLOT DATE: 07-13-17
 PLOTTED BY: FEL

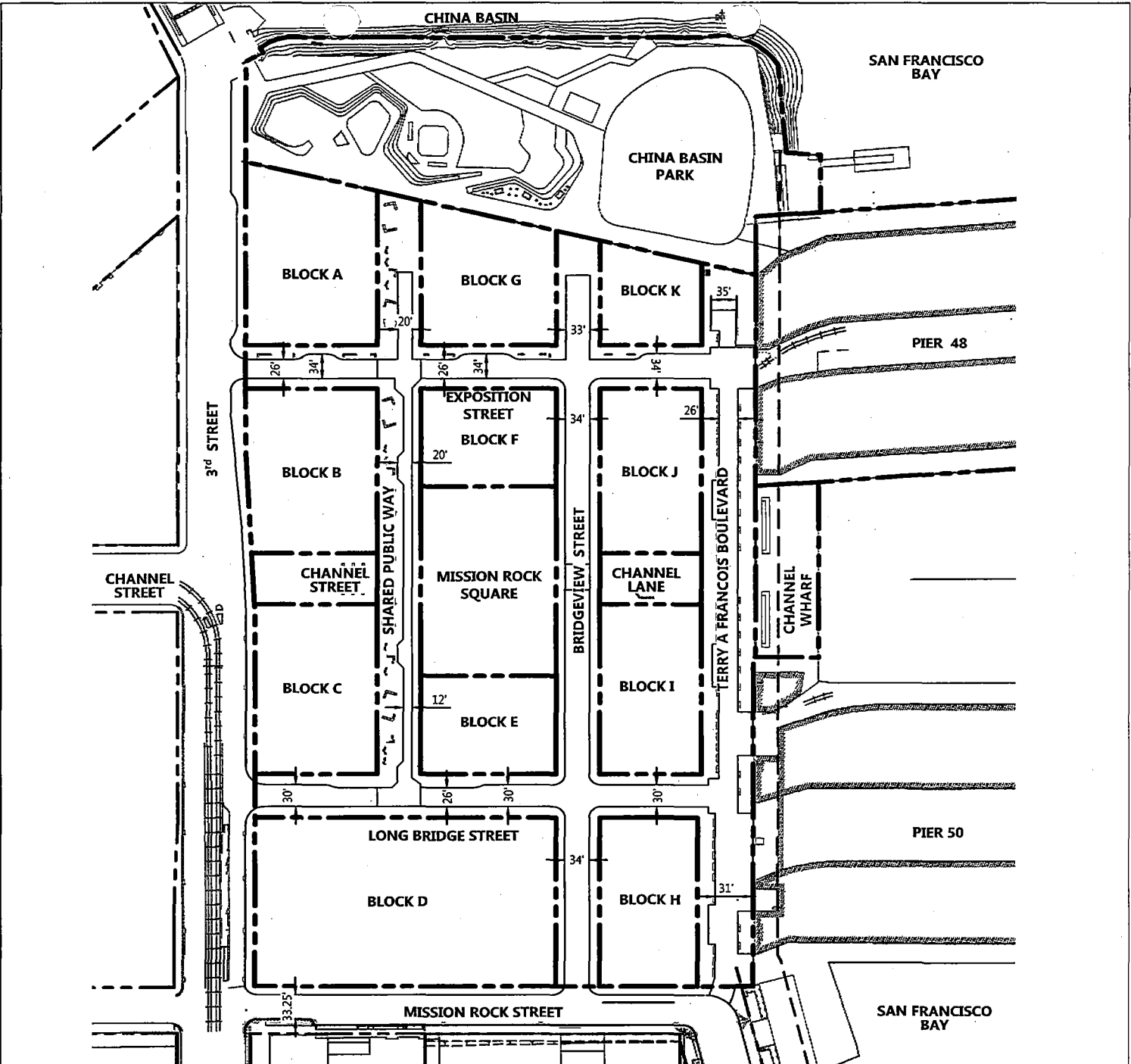

LEGEND
 - - - - - PROPOSED PARCEL LINE
 _____ EXISTING PARCEL LINE

Source: BKF ENGINEERS, 07/2018

DRAWING NAME: \\DWF-SF\Vol4\2008\000006_Mission Rock\ENG\Exhibits\Infrastructure_Plan_Exhibits\Plotted_Sheets\Figure 8.4 Plan View & Cross Section Locations.dwg
 PLOT DATE: 07-15-17
 PLOTTED BY: FELI

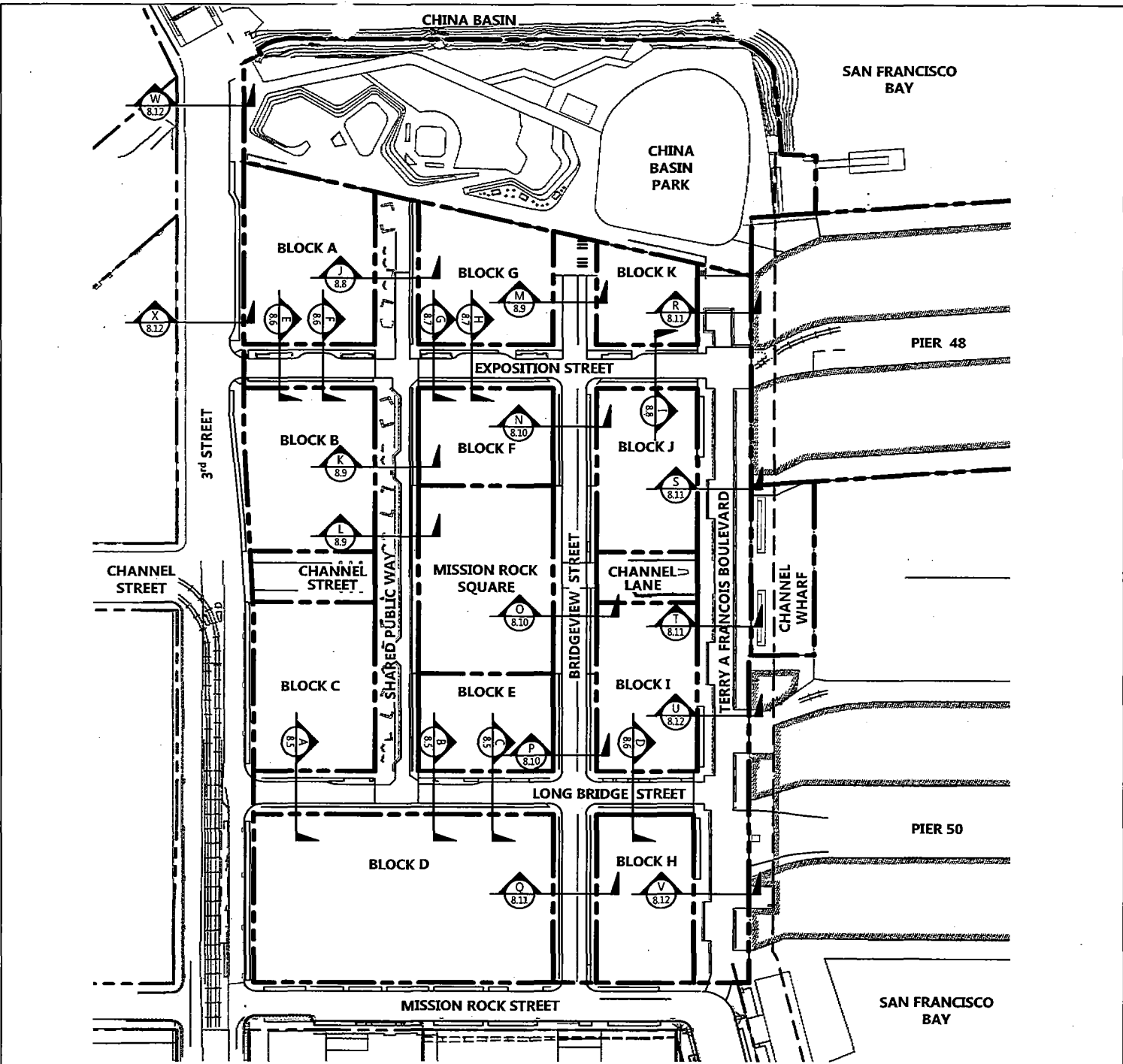

- LEGEND**
- PROPOSED PARCEL LINE
 - - - EXISTING PARCEL LINE
 - ⬆️ SECTION LOCATION

NOTES
 SEE FIGURES 8.5 - 8.12 FOR TYPICAL STREET CROSS SECTIONS.

Source: BNF ENGINEERS, 07/2016

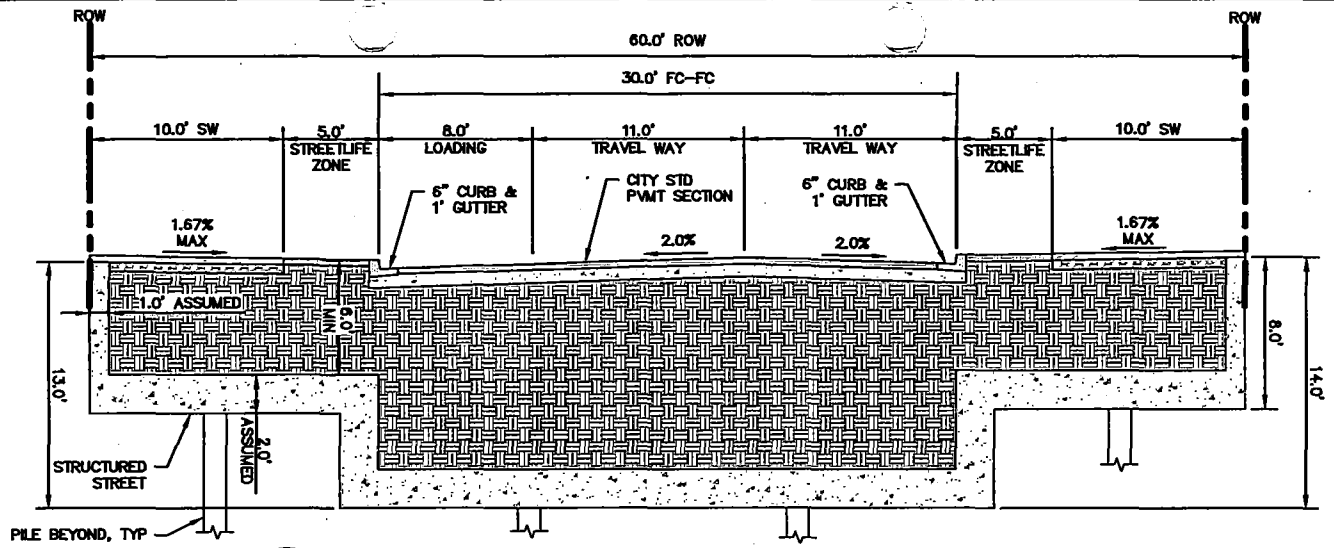

A

LONG BRIDGE STREET
NTS

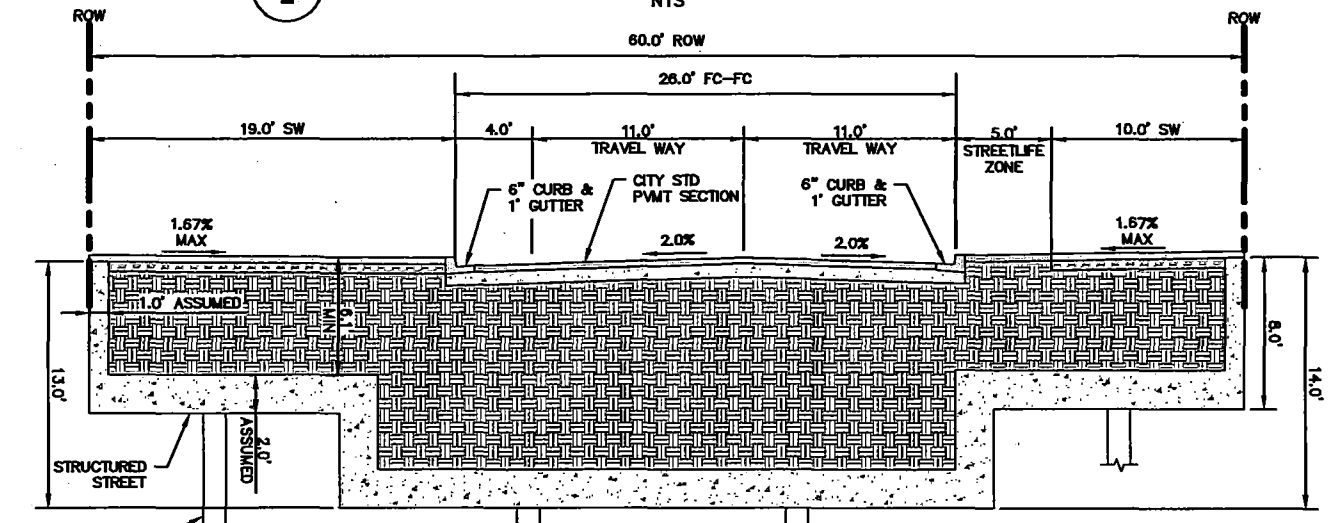

B

LONG BRIDGE STREET
NTS

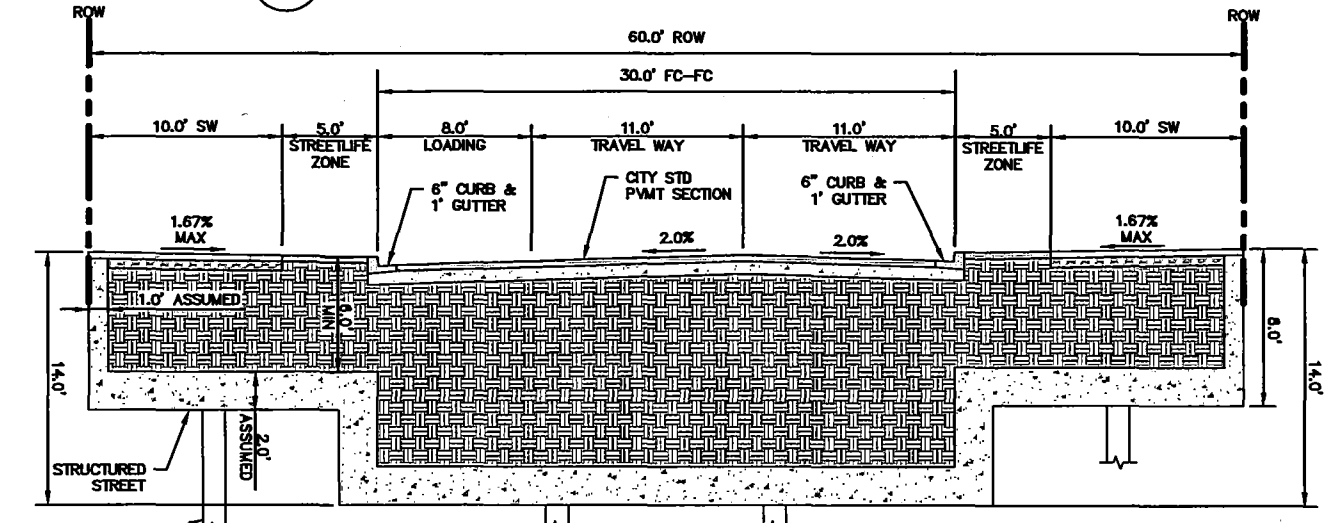

C

LONG BRIDGE STREET
NTS

LEGEND

AC	ASPHALT CONCRETE	ROW	RIGHT OF WAY
APPROX	APPROXIMATE	STD	STANDARD
BCDC	BAY CONSERVATION AND DEVELOPMENT COMMISSION	SW	SIDEWALK
EX	EXISTING	TYP	TYPICAL
FC	FACE OF CURB		
MIN	MINIMUM		
PCC	PORTLAND CONCRETE CEMENT		
PVMT	PAVEMENT		

NOTES

1. STREETLIFE ZONE MAY INCLUDE LANDSCAPE ELEMENTS, STREET LIGHT, BIORETENTION AREAS, AND PAVEMENT.
2. DIMENSION SHOWN ARE FROM FACE OF CURB TO FACE OF CURB.

DRAWING NAME: \\BKF-SF\vol\2008\080006_Mission Rock\ENG\Exhibits\Infrastructure Plan Exhibits\Plotted Sheets\Figure 8.5-8.12 Typical Street Cross Sections.dwg
PLOT DATE: 07-13-17
PLOT BY: FEL

Source: BKF ENGINEERS, 07/2016

DRAWING NAME: \\BKF-SF\vol14\2008\000000_Mission Rock\ENG\Exhibits\Infrastructure Plan Exhibits\Plotted Sheets\Figure 8.5-8.12 Typical Street Cross Sections.dwg
 PLOT DATE: 07-15-17
 PLOTTED BY: FELI

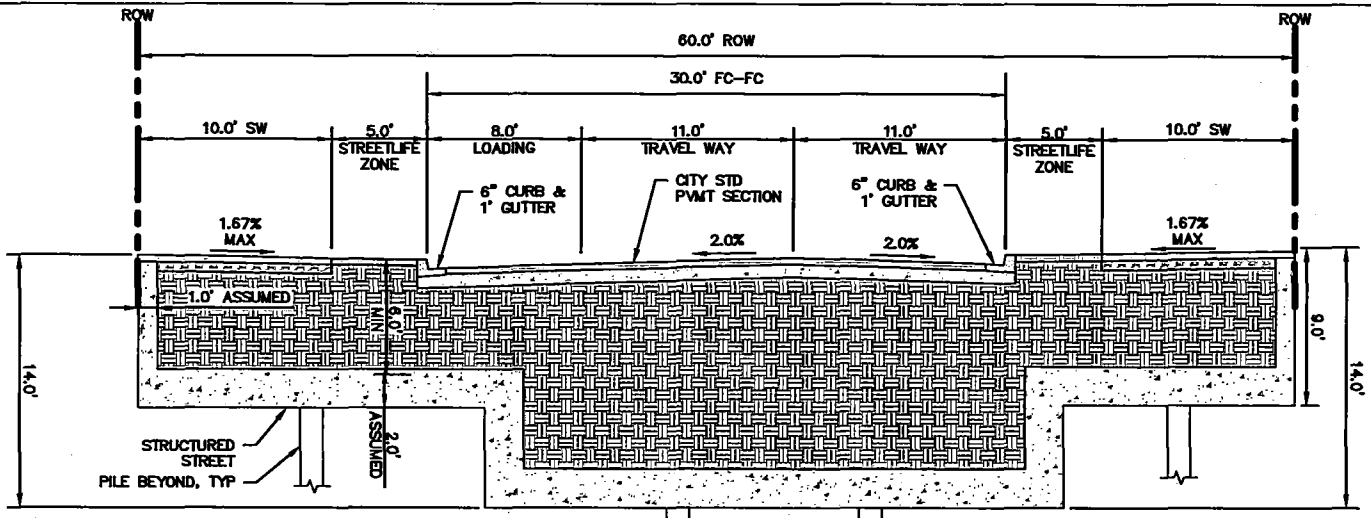

D

LONG BRIDGE STREET
NTS

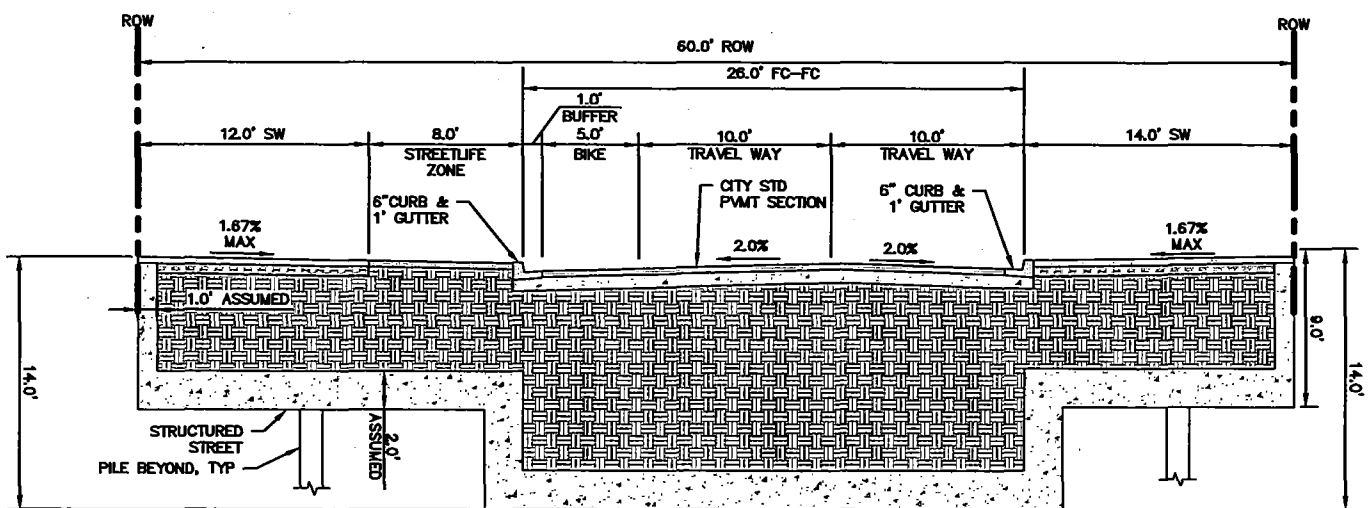

E

EXPOSITION STREET
NTS

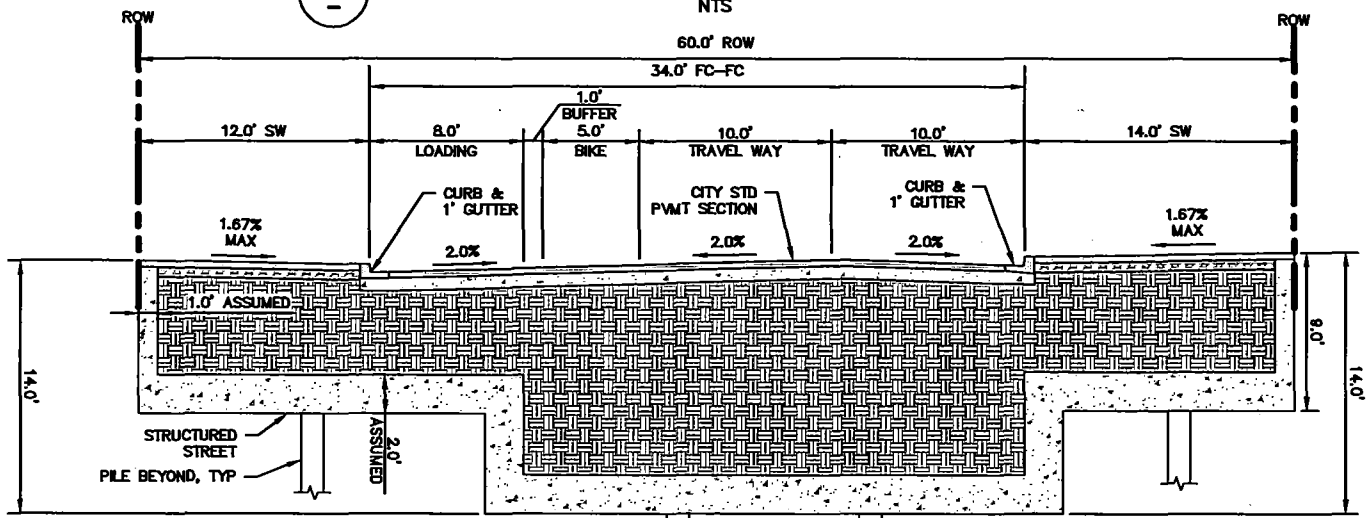

F

EXPOSITION STREET
NTS

LEGEND	
AC	ASPHALT CONCRETE
APPROX	APPROXIMATE
BCDC	BAY CONSERVATION AND DEVELOPMENT COMMISSION
EX	EXISTING
FC	FACE OF CURB
MIN	MINIMUM
PCC	PORTLAND CONCRETE CEMENT
PVMT	PAVEMENT
ROW	RIGHT OF WAY
STD	STANDARD
SW	SIDEWALK
TYP	TYPICAL

- NOTES**
- STREETLIFE ZONE MAY INCLUDE LANDSCAPE ELEMENTS, STREET LIGHT, BIORETENTION AREAS, AND PAVEMENT.
 - DIMENSION SHOWN ARE FROM FACE OF CURB TO FACE OF CURB.

DRAWING NAME: \\BKF-SF\voila\2008\0800000_Mission Rock\Exhibits\Infrastructure Plan Exhibits\Plotted Sheets\Figure 8.5-8.12 Typical Street Cross Sections.dwg
 PLOT DATE: 07-15-17
 PLOTTED BY: FEL

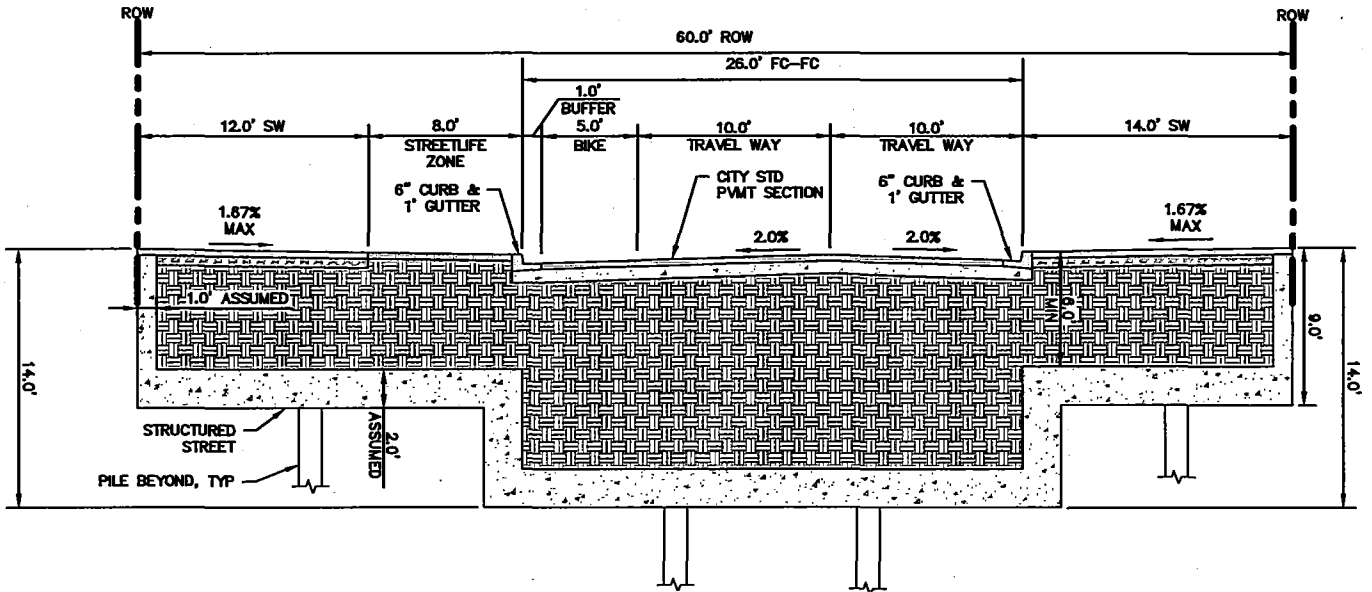

G

EXPOSITION STREET
NTS

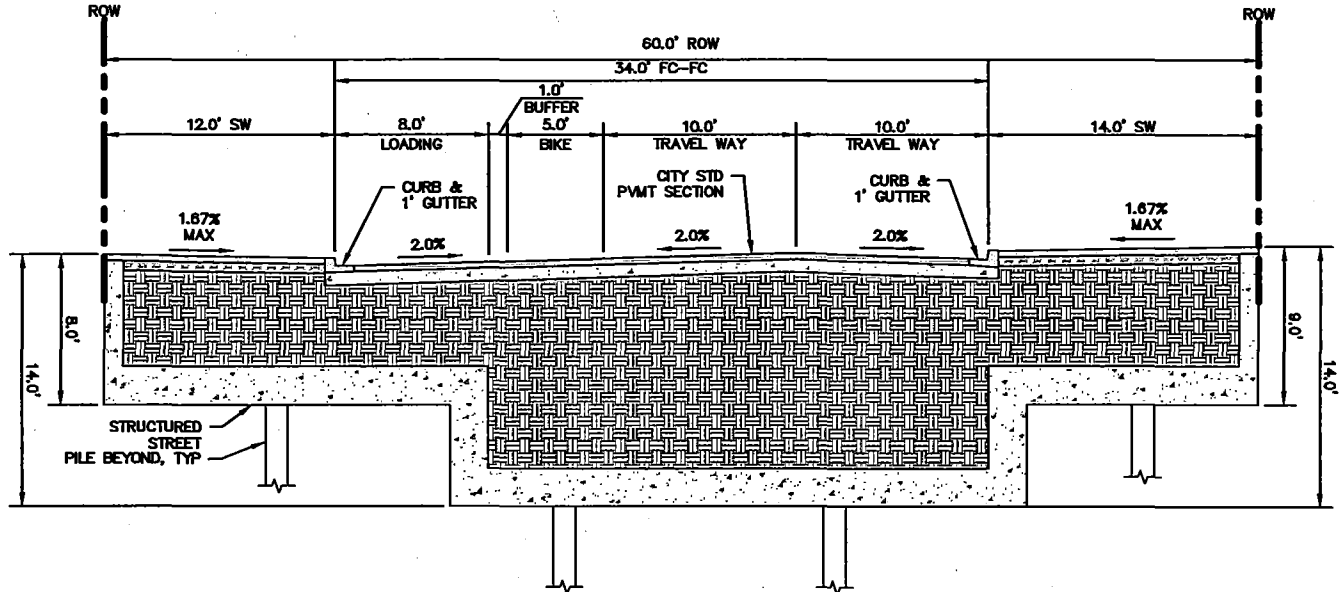

H

EXPOSITION STREET
NTS

LEGEND	
AC	ASPHALT CONCRETE
APPROX	APPROXIMATE
BCDC	BAY CONSERVATION AND DEVELOPMENT COMMISSION
EX	EXISTING
FC	FACE OF CURB
MIN	MINIMUM
PCC	PORTLAND CONCRETE CEMENT
PVMT	PAVEMENT
ROW	RIGHT OF WAY
STD	STANDARD
SW	SIDEWALK
TYP	TYPICAL

- NOTES**
- STREETLIFE ZONE MAY INCLUDE LANDSCAPE ELEMENTS, STREET LIGHT, BIORETENTION AREAS, AND PAVEMENT.
 - DIMENSION SHOWN ARE FROM FACE OF CURB TO FACE OF CURB.

DRAWING NAME: \\BKF-SF\vol1\2008\000006\Mission Rock\Exhibits\Infrastructure Plan Exhibits\Plotted Sheets\Figure 8.5-B.12 Typical Street Cross Sections.dwg
 PLOT DATE: 07-13-17
 PLOTTED BY: FELI

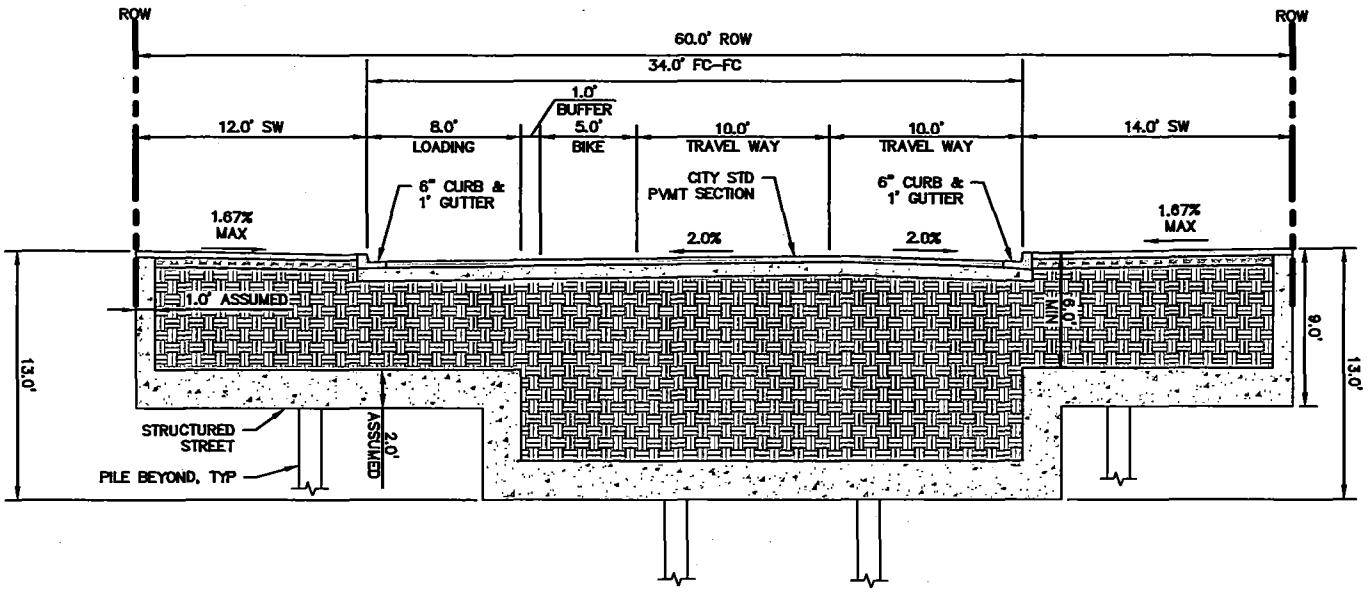

EXPOSITION STREET
NTS

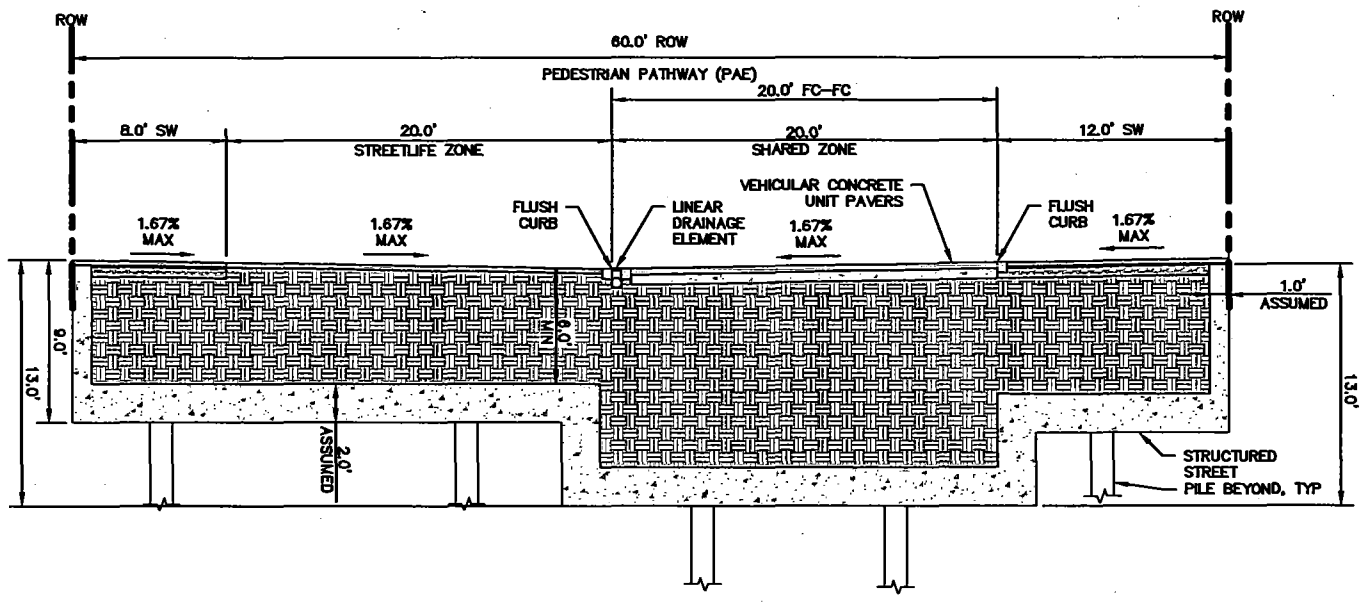

SHARED PUBLIC WAY
NTS

LEGEND	
AC	ASPHALT CONCRETE
APPROX	APPROXIMATE
BCDC	BAY CONSERVATION AND DEVELOPMENT COMMISSION
EX	EXISTING
FC	FACE OF CURB
MIN	MINIMUM
PCC	PORTLAND CONCRETE CEMENT
PVMT	PAVEMENT
ROW	RIGHT OF WAY
STD	STANDARD
SW	SIDEWALK
TYP	TYPICAL

- NOTES**
- STREETLIFE ZONE MAY INCLUDE LANDSCAPE ELEMENTS, STREET LIGHT, BIORETENTION AREAS, AND PAVEMENT.
 - DIMENSION SHOWN ARE FROM FACE OF CURB TO FACE OF CURB.

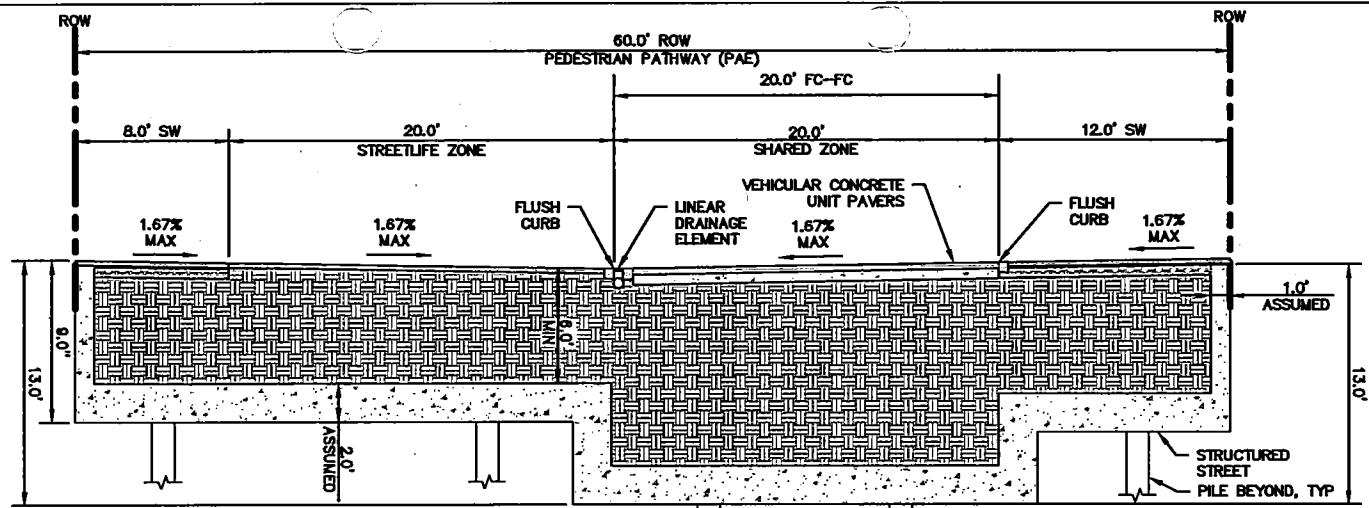

K

SHARED PUBLIC WAY

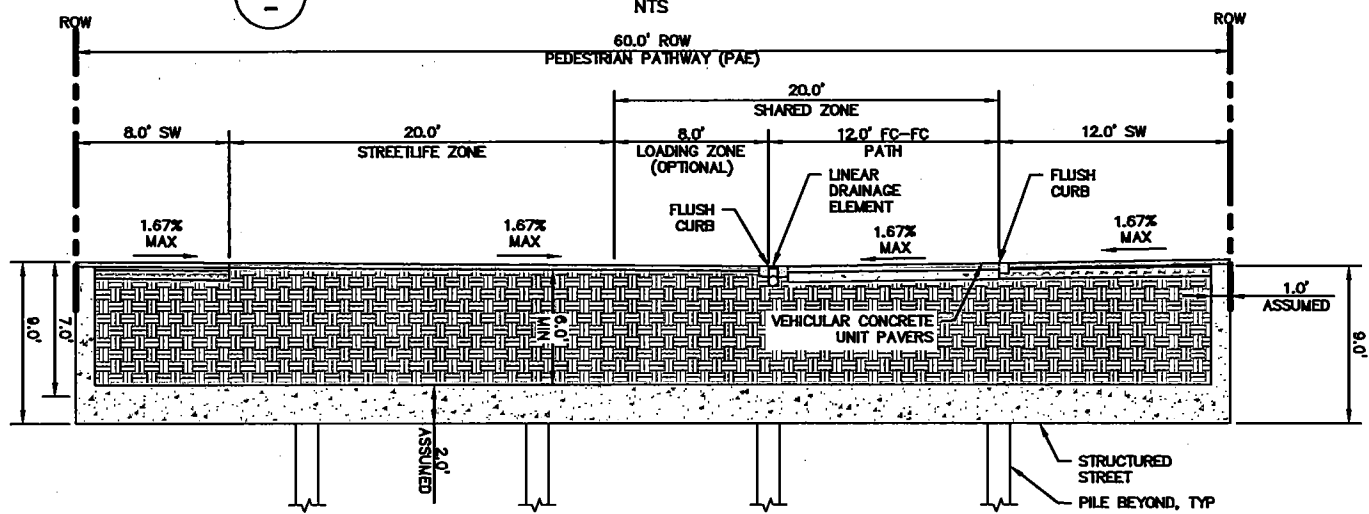

L

SHARED PUBLIC WAY

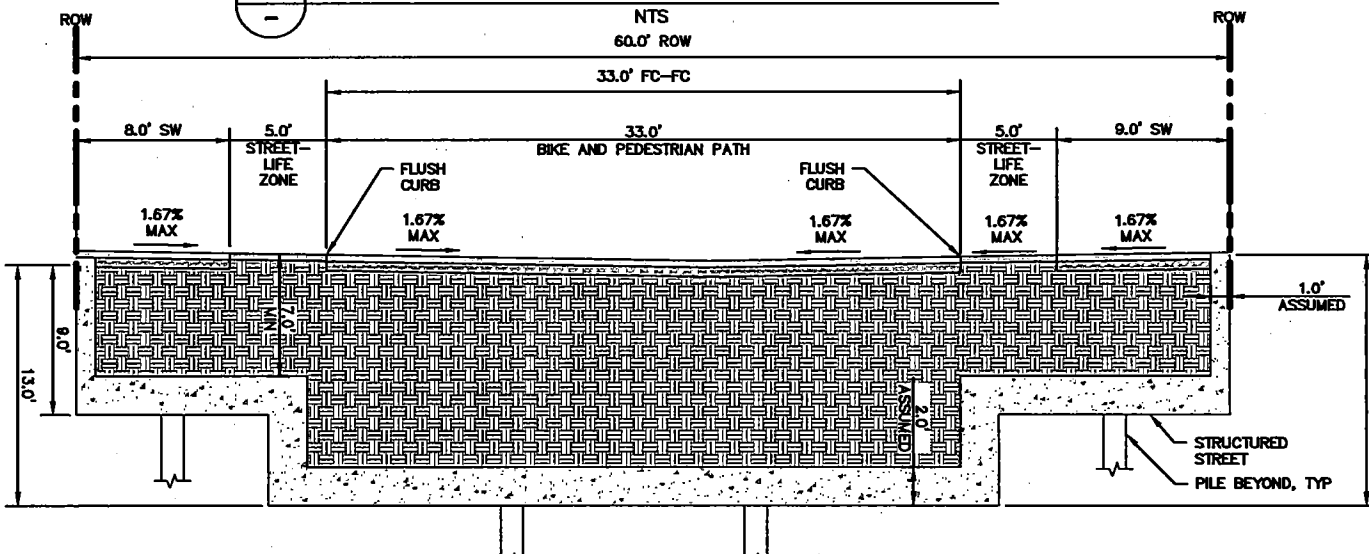

M

BRIDGEVIEW STREET

LEGEND

AC	ASPHALT CONCRETE	ROW	RIGHT OF WAY
APPROX	APPROXIMATE	STD	STANDARD
BCDC	BAY CONSERVATION AND DEVELOPMENT COMMISSION	SW	SIDEWALK
EX	EXISTING	TYP	TYPICAL
FC	FACE OF CURB		
MIN	MINIMUM		
PCC	PORTLAND CONCRETE CEMENT PAVEMENT		
PVMT			

NOTES

- STREETLIFE ZONE MAY INCLUDE LANDSCAPE ELEMENTS, STREET LIGHT, BIORETENTION AREAS, AND PAVEMENT.
- DIMENSION SHOWN ARE FROM FACE OF CURB TO FACE OF CURB.

Source: BKF ENGINEERS, 07/2016

DRAWING NAME: \\BKF-SF\vol\2008\080000_Mission_Rock\ENR\Exhibits\Infrastructure_Plan_Exhibits\Plotted_Sheets\Figure 8.5-8.12 Typical Street Cross Sections.dwg
PLOT DATE: 11-15-17
PLOTTED BY: volk

DRAWING NAME: \\014\2008\000006.Mission Rock\Exhibits\Infrastructure\Plotted Sheets\Figure 8.5-9.12 Typical Street Cross Sections.dwg
 PLOT DATE: 07-15-17
 PLOTTED BY: FELI

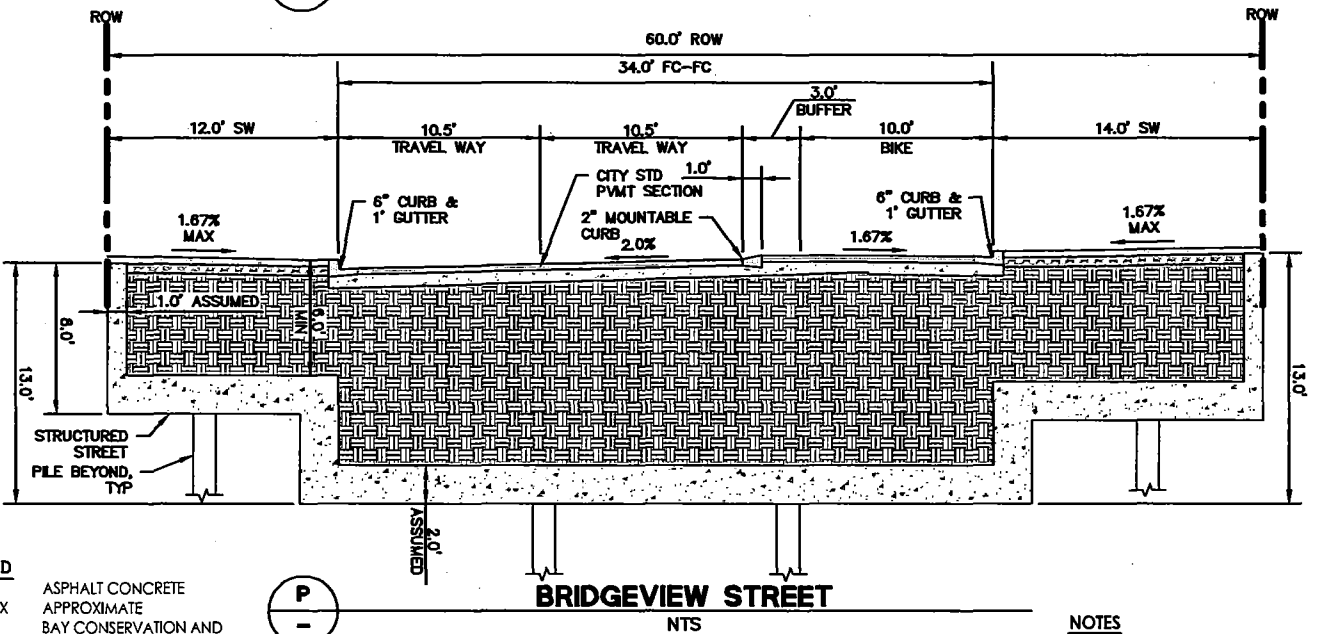
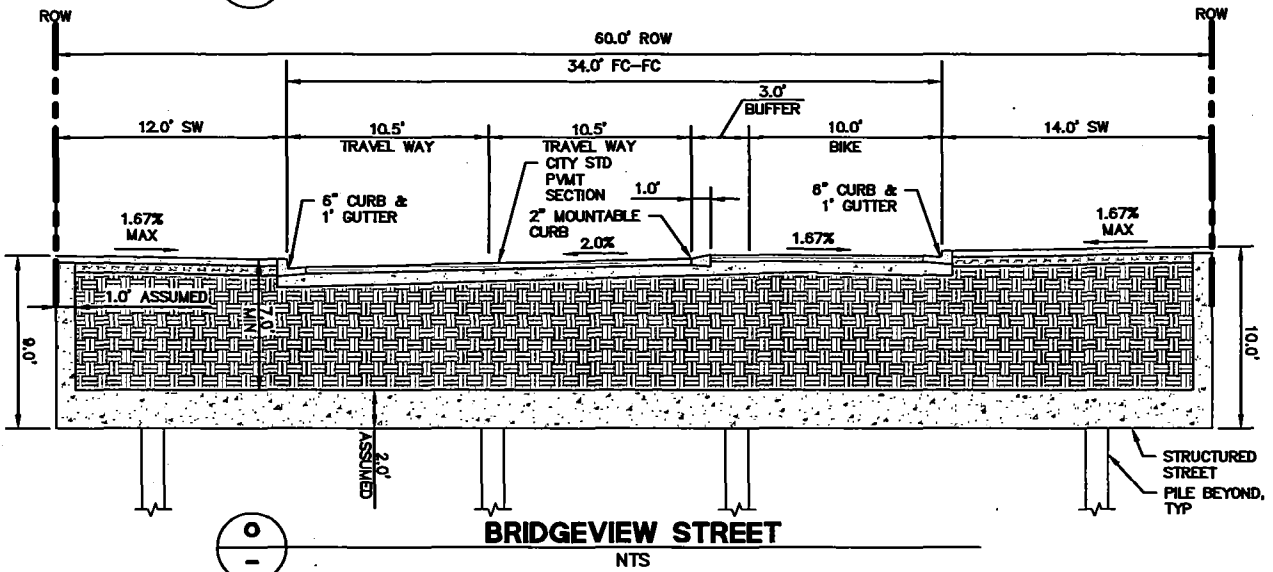
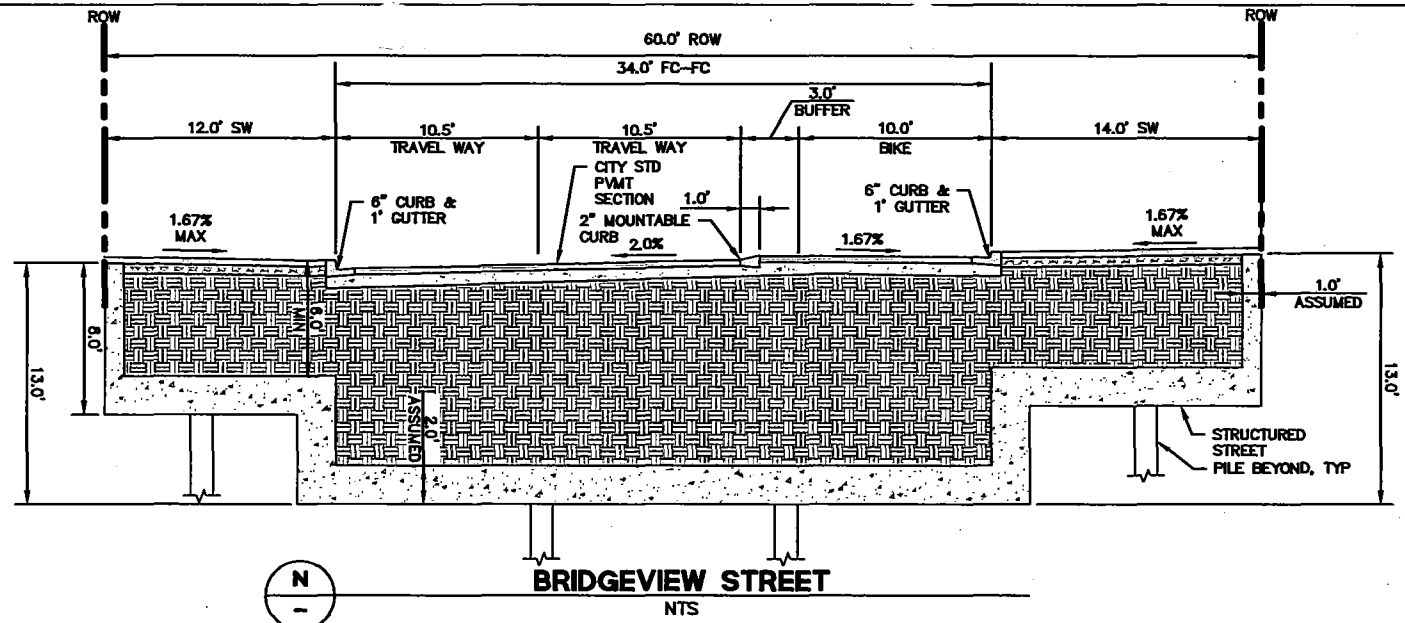

LEGEND	
AC	ASPHALT CONCRETE
APPROX	APPROXIMATE
BCDC	BAY CONSERVATION AND DEVELOPMENT COMMISSION
EX	EXISTING
FC	FACE OF CURB
MIN	MINIMUM
PCC	PORTLAND CONCRETE CEMENT
PVMT	PAVEMENT
ROW	RIGHT OF WAY
STD	STANDARD
SW	SIDEWALK
TYP	TYPICAL

- NOTES**
1. STREETLIFE ZONE MAY INCLUDE LANDSCAPE ELEMENTS, STREET LIGHT, BIORETENTION AREAS, AND PAVEMENT.
 2. DIMENSION SHOWN ARE FROM FACE OF CURB TO FACE OF CURB.

DRAWING NAME: \\BKF-SF\va\2008\080006\Mission Rock\ENG\Exhibits\Infrastructure Plan Exhibits\Plotted Sheets\Figure 8.5-8-12 Typical Street Cross Sections.dwg
 PLOT DATE: 07-15-17
 PLOTTED BY: FELI

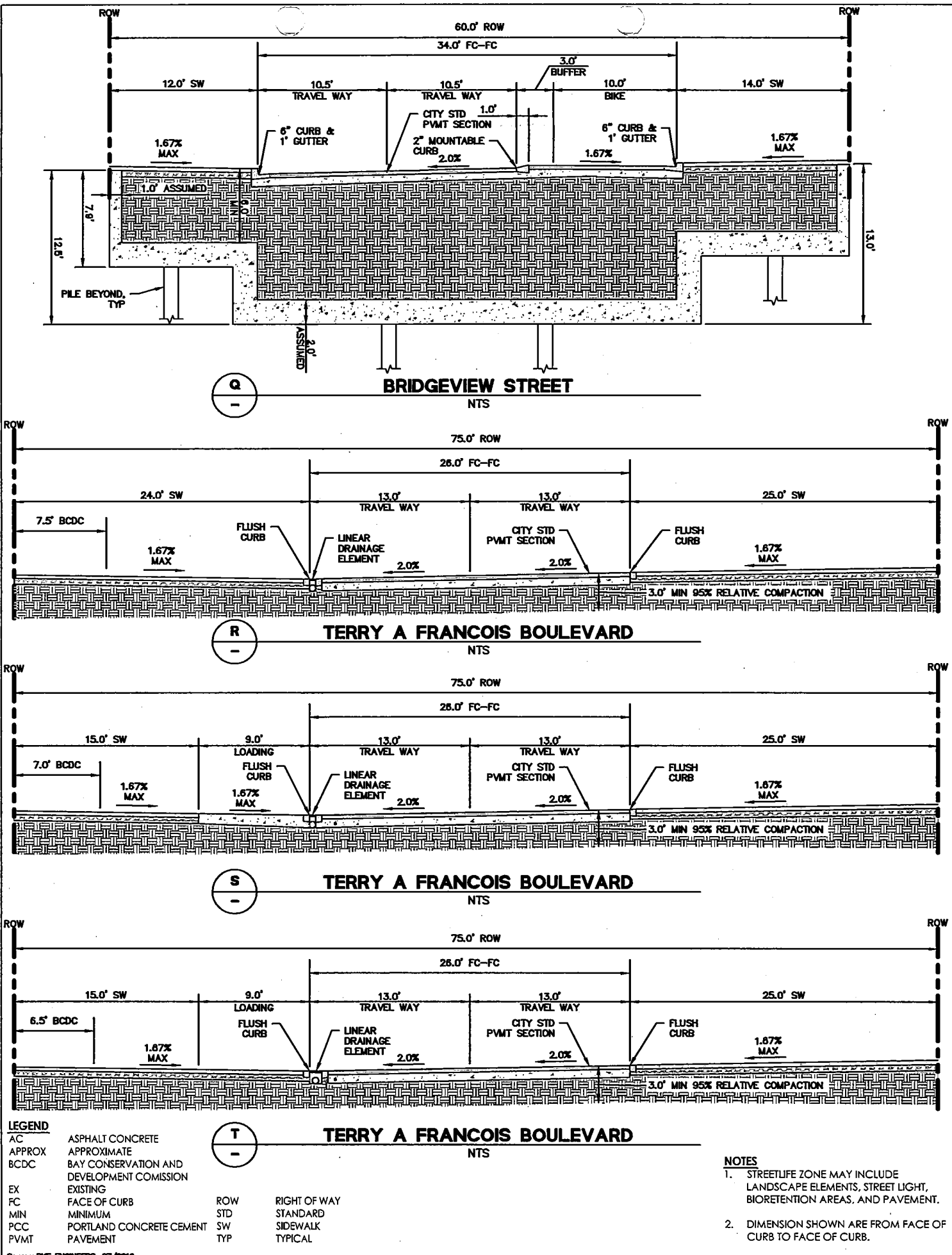

LEGEND

AC	ASPHALT CONCRETE	ROW	RIGHT OF WAY
APPROX	APPROXIMATE	STD	STANDARD
BCDC	BAY CONSERVATION AND DEVELOPMENT COMMISSION	SW	SIDEWALK
EX	EXISTING	TYP	TYPICAL
FC	FACE OF CURB		
MIN	MINIMUM		
PCC	PORTLAND CONCRETE CEMENT PAVEMENT		

- NOTES**
- STREETLIFE ZONE MAY INCLUDE LANDSCAPE ELEMENTS, STREET LIGHT, BIORETENTION AREAS, AND PAVEMENT.
 - DIMENSION SHOWN ARE FROM FACE OF CURB TO FACE OF CURB.

DRAWING NAME: \\BKF-SF\Vol4\2008\080006\Mission Rock\ENG\Exhibits\Infrastructure Plan Exhibits\Plotted Sheets\Figure 8.5-8.12 Typical Street Cross Sections.dwg
 PLOT DATE: 07-15-17
 PLOTTED BY: FEL

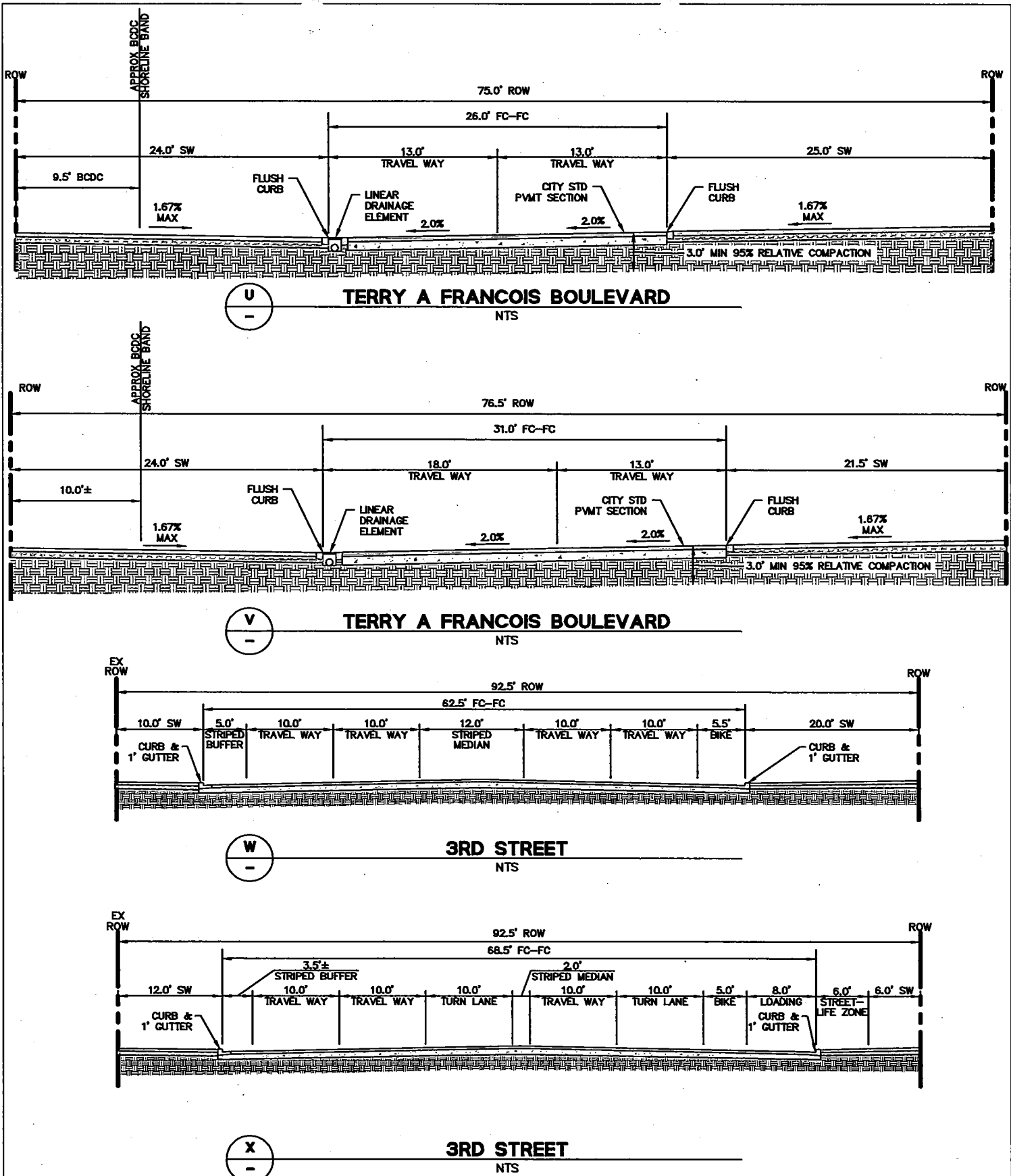

LEGEND	
AC	ASPHALT CONCRETE
APPROX	APPROXIMATE
BCDC	BAY CONSERVATION AND DEVELOPMENT COMMISSION
EX	EXISTING
FC	FACE OF CURB
MIN	MINIMUM
PCC	PORTLAND CONCRETE CEMENT
PVMT	PAVEMENT
ROW	RIGHT OF WAY
STD	STANDARD
SW	SIDEWALK
TYP	TYPICAL

- NOTES**
- STREETLIFE ZONE MAY INCLUDE LANDSCAPE ELEMENTS, STREET LIGHT, BIORETENTION AREAS, AND PAVEMENT.
 - DIMENSION SHOWN ARE FROM FACE OF CURB TO FACE OF CURB.

Source: BKF ENGINEERS, 07/2016

DRAWING NAME: \\BCE-SF\vol14\2008\080808_Mission_Rock\ENG\Exhibits\Infrastructure_Plan_Exhibits\Plotted_Sheets\Limits.dwg
 PLOT DATE: 07-13-17
 PLOTTED BY: FELI
 Source: BKF ENGINEERS, 07/2016

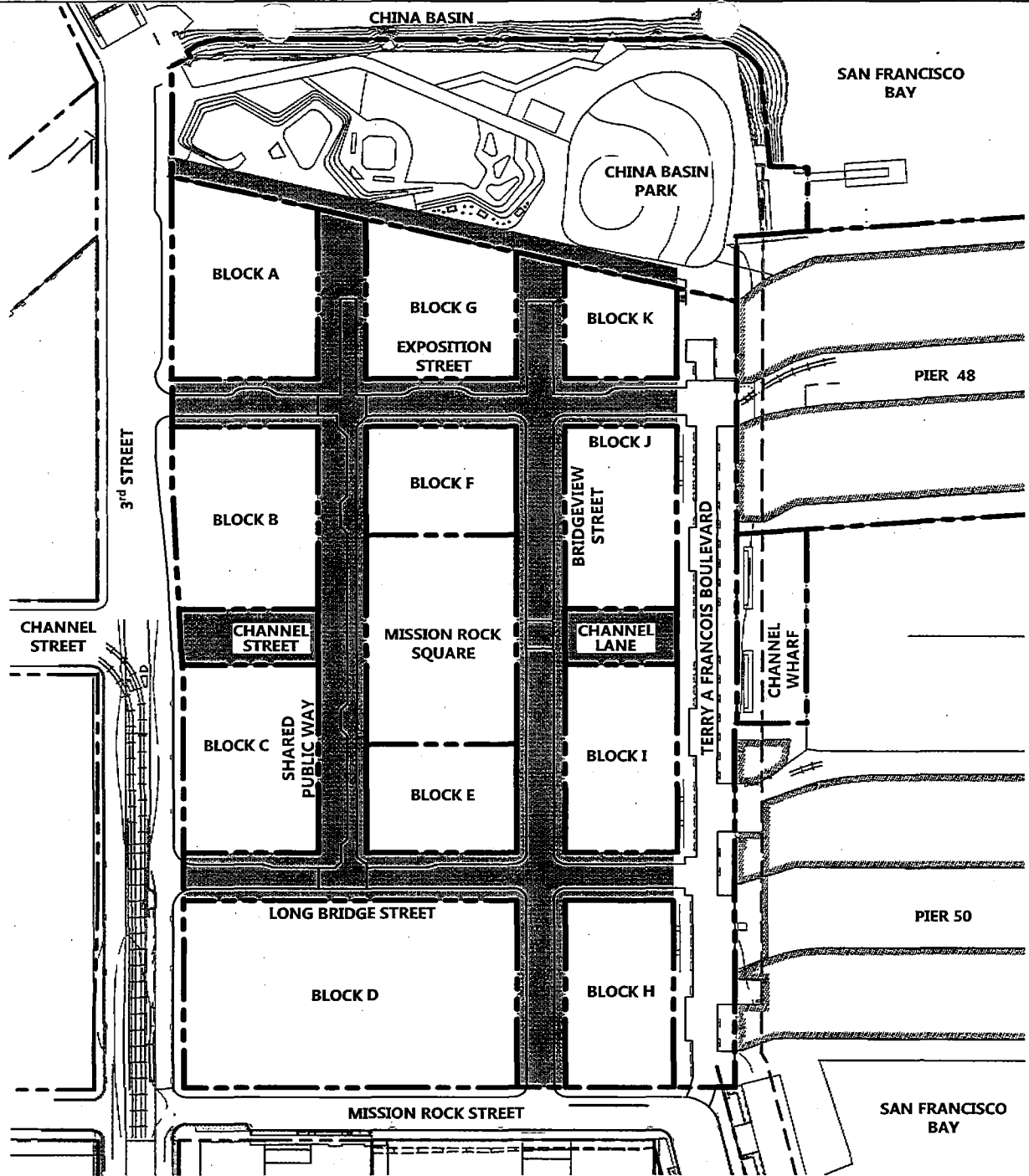

LEGEND

- PROPOSED PARCEL LINE
- EXISTING PARCEL LINE
- STRUCTURED STREET OR OPEN SPACE AREA (210,000 SF)

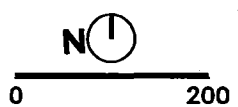

DRAWING NAME: \\BKF-SF\vol1\2008\080000_Mission_Rock\EMD\Exhibits\Infrastructure_Plan_Exhibits\Plotted_Sheets\Figure 8.14 Typical Structured Streets.dwg
 PLOT DATE: 07-13-17
 PLOTTED BY: boyo

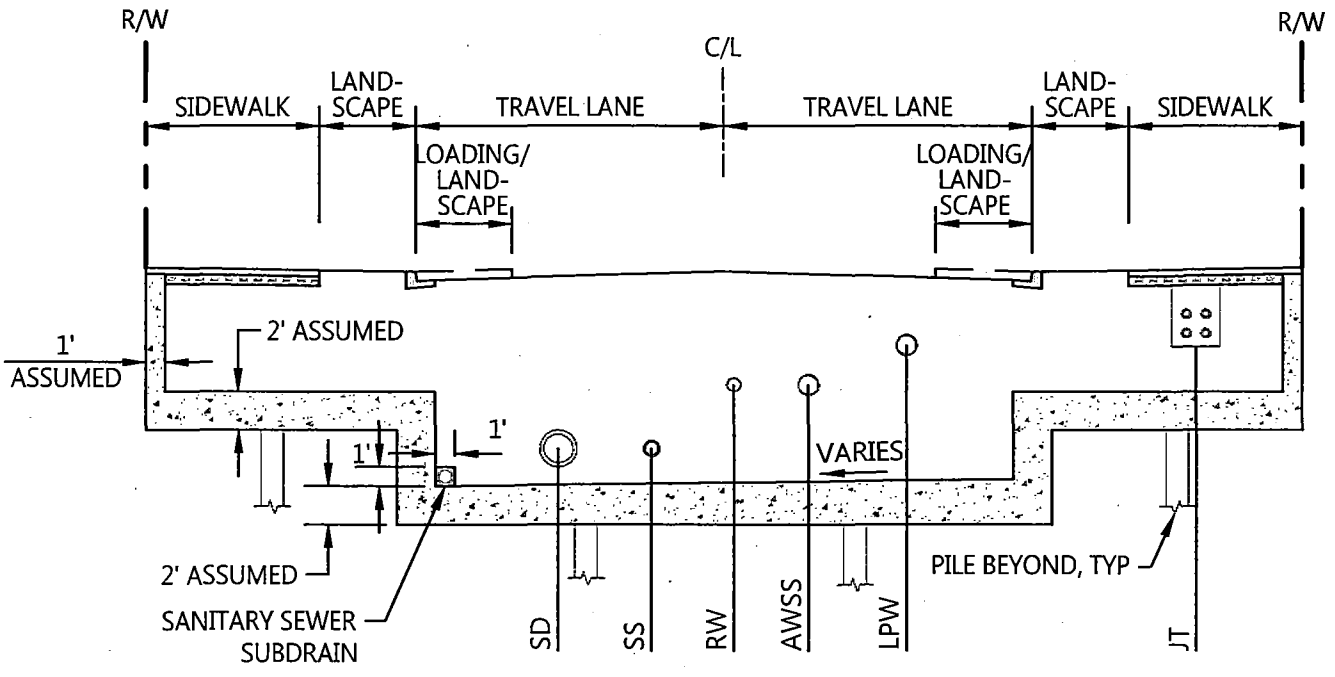

TYPICAL STRUCTURED STREET SECTION
 NTS

FIGURE 8.15: PEDESTRIAN CIRCULATION + ACCESSIBILITY

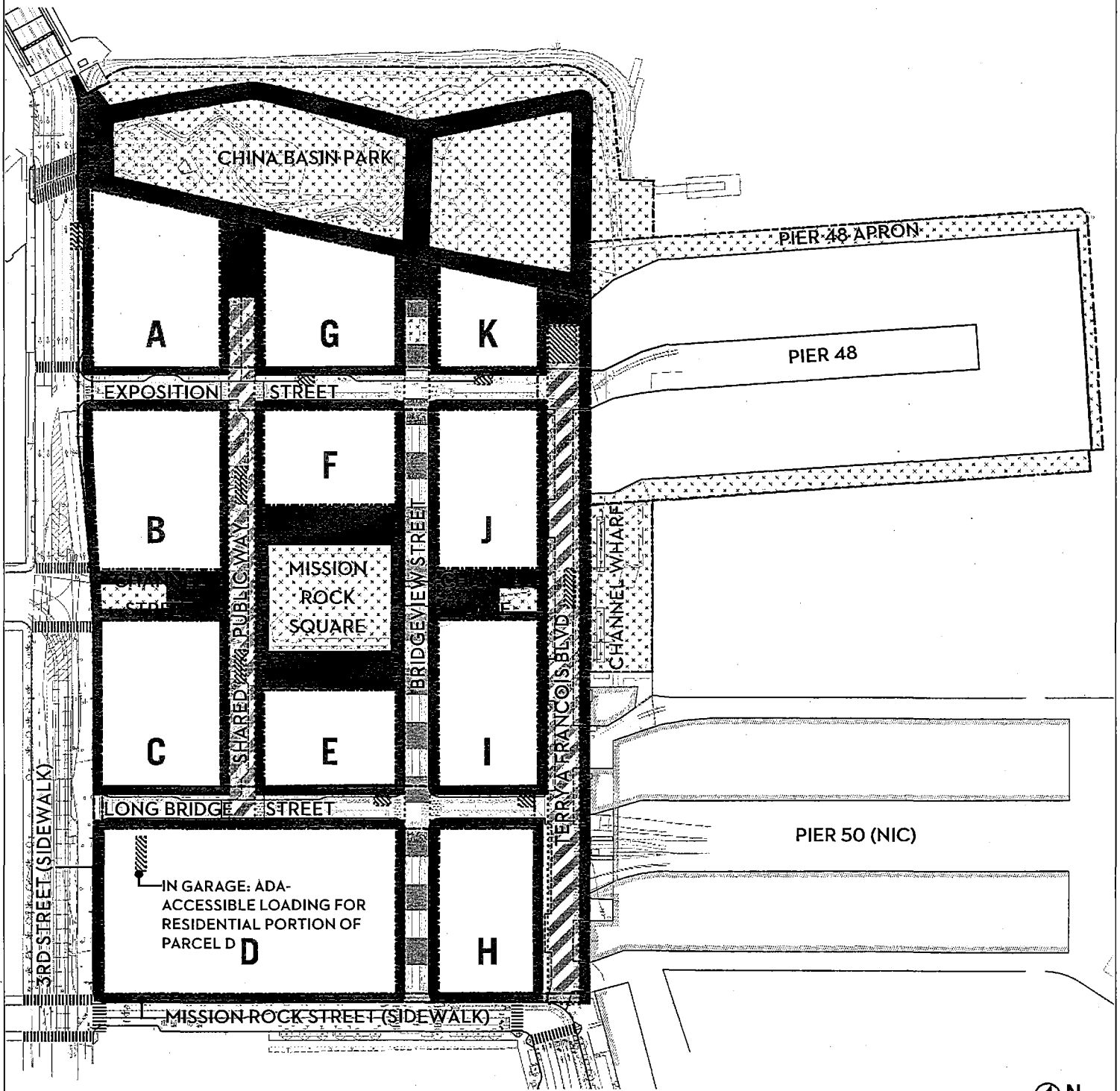



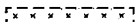

FIGURE 8.15: PEDESTRIAN CIRCULATION + ACCESSIBILITY

- | | |
|---|---|
| <p> < 5% Path of Travel (all sidewalks)</p> <ul style="list-style-type: none"> - Accessible path of travel to all potential building entrance locations <p> Accessible Loading Stall/Dedicated Passenger Loading</p> <ul style="list-style-type: none"> - Delineated drop-off area within ROW - Located in central areas - Curb ramps where required by curb condition | <p> Shared Street with Flush Curb</p> <ul style="list-style-type: none"> - Delineated drop-off areas as noted - Entire vehicular area can be used for paratransit drop-off <p> Vehicular Street with Reduced-Height Curb</p> <ul style="list-style-type: none"> - 4" curb accessible by paratransit vehicles for drop-off <p> Open Space (Shown for reference only)</p> |
|---|---|

Source: CMG LANDSCAPE ARCHITECTURE, 07/2016

FIGURE 8.16: VEHICULAR CIRCULATION

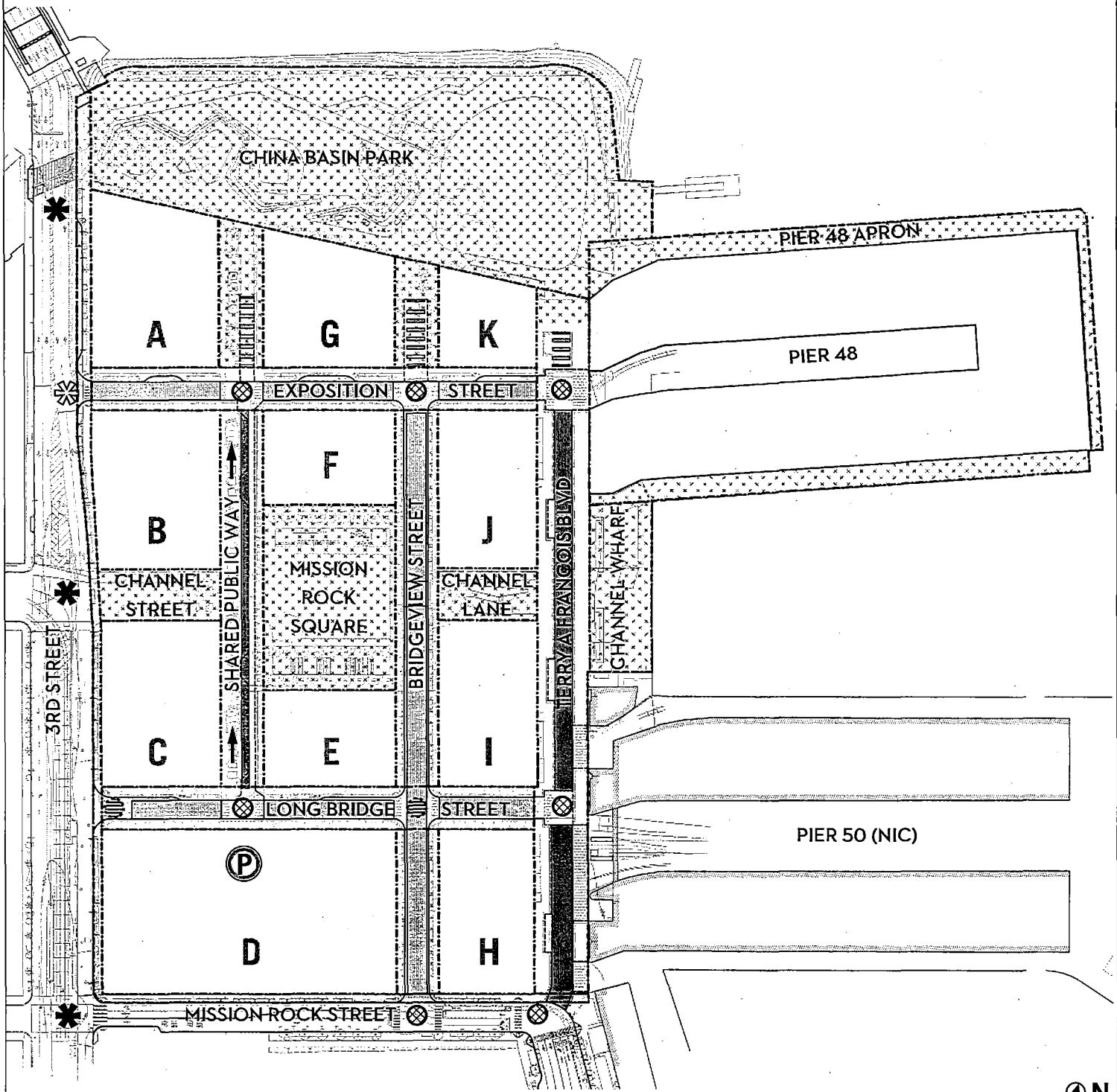





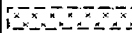





FIGURE 8.16: VEHICULAR CIRCULATION

- | | | | |
|---|---------------------------------------|---|----------------------------------|
|  | Shared Street (No Street Parking) |  | Shared Site Parking Location |
|  | 2-Way Street (No Street Parking) |  | Stop Sign: All-Way |
|  | Paseo with Emergency Vehicle Access |  | Stop Sign: At Through Streets |
|  | Open Space (Shown for reference only) |  | Existing Signalized Intersection |
|  | Direction of 1-Way Traffic |  | Proposed Signalized Intersection |

Source: CMG LANDSCAPE ARCHITECTURE, 07/2016

FIGURE 8.17: BICYCLE CIRCULATION + FACILITIES

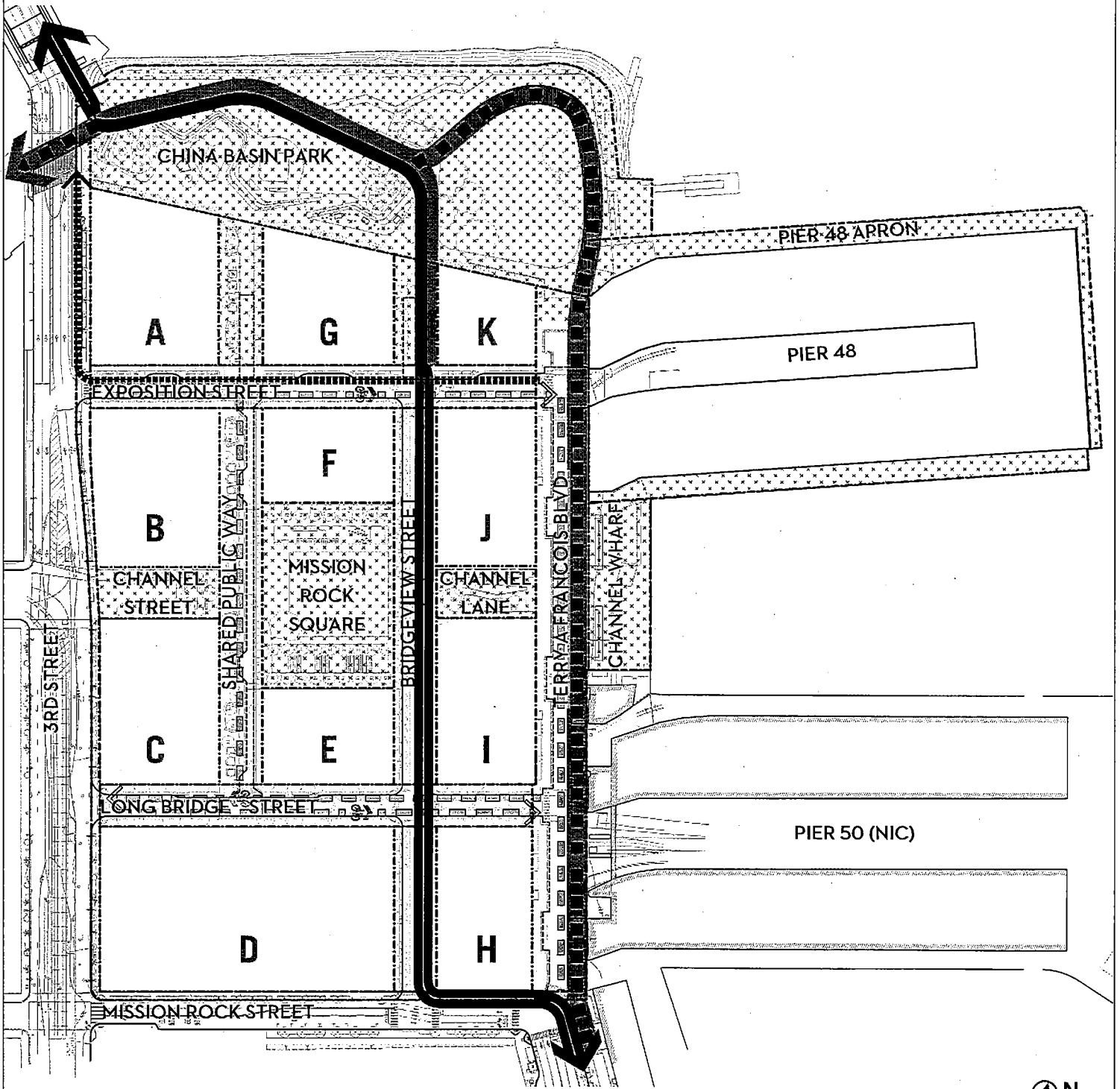





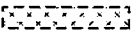

FIGURE 8.17: BICYCLE CIRCULATION + FACILITIES

- | | |
|--|---|
| <ul style="list-style-type: none">  Blue Greenway: China Basin Park
- Primary N-S Bicycle Connection: Multi-Use Trail  Blue Greenway: Terry A Francois Blvd and China Basin Park
- Multi-Use Trail  Protected Cycle Track: Bridgeview + Mission Rock Streets
- Primary N-S Bicycle Connection | <ul style="list-style-type: none">  Painted Bike Lane  Sharrows / Shared Travelway  Open Space (Shown for reference only) |
|--|---|

Source: CMG LANDSCAPE ARCHITECTURE, 07/2016

FIGURE 8.18: LOADING, SERVICING, + PARKING

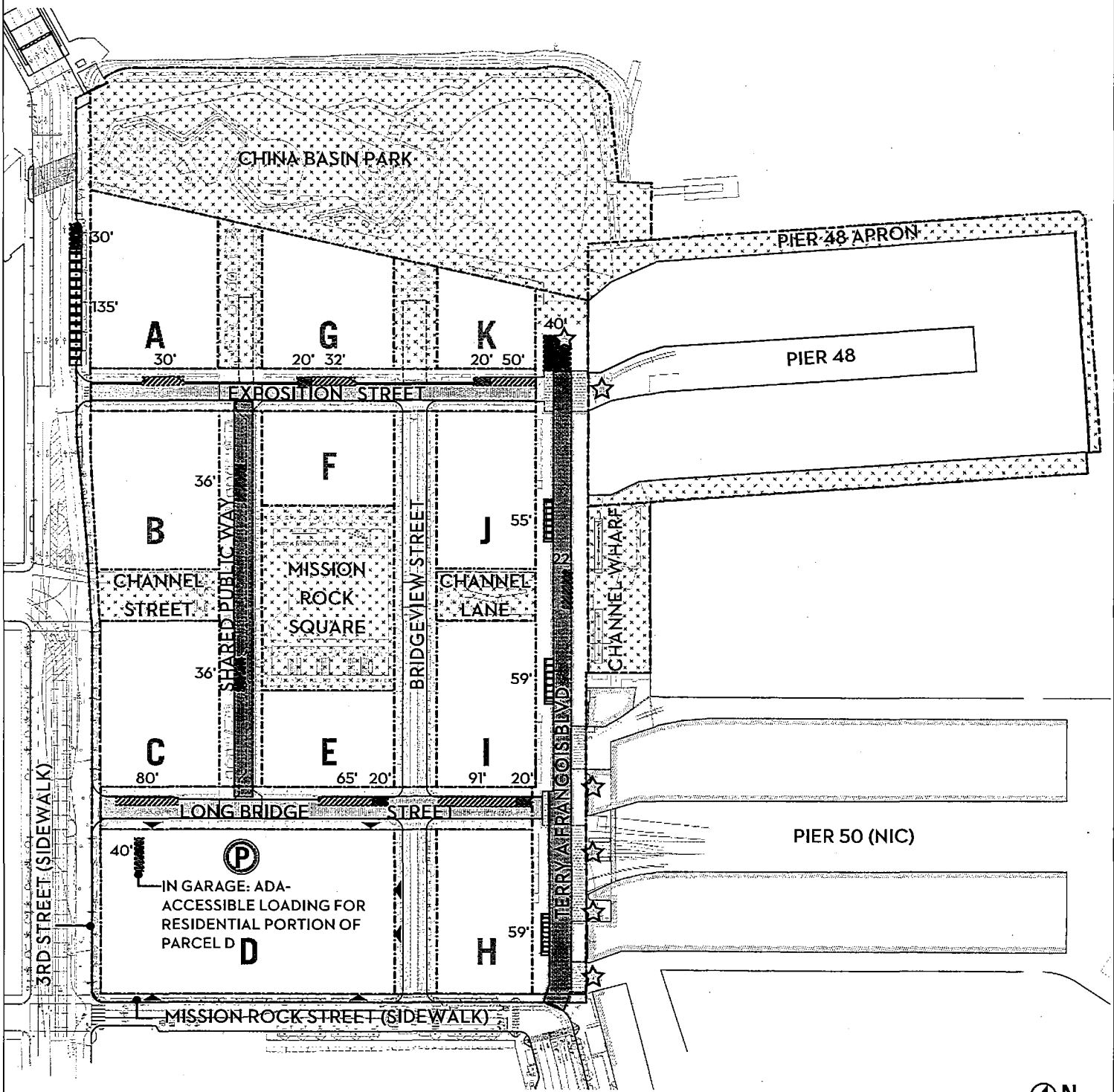

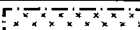







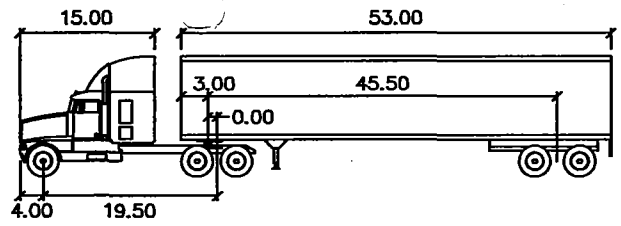

FIGURE 8.18: SERVICING AND LOADING

- | | | | |
|---|--|---|---------------------------------------|
|  | Service Street |  | Open Space (Shown for reference only) |
|  | Shared Street (Flush Curb) |  | Large Truck/Vehicle Access |
|  | Commercial Delivery Zone (Length as Noted) |  | Garage Driveway Location |
|  | Accessible Loading (Length as Noted) |  | Shared Parking Facility |
|  | Time-Limited Commercial Delivery Zone (Accessible Loading All Other Times) | | |

Source: CMG LANDSCAPE ARCHITECTURE, 07/2016



WB-67

	feet		feet
Tractor Width	: 8.00	Lock to Lock Time	: 6.0
Trailer Width	: 8.50	Steering Angle	: 28.4
Tractor Track	: 8.00	Articulating Angle	: 75.0
Trailer Track	: 8.50		

WB-67 TRUCK TEMPLATE

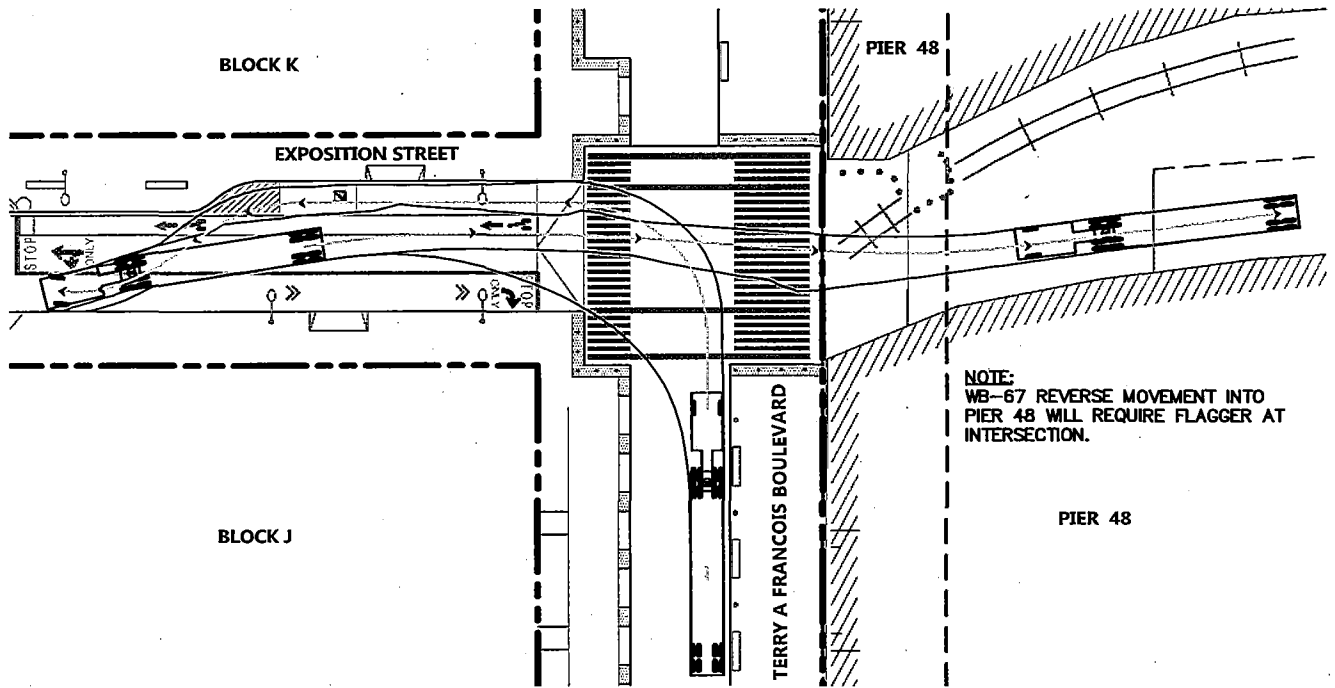

WB-67 TRUCK ENTERING PIER 48

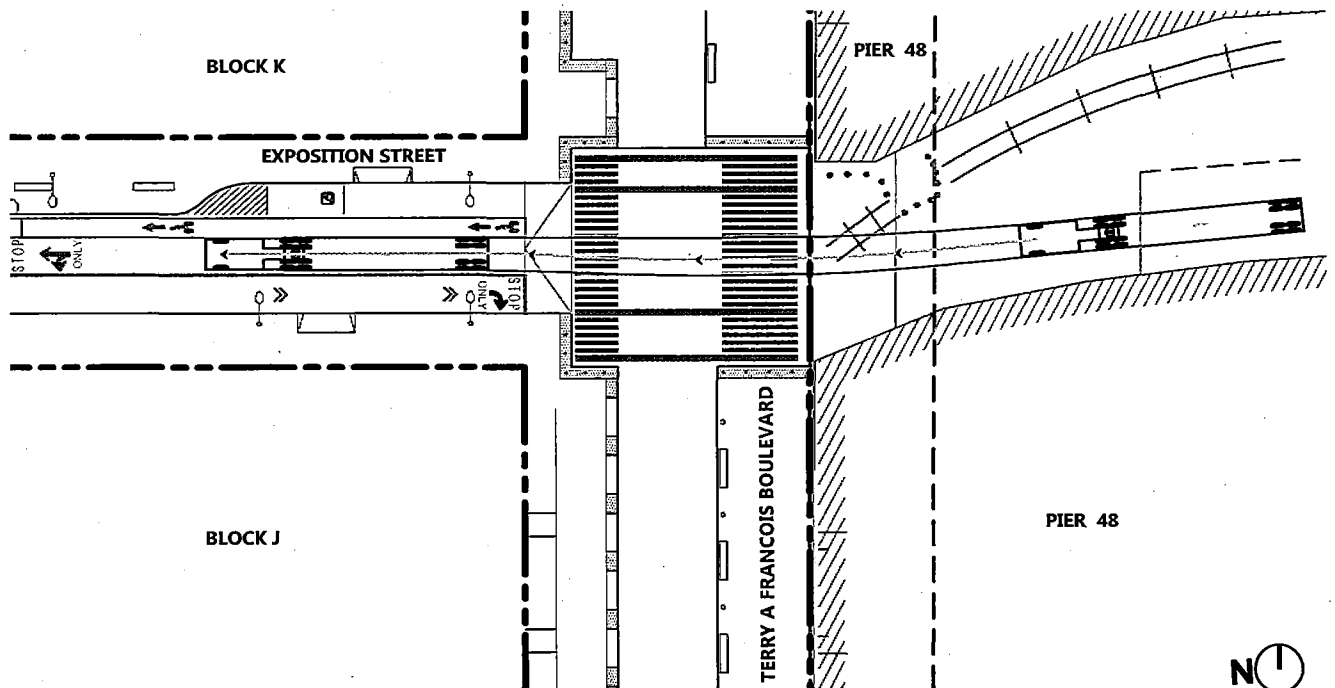

WB-67 TRUCK EXITING PIER 48

DRAWING NAME: \\bk1-sf\va\2008\000000_Mission_Rock\ENR\Exhibits\Infrastructure_Plan_Exhibits\Plotted_Sheets\Figure 8.19-20_Pier_Turning.dwg
PLOT DATE: 07-13-17 PLOTTED BY: FEL

Source: ENR ENGINEERS, 07/2016

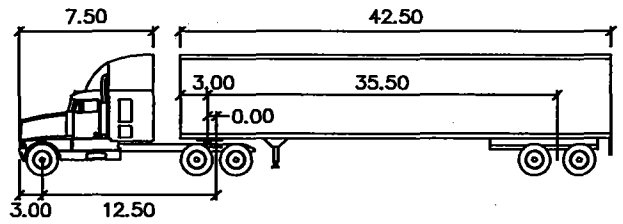

WB-50

Tractor Width	: 8.00	feet	Lock to Lock Time	: 6.0	feet
Trailer Width	: 8.50		Steering Angle	: 17.7	
Tractor Track	: 8.00		Articulating Angle	: 70.0	
Trailer Track	: 8.50				

WB-50 TRUCK TEMPLATE

BLOCK H

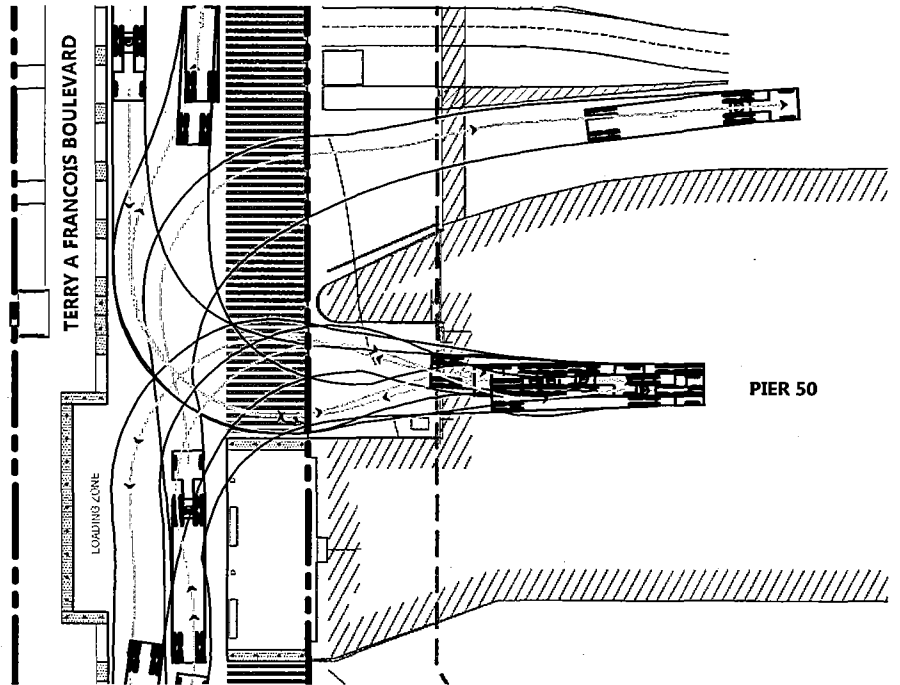

WB-50 TRUCK ENTERING PIER 50

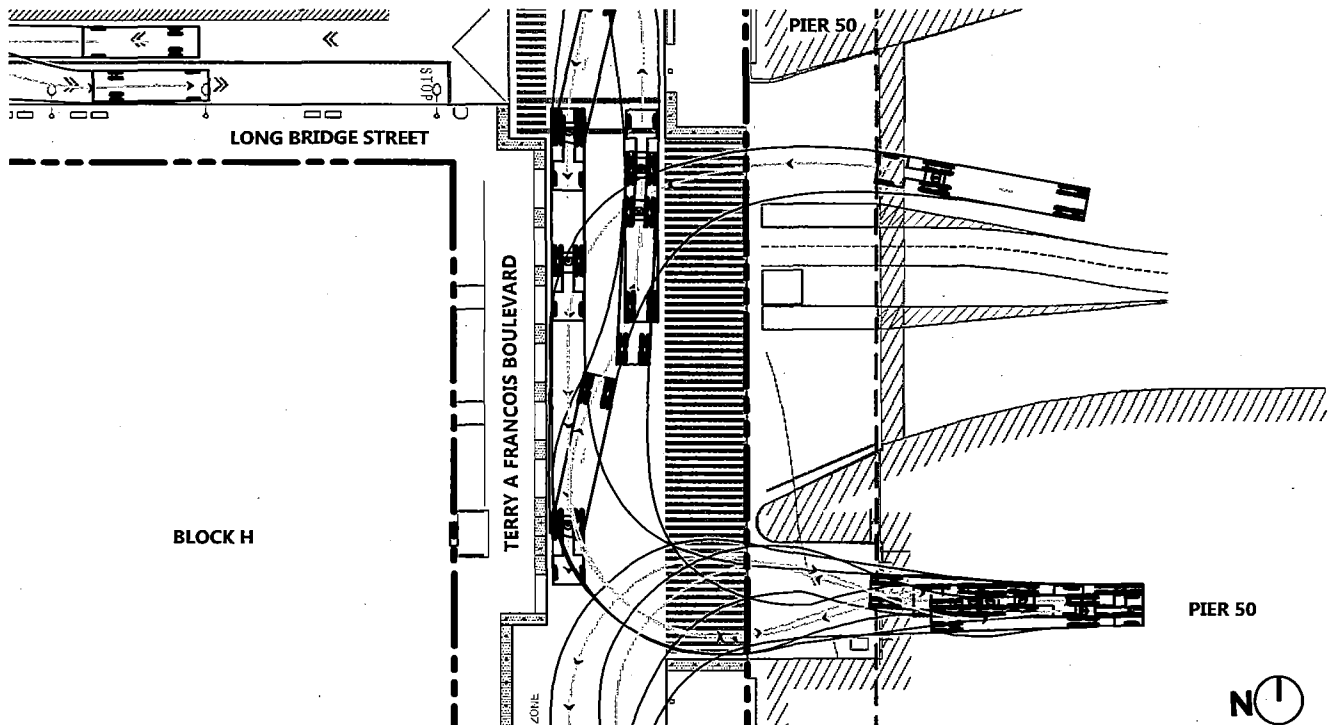

WB-50 TRUCK EXITING PIER 50

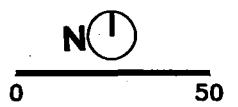

DRAWING NAME: \\DKF-SF\Vol4\2008\000006.Mission Rock\ENG\Exhibits\Infrastructure Plan Exhibits\Plotted Sheets\Figure 8.19-20 Pier Turning.dwg
PLOT DATE: 07-15-17 PLOTTED BY: boye

Source: BKF ENGINEERS, 07/2016

DRAWING NAME: \\BKF-SF\vol14\2008\0808006.Mission Rock\ENG\Exhibits\Infrastructure Plan Exhibits\Plotted Sheets\Figure 8.21 Conceptual Fire Truck Turning Analysis.dwg
 PLOT DATE: 07-13-17
 PLOTTED BY: FEL

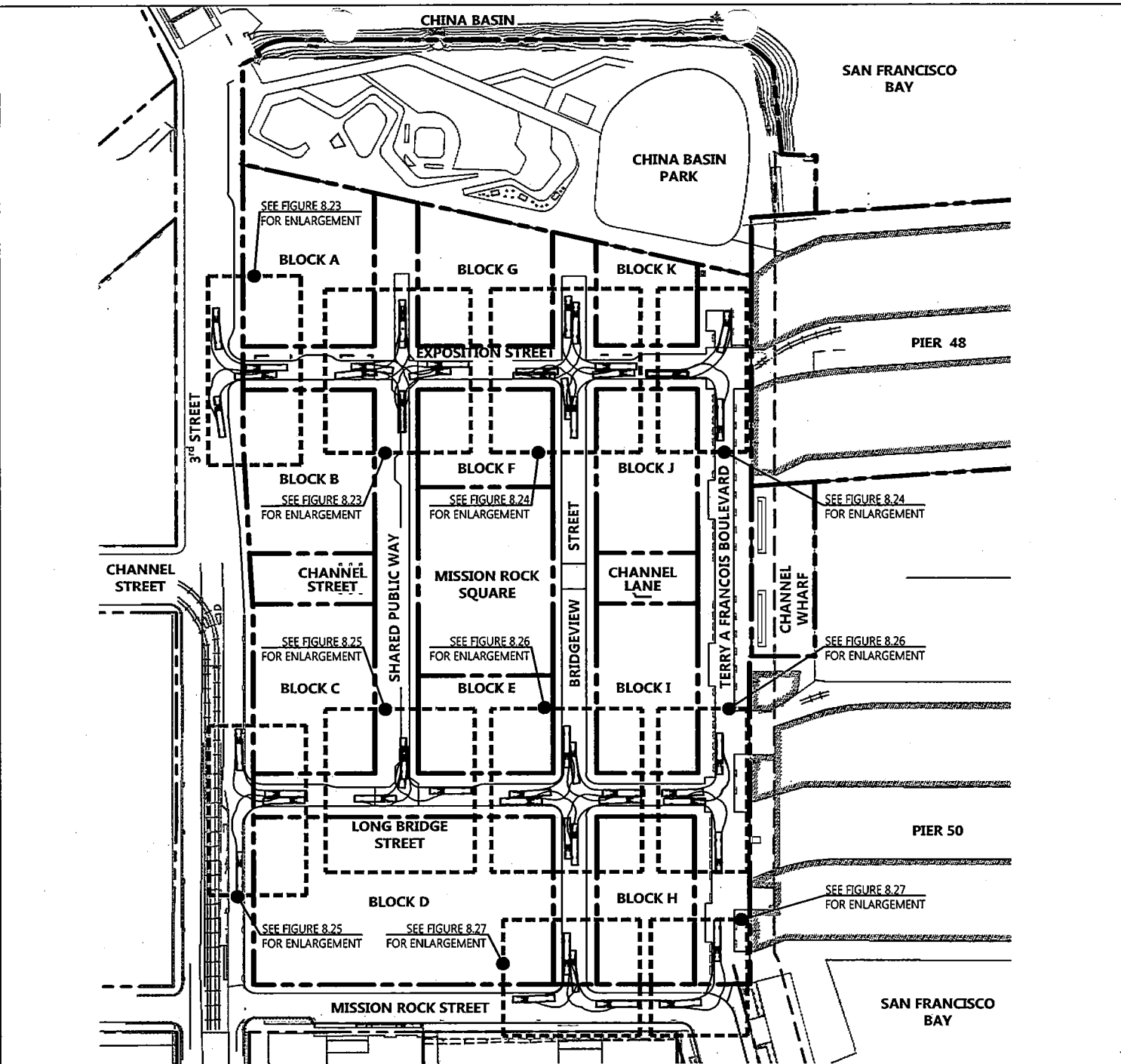

LEGEND

- PROPOSED PARCEL LINE
- - - EXISTING PARCEL LINE
- > PROPOSED FIRE TRUCK PATH

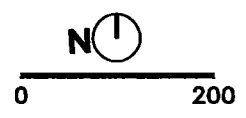

Source: BKF ENGINEERS, 07/2016

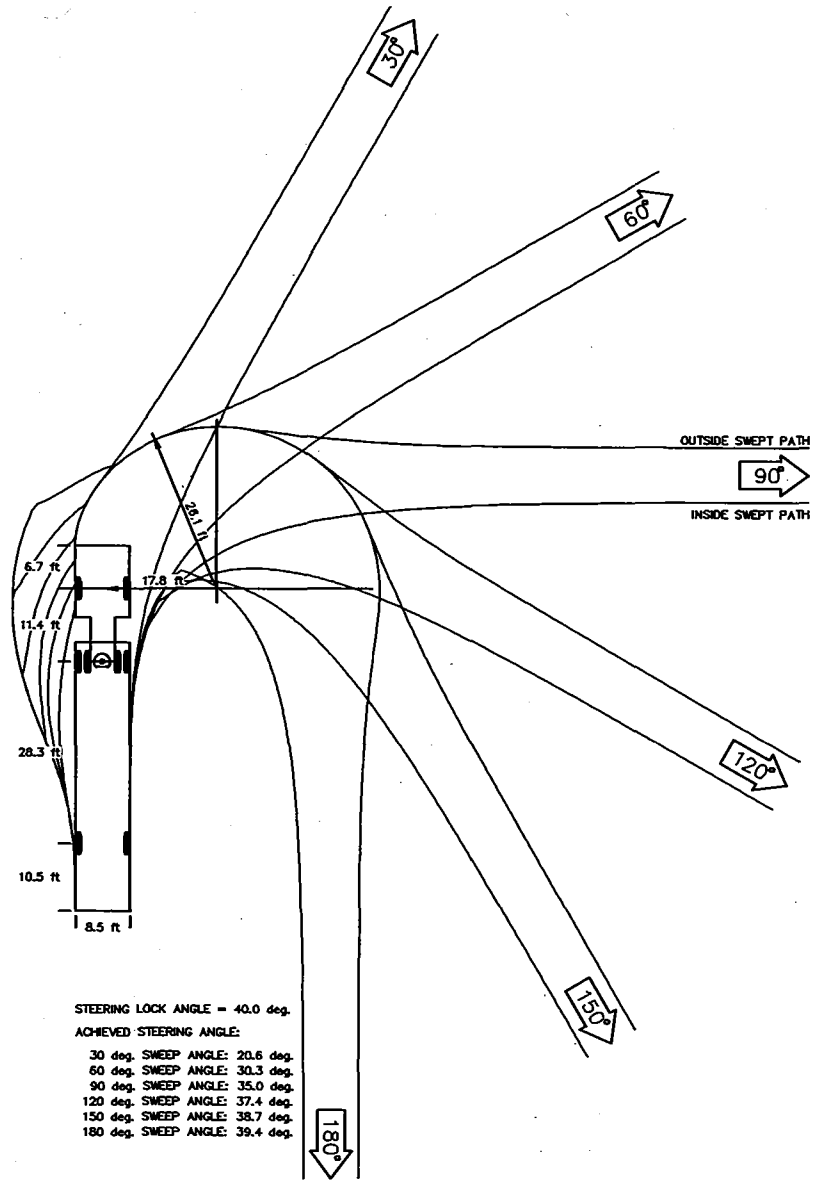

SFFD 57' Articulated_V2
Custom

(ft)
(c) 2014 Transit Solutions, Inc. All rights reserved.

0FT 10FT 20FT

DRAWING NAME: \\BKF-SF\vo14\2008\080000\Mission Rock\ENG\Exhibits\Infrastructure Plan Exhibit\Plotted Sheets\Figure 8.22 Truck Turning Template.dwg
PLOT DATE: 07-13-17
PLOTTED BY: FEL

Source: BKF ENGINEERS, 07/2016

DRAWING NAME: \\BKF-SF\vol14\2008\060000_Mission_Rock\Exhibits\Infrastructure_Plan_Exhibits\Plotted_Sheets\Figure 8.23-8.27 Truck Turning Enlargements.dwg
 PLOT DATE: 07-15-17
 PLOTTED BY: FELI

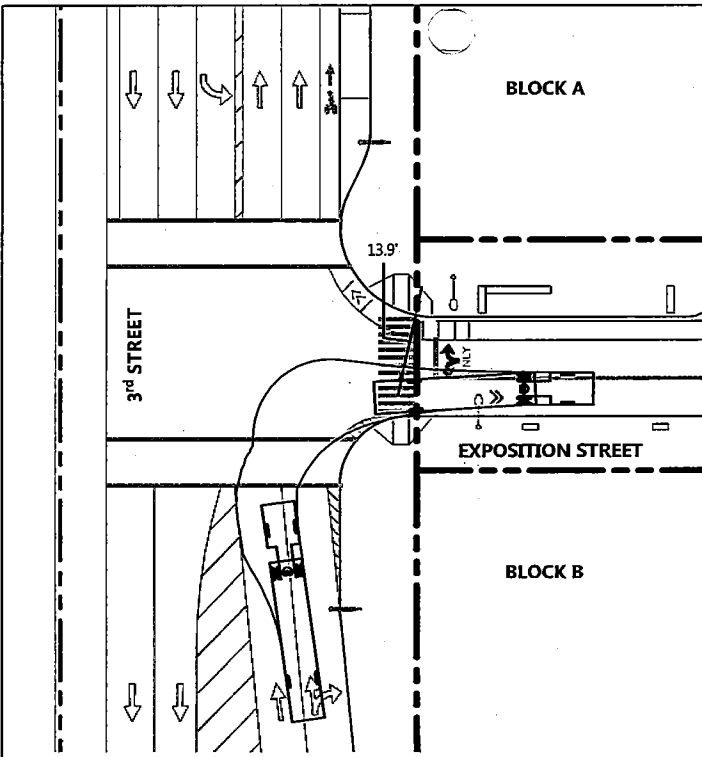

**EXPOSITION STREET & 3rd STREET INTERSECTION
(NW-SE)**

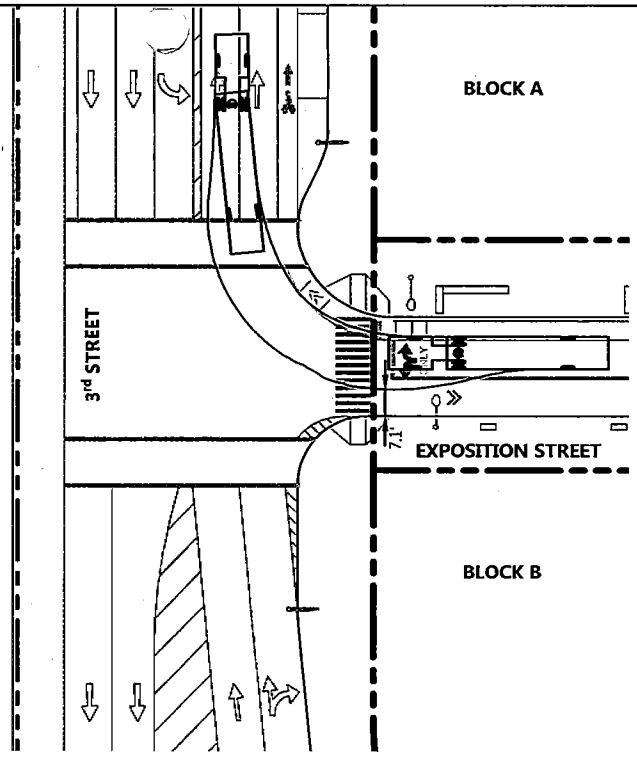

**EXPOSITION STREET & 3rd STREET INTERSECTION
(NE-SW)**

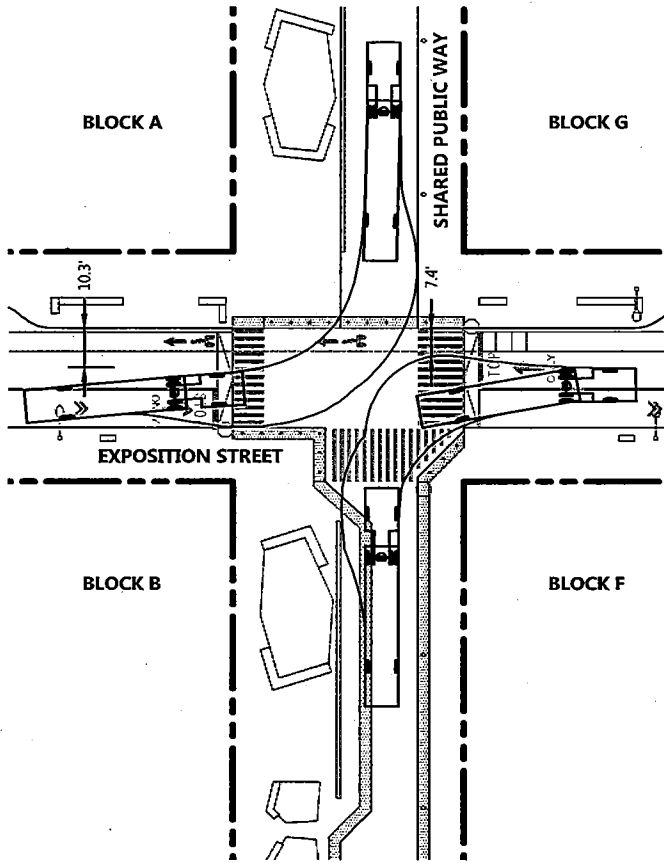

**EXPOSITION STREET & SHARED
PUBLIC WAY INTERSECTION
(NW - SE)**

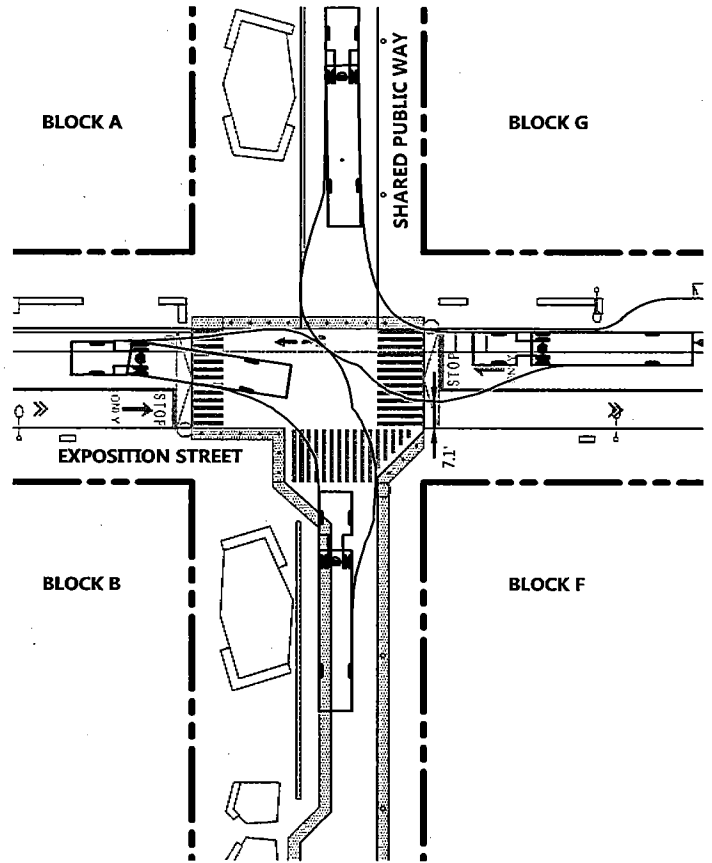

**EXPOSITION STREET & SHARED
PUBLIC WAY INTERSECTION
(NE-SW)**



0 50

DRAWING NAME: \\BKF-SF\vol14\2008\000006_Mission_Rock\Exhibits\Infrastructure_Plan_Exhibits\Plotted_Sheets\Figure 8.23-0.27 Truck Turning Enlargements.dwg
PLOT DATE: 07-13-17
Source: BKF ENGINEERS, 07/2016

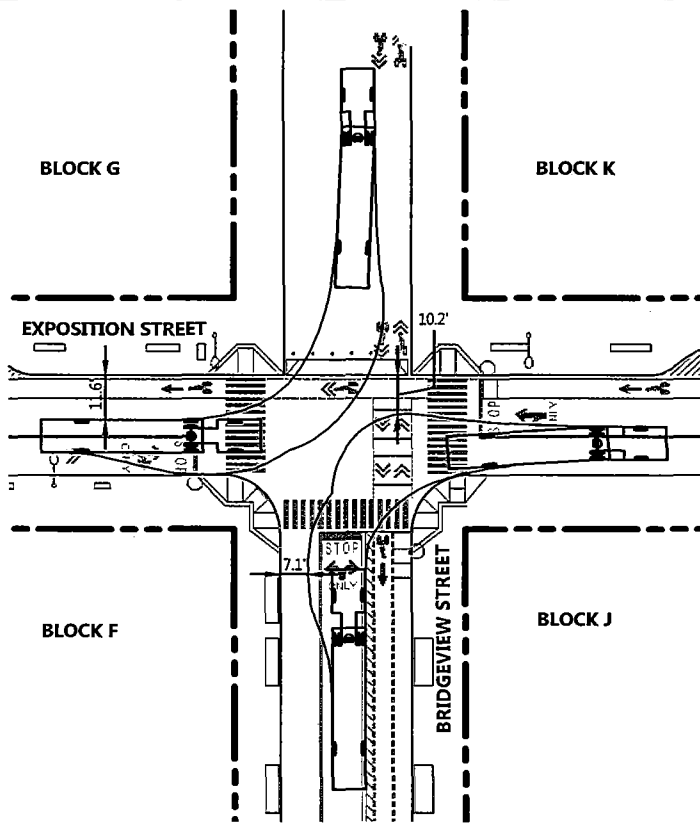

EXPOSITION STREET & BRIDGEVIEW STREET INTERSECTION (NW-SE)

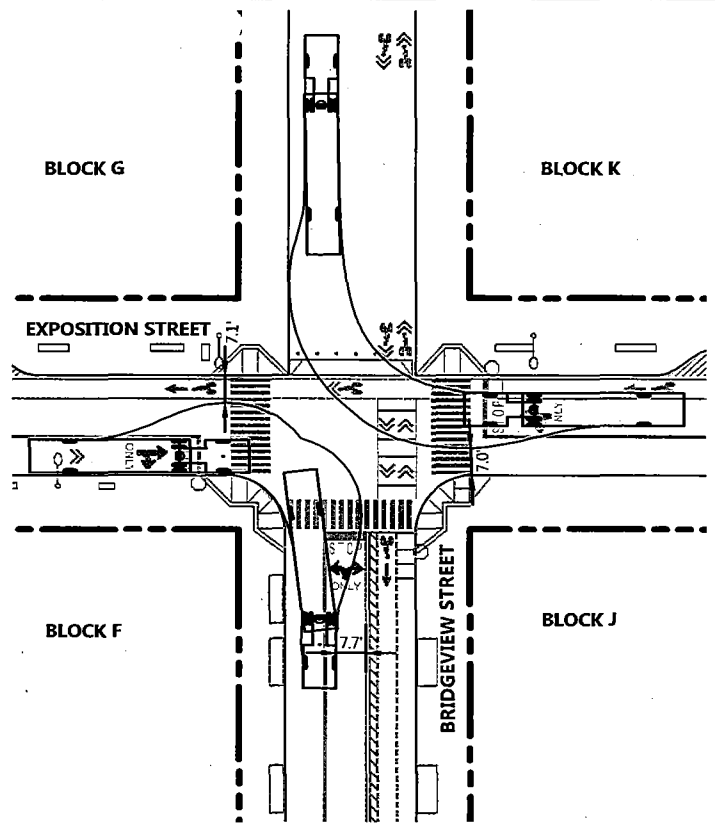

EXPOSITION STREET & BRIDGEVIEW STREET INTERSECTION (NE-SW)

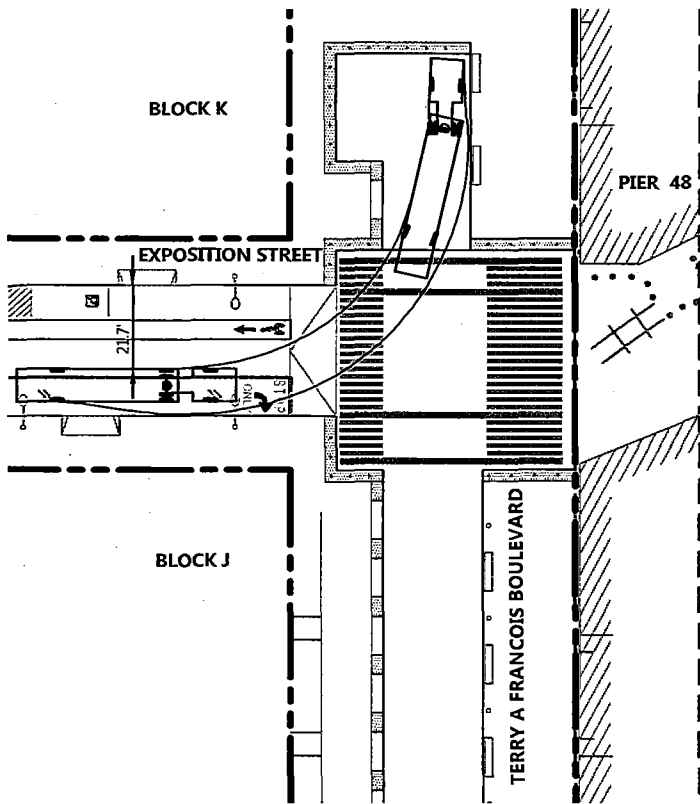

EXPOSITION STREET & TERRY A FRANCOIS BOULEVARD INTERSECTION (NW-SE)

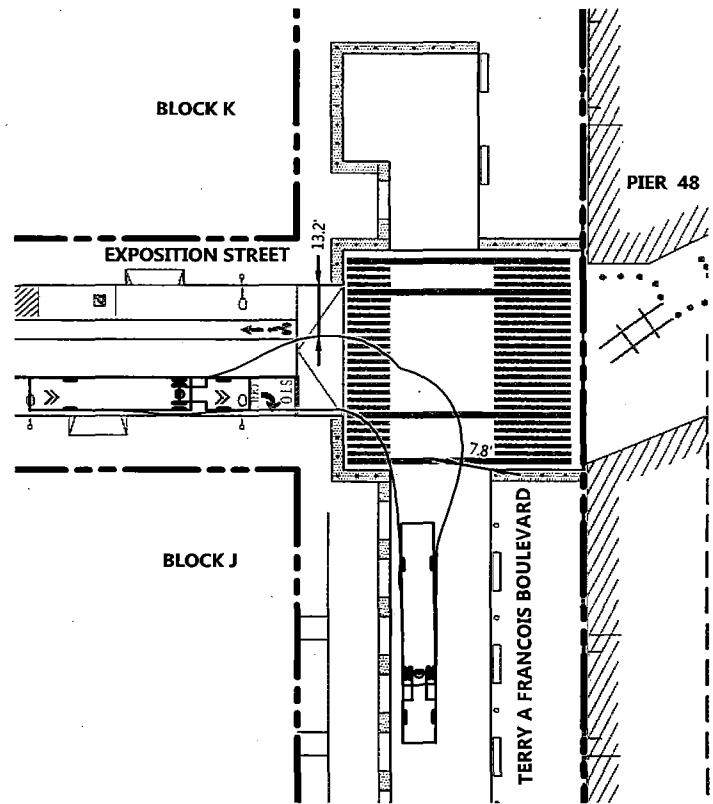

EXPOSITION STREET & TERRY A FRANCOIS BOULEVARD INTERSECTION (NE-SW)



0 50

DRAWING NAME: \\BKF-SFA\vol1\2016\080006_Mission_Rock\EMR\Exhibits\Infrastructure_Plan_Exhibits\Platted_Sheet\Figure_8.25-0.27_Truck_Turning_Enlargements.dwg
 PLOT DATE: 07-13-17
 PLOTTED BY: FELI

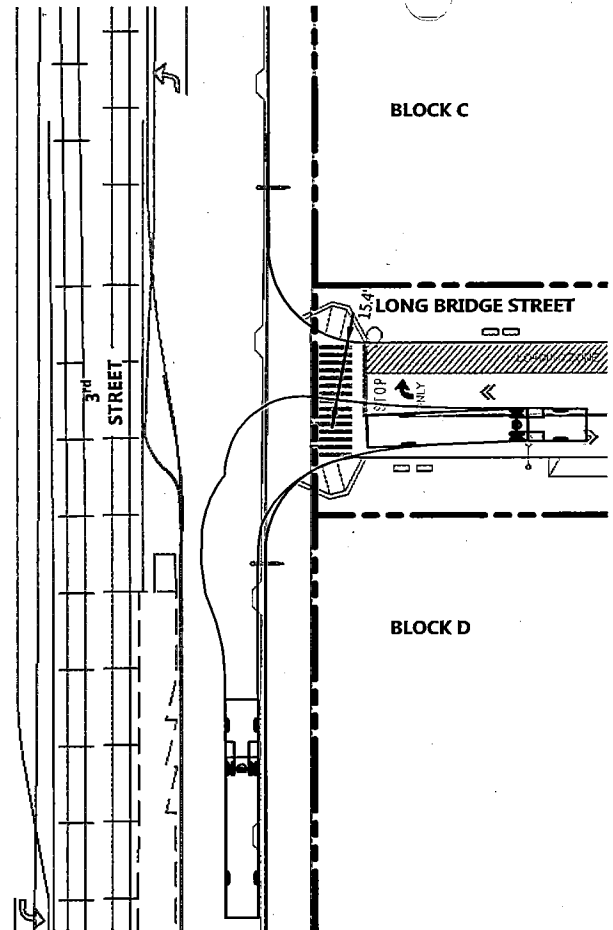

LONG BRIDGE STREET & 3rd STREET INTERSECTION (NW-SE)

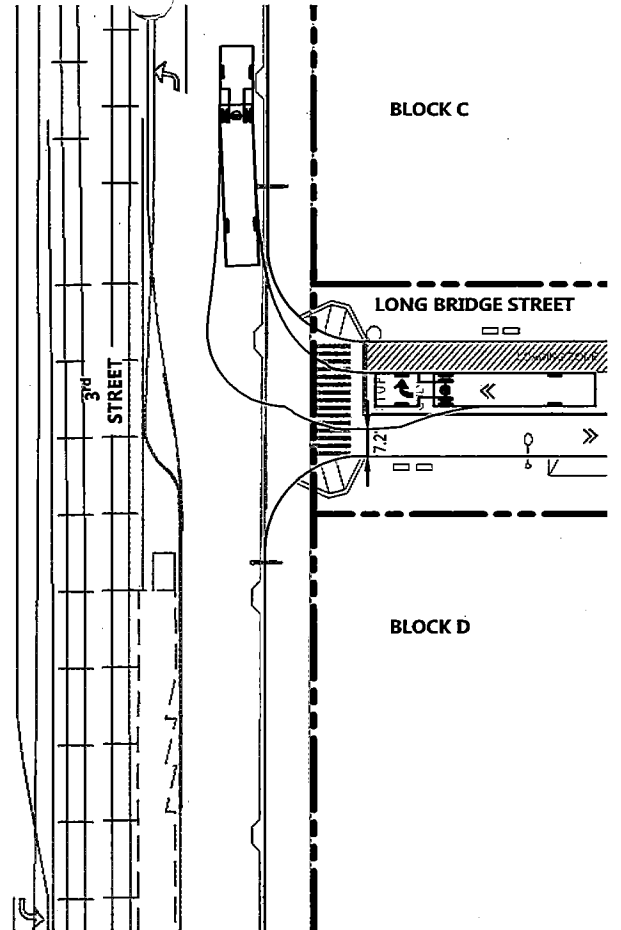

LONG BRIDGE STREET & 3rd STREET INTERSECTION (NE-SW)

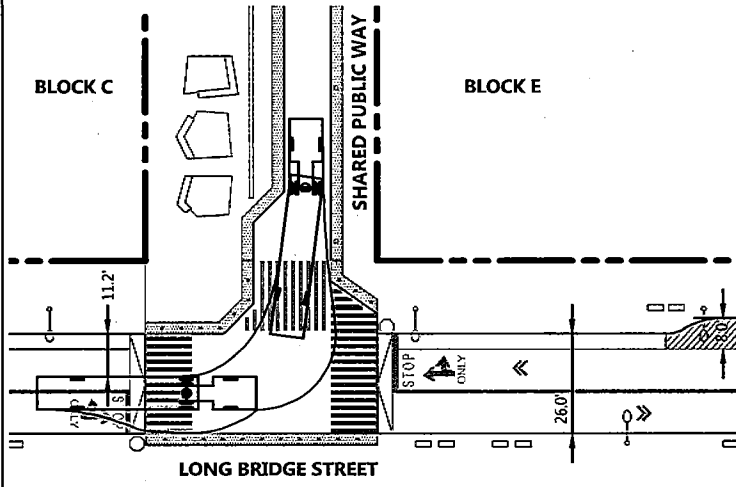

LONG BRIDGE STREET & SHARED PUBLIC WAY INTERSECTION (NW-SE)

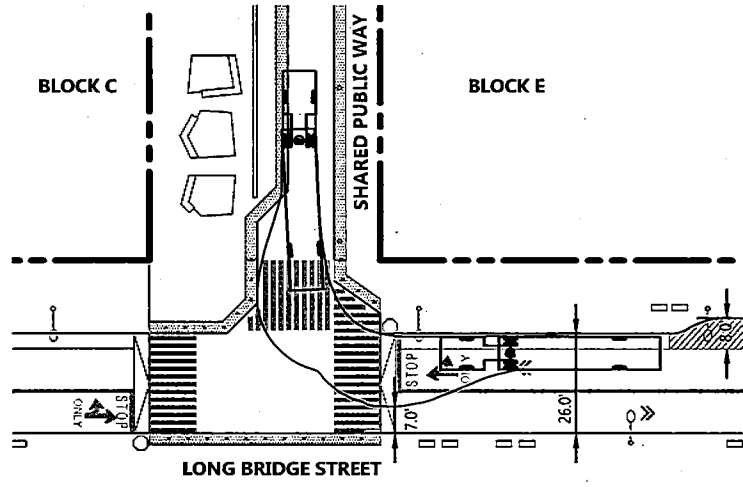

LONG BRIDGE STREET & SHARED PUBLIC WAY INTERSECTION (NE-SW)



0 50

Source: BMF ENGINEERS, 07/2016

DRAWING NAME: \\BKF-SF\vol14\2008\000000_Mission_Rock\ENG\Exhibits\Infrastructure Plan Exhibits\Plotted Sheets\Figure 8.23-0-27 Truck Turning Enlargements.dwg
 PLOT DATE: 07-13-17
 PLOTTED BY: FEL

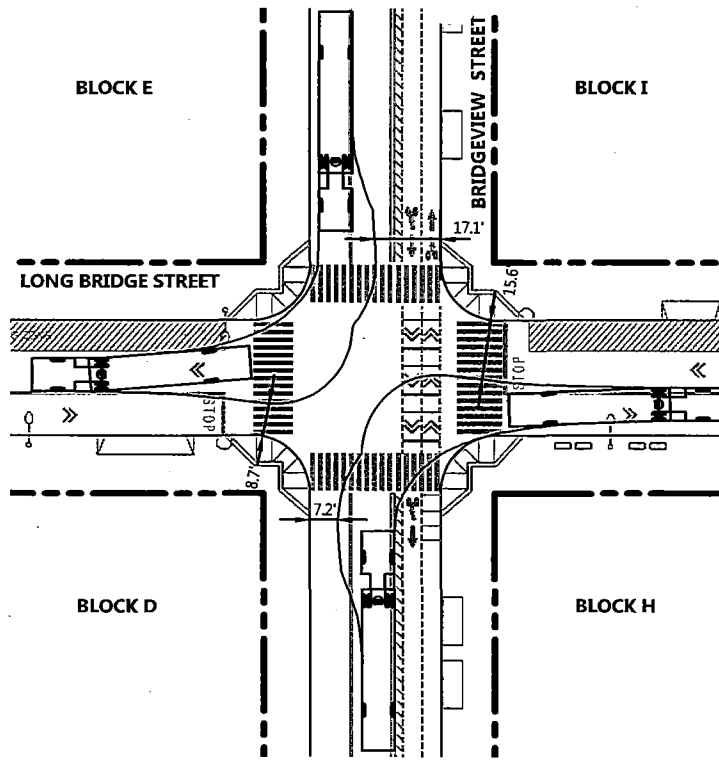

**LONG BRIDGE STREET & BRIDGEVIEW STREET
 INTERSECTION (NW-SE)**

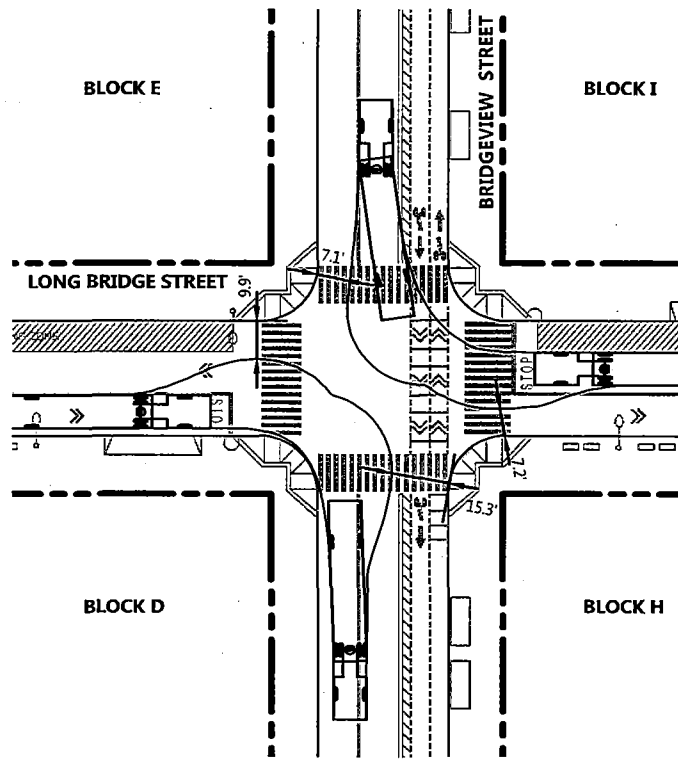

**LONG BRIDGE STREET & BRIDGEVIEW STREET
 INTERSECTION (NE-SW)**

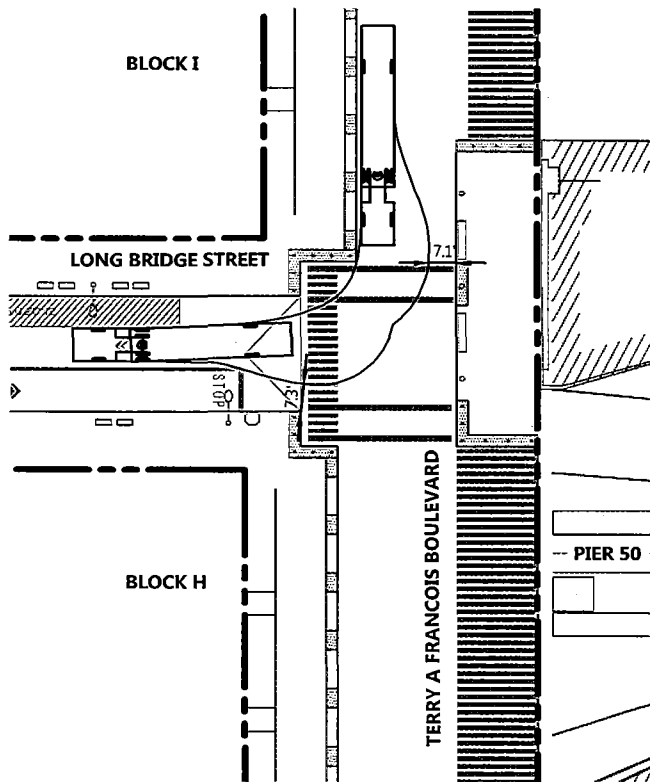

**LONG BRIDGE STREET & TERRY A FRANCOIS
 BOULEVARD INTERSECTION (NW-SE)**

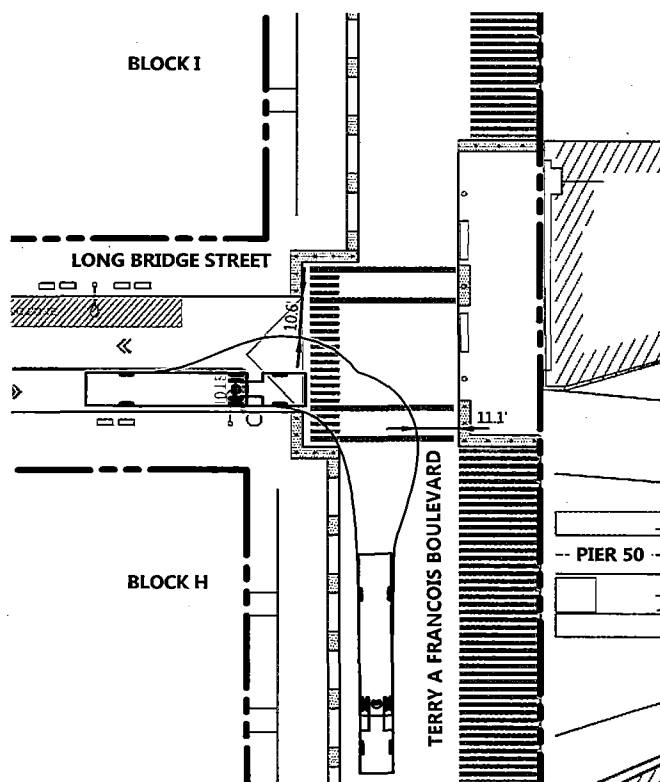

**LONG BRIDGE STREET & TERRY A FRANCOIS
 BOULEVARD INTERSECTION (NE-SW)**

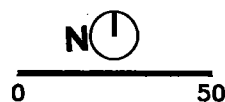

Source: BKF ENGINEERS, 07/2016

DRAWING NAME: \\BKF-SFA\voia\2018\000000_Mission_Rock\ENR\Exhibits\Infrastructure_Plan_Exhibits\Plotted_Sheets\Figure 8.23-8.27 Truck Turning Enlargements.dwg
PLOT DATE: 07-13-17

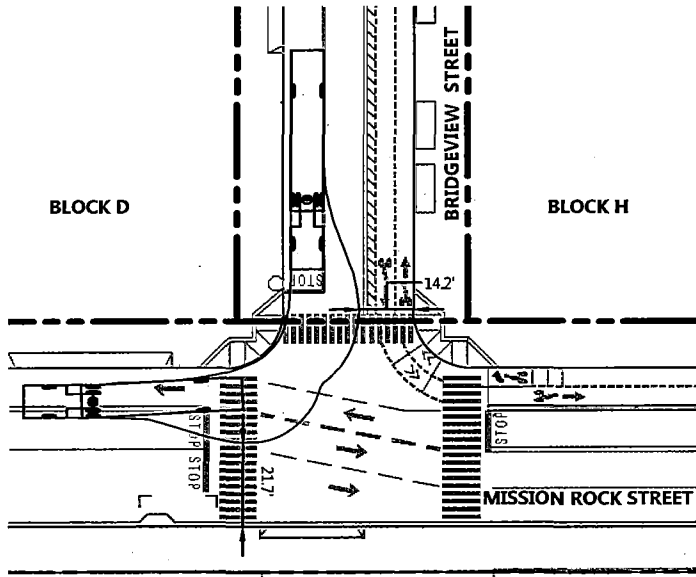

**MISSION ROCK STREET & BRIDGEVIEW STREET
INTERSECTION (NW-SE)**

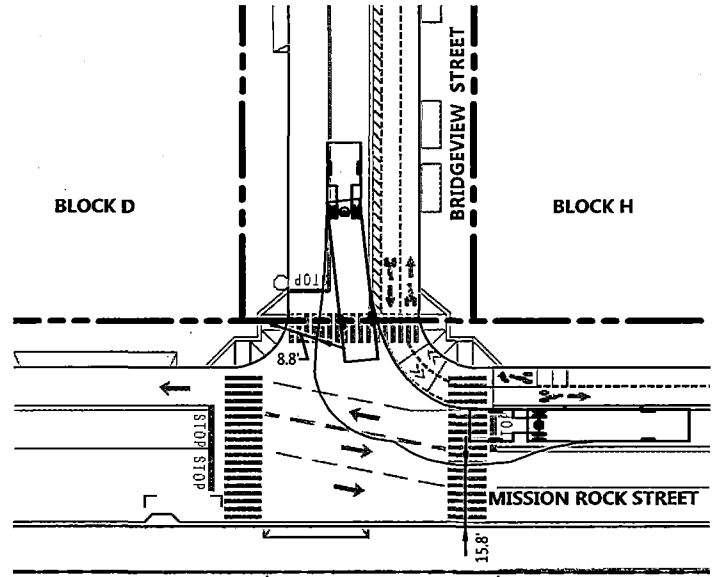

**MISSION ROCK STREET & BRIDGEVIEW STREET
INTERSECTION (NE-SW)**

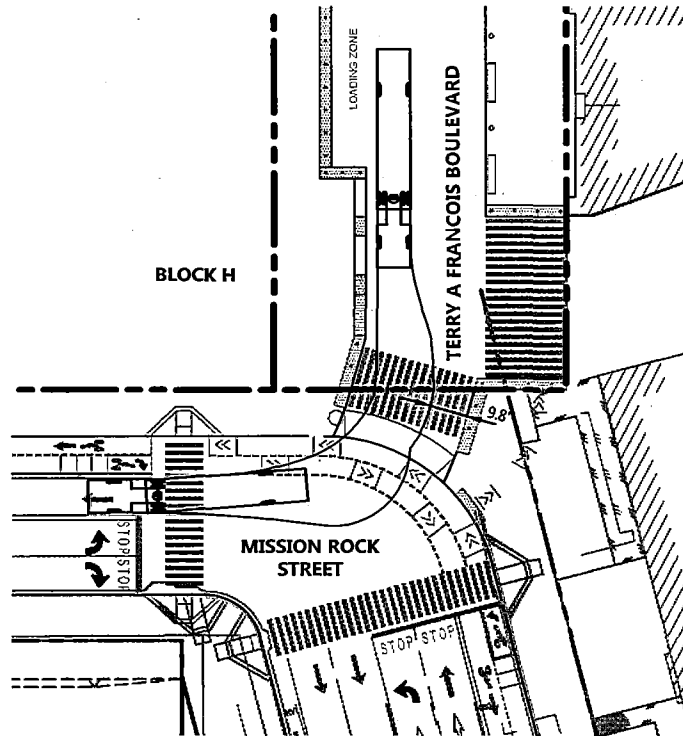

**MISSION ROCK STREET & TERRY A FRANCOIS
BOULEVARD INTERSECTION (NW-SE)**



0 50

Source: BKF ENGINEERS, 07/2016

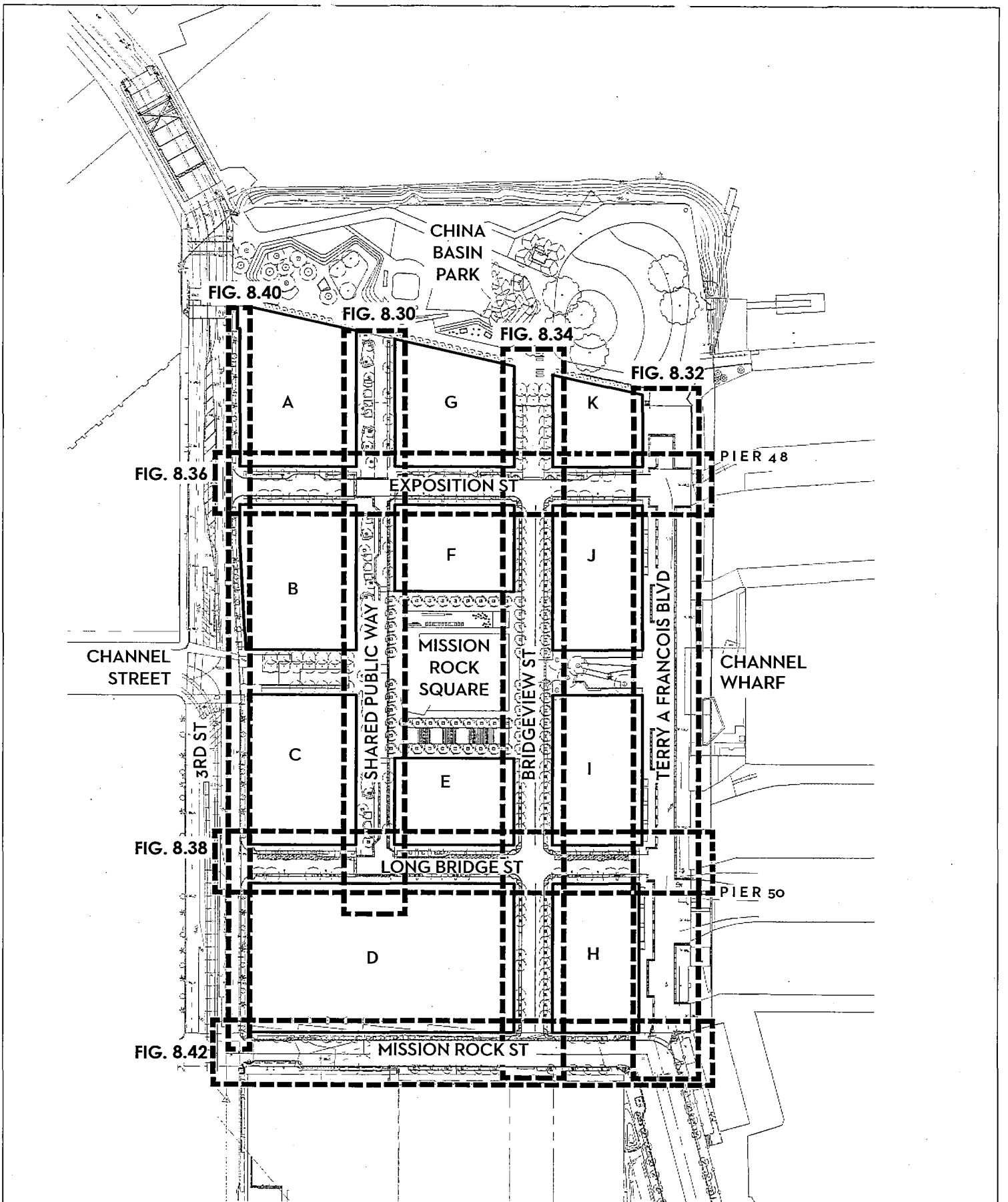

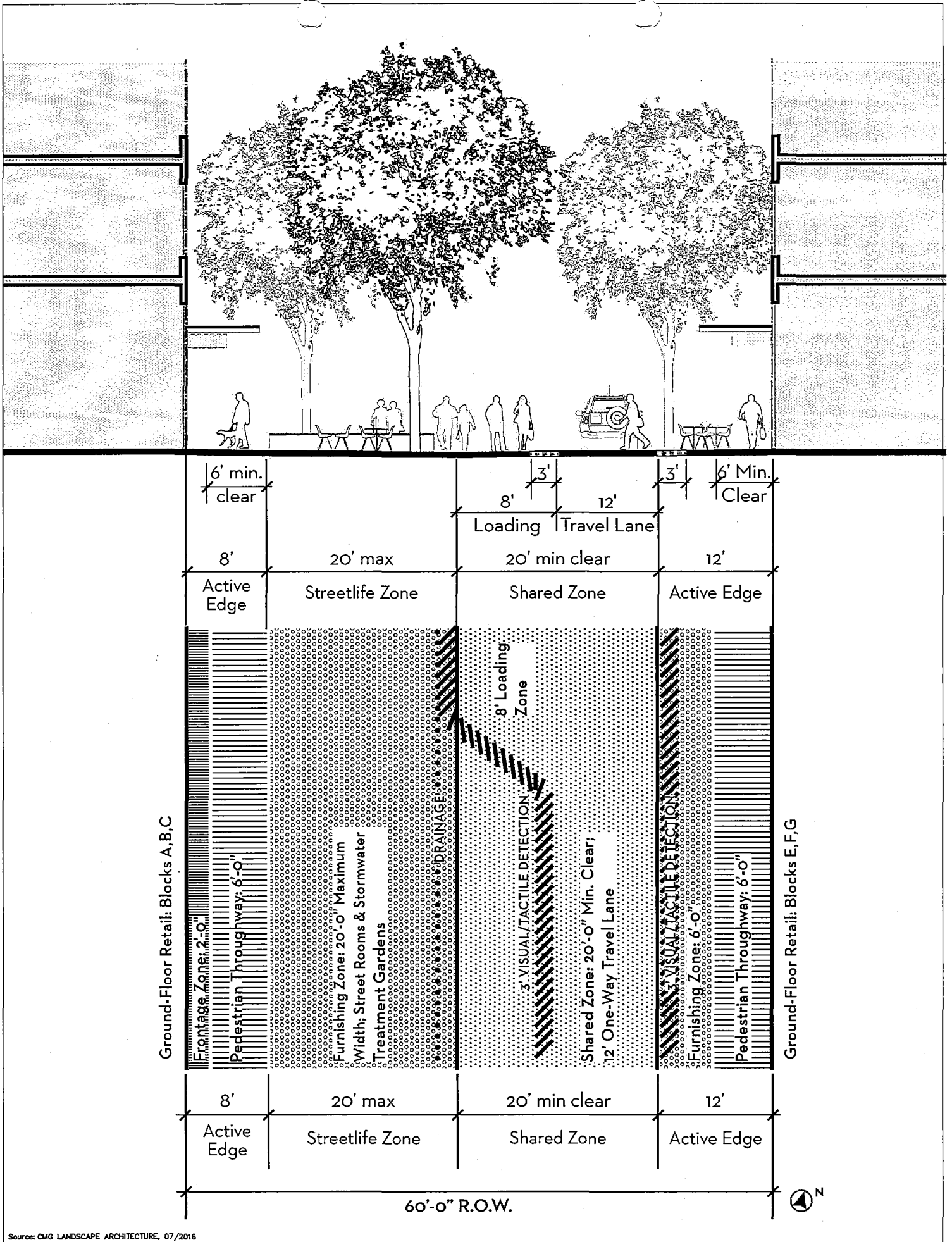

Source: CMG LANDSCAPE ARCHITECTURE, 07/2016

CHINA BASIN PARK

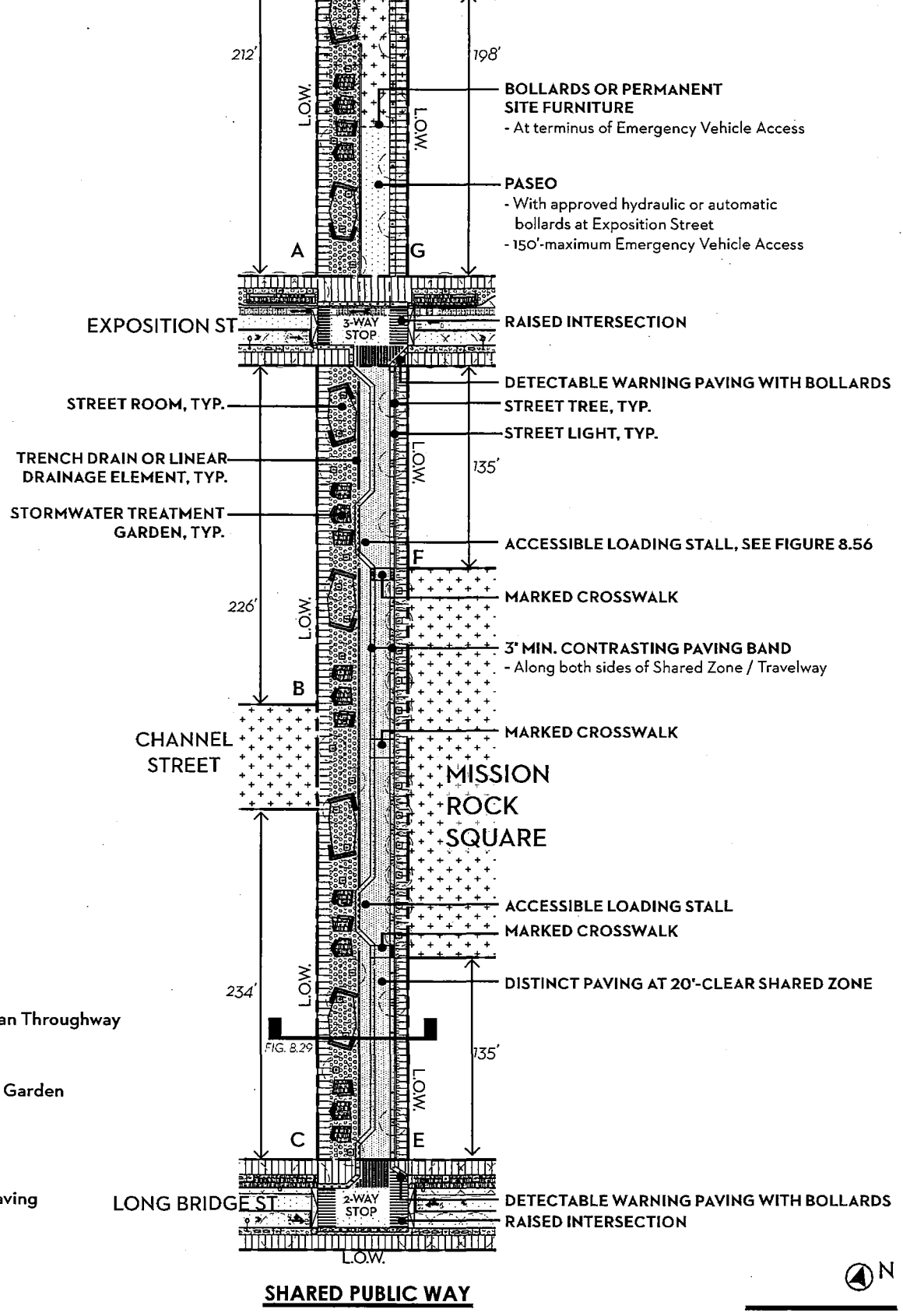

212'

LOW.

198'

LOW.

BOLLARDS OR PERMANENT SITE FURNITURE
- At terminus of Emergency Vehicle Access

PASEO
- With approved hydraulic or automatic bollards at Exposition Street
- 150'-maximum Emergency Vehicle Access

EXPOSITION ST

3-WAY STOP

RAISED INTERSECTION

STREET ROOM, TYP.

DETECTABLE WARNING PAVING WITH BOLLARDS
STREET TREE, TYP.
STREET LIGHT, TYP.

TRENCH DRAIN OR LINEAR DRAINAGE ELEMENT, TYP.

STORMWATER TREATMENT GARDEN, TYP.

LOW.

135'

ACCESSIBLE LOADING STALL, SEE FIGURE 8.56

226'

LOW.

MARKED CROSSWALK

3' MIN. CONTRASTING PAVING BAND
- Along both sides of Shared Zone / Travelway

CHANNEL STREET

MARKED CROSSWALK

MISSION ROCK SQUARE

ACCESSIBLE LOADING STALL
MARKED CROSSWALK

234'

LOW.

DISTINCT PAVING AT 20'-CLEAR SHARED ZONE

FIG. 8.29

135'

LOW.







LONG BRIDGE ST

2-WAY STOP

DETECTABLE WARNING PAVING WITH BOLLARDS
RAISED INTERSECTION

LOW.

SHARED PUBLIC WAY

-  Active Edge + Pedestrian Throughway
-  Streetlife Zone
-  Stormwater Treatment Garden
-  Shared Zone
-  Park / Open space
-  Detectable Warning Paving



0 100

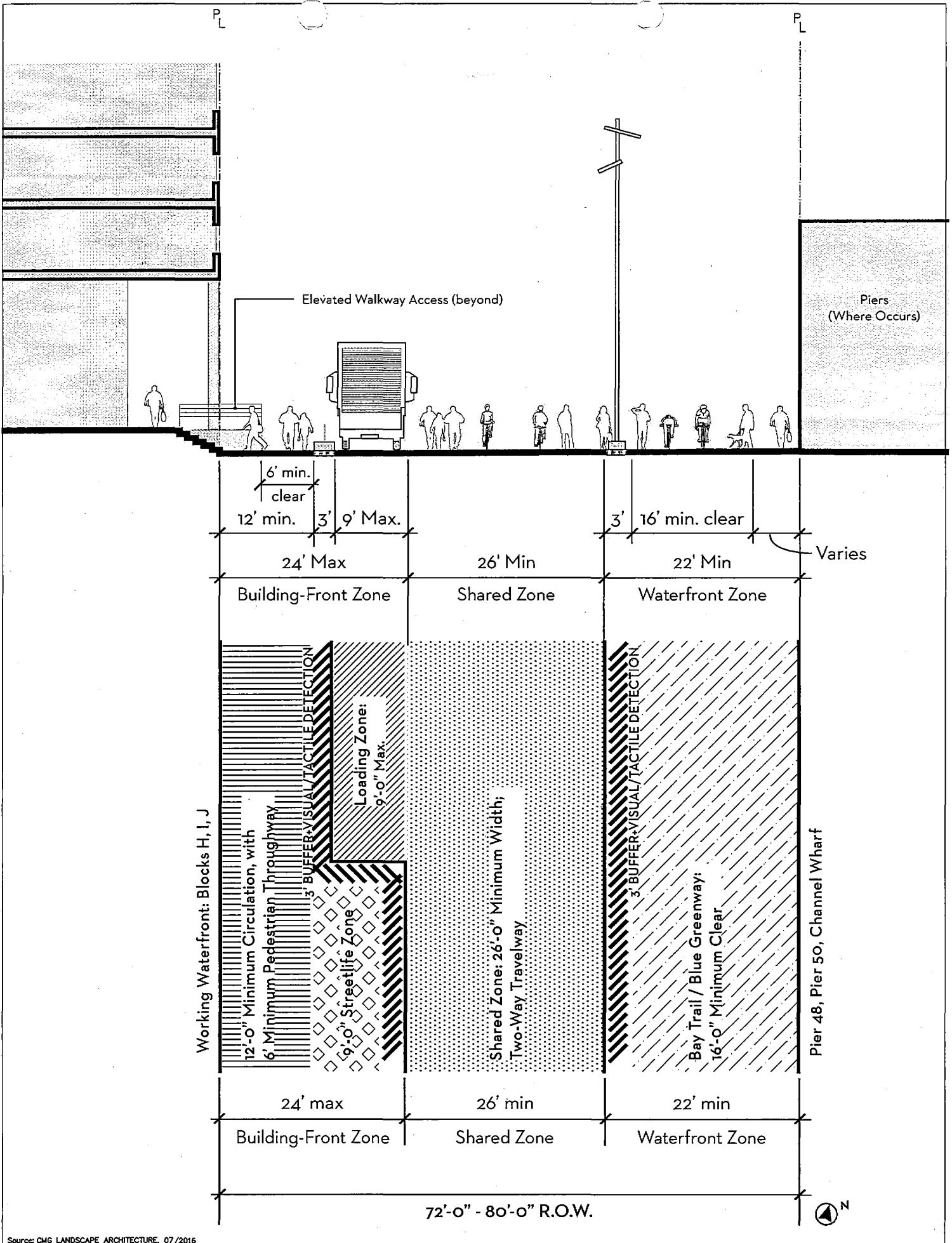

Source: CMG LANDSCAPE ARCHITECTURE, 07/2016

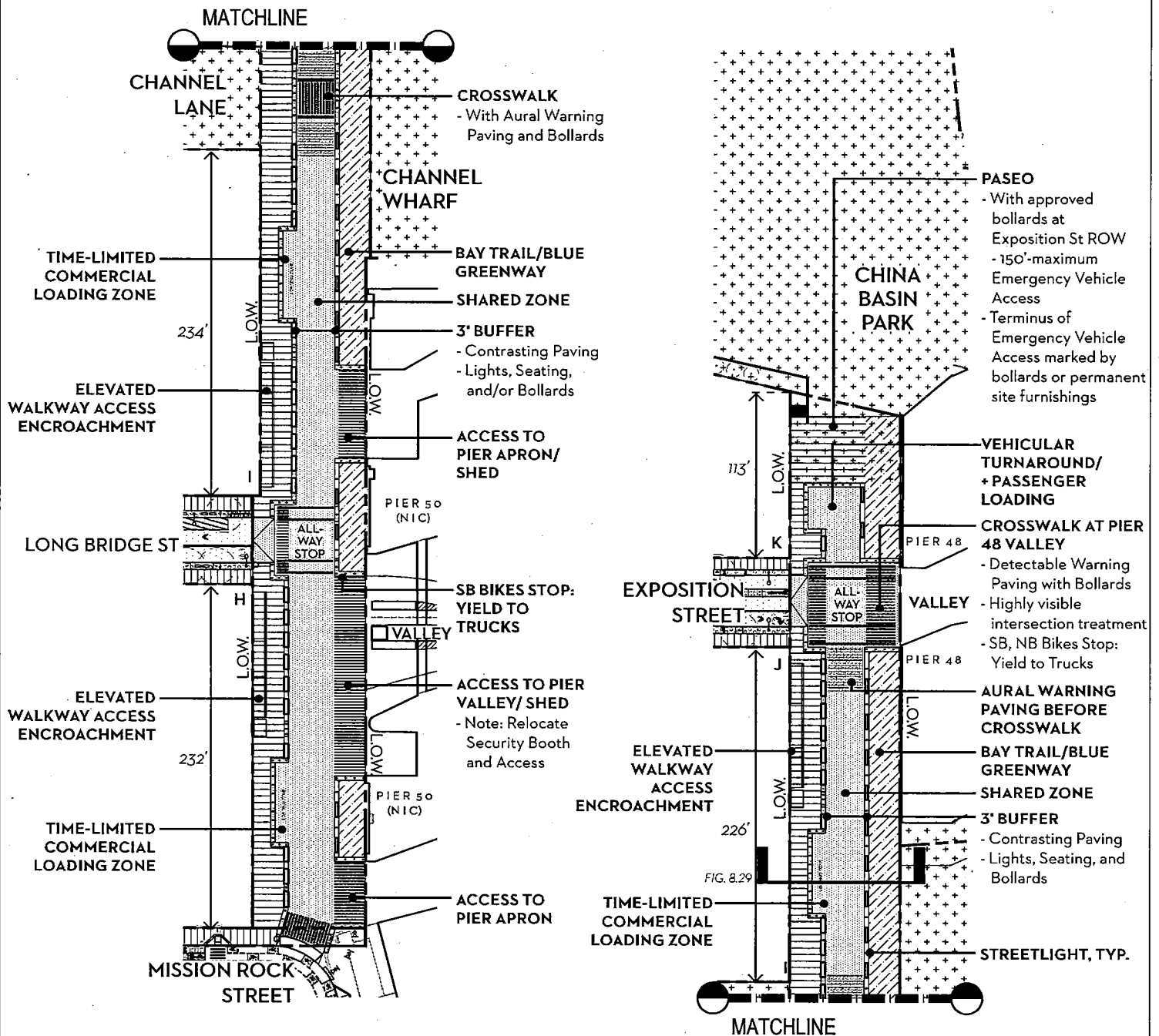

- Pedestrian Circulation + Throughway
- 3' Buffer (Tactile Warning + Bollards)
- Shared Zone
- Loading Zone
- Waterfront Zone
- Park / Open Space
- Detectable Warning Paving
- Aural Warning Paving

TERRY FRANCOIS BOULEVARD





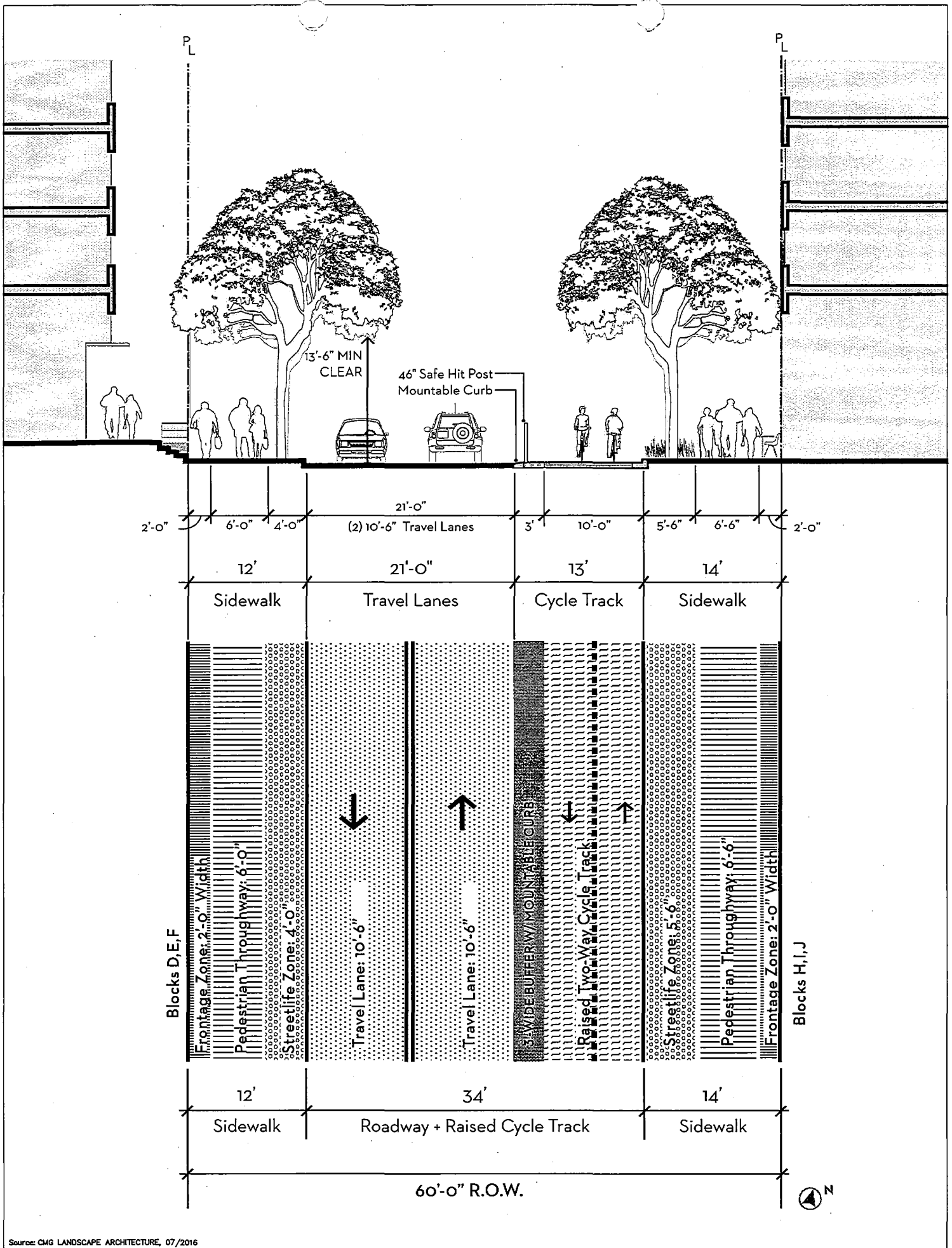

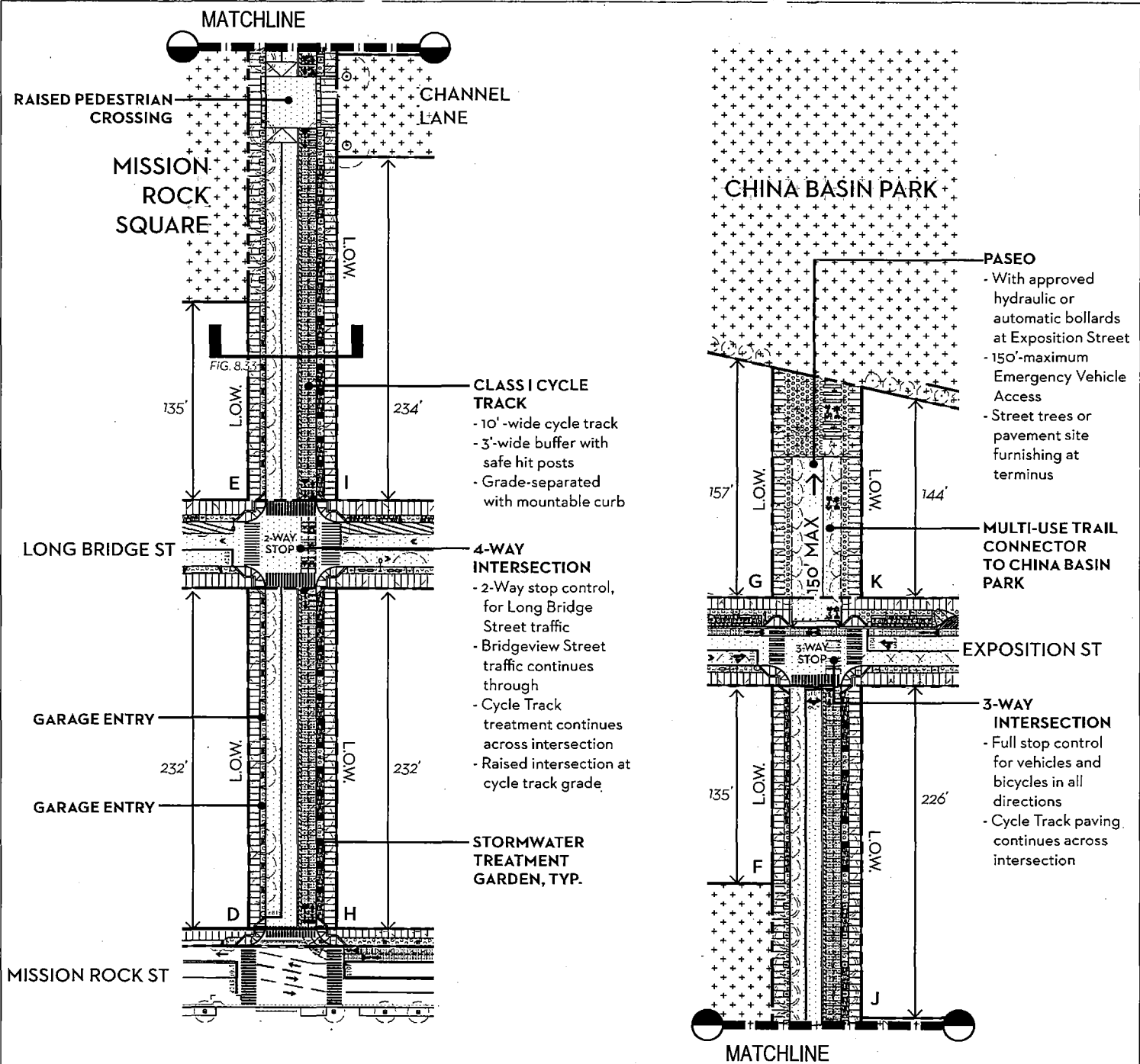

0 100



Source: CMG LANDSCAPE ARCHITECTURE, 07/2016



-  Active Edge + Pedestrian Throughway
-  Streetlife Zone
-  Stormwater Treatment Garden
-  Bike Lane / Cycle Track
-  Travel Lane
-  Detectable Warning Paving
-  Cycle Track Buffer

BRIDGEVIEW STREET



0 100

Source: CMG LANDSCAPE ARCHITECTURE, 07/2016

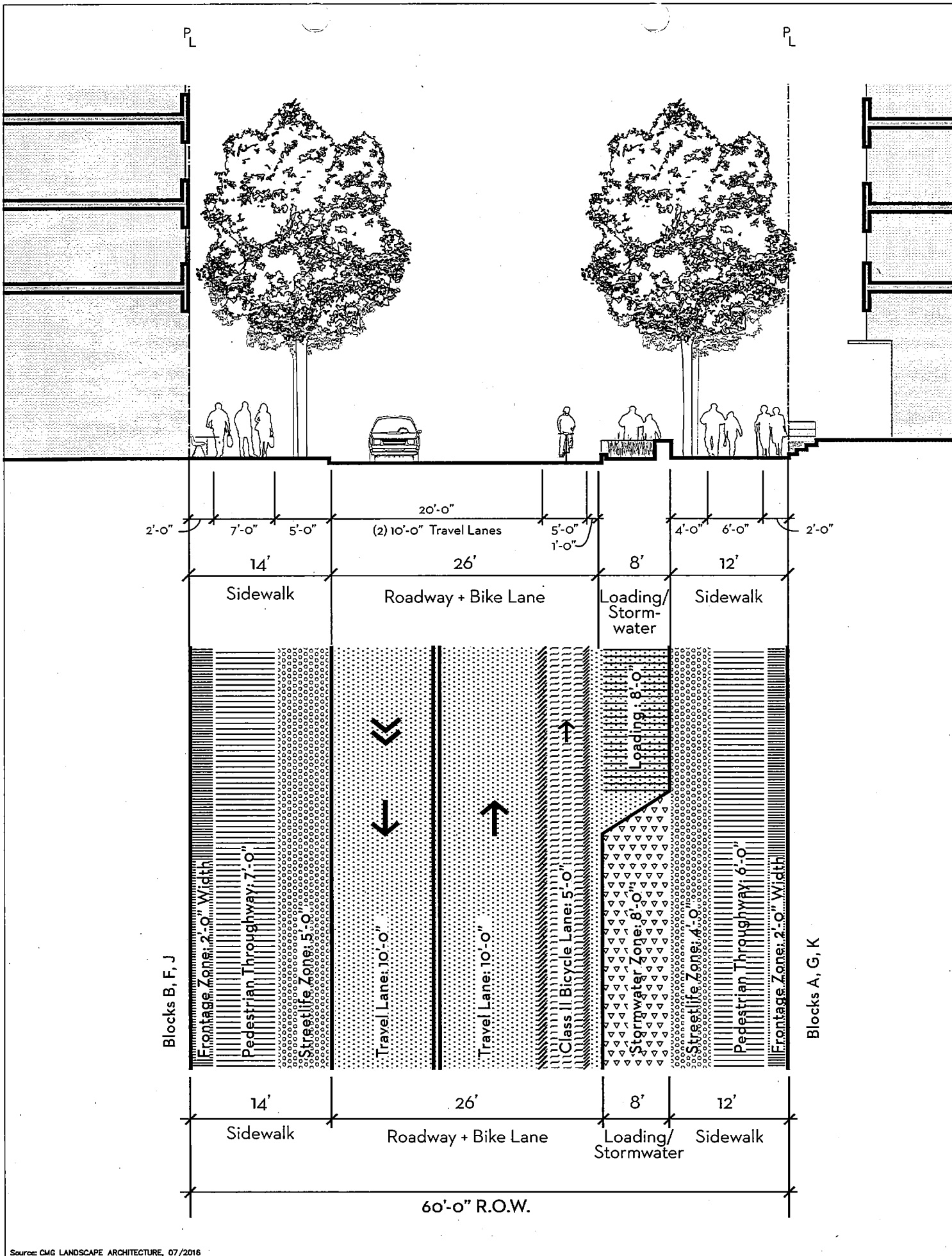

Source: CMG LANDSCAPE ARCHITECTURE, 07/2016

PIER 48

TERRY A FRANCOIS BLVD

COMMERCIAL LOADING/
SERVICING ZONE

ACCESSIBLE
LOADING STALL

LOW

LOW

BRIDGEVIEW STREET
CYCLE TRACK

BRIDGEVIEW
STREET

BRIDGEVIEW ST. PASEO
WITH MULTI-USE TRAIL

LOW

LOW

3-WAY INTERSECTION
- Full stop control for vehicles and
bicyclists in all directions
- Bike lane demarcation continues
across intersection

STORMWATER
TREATMENT BMP

ACCESSIBLE
LOADING STALL

COMMERCIAL LOADING/
SERVICING ZONE

LOW

LOW

186'

RAISED INTERSECTION

SHARED PUBLIC WAY
PASEO

LOW

LOW

SHARED
PUBLIC WAY

CLASS II BIKE LANE

COMMERCIAL LOADING/
SERVICING ZONE

STREETLIFE ZONE

LOW

LOW

181'









EAST-BOUND SHARROWS

STREET TREE, TYP.

STORMWATER TREATMENT GARDEN, TYP.
- Stormwater treatment in bulb-outs with
integral seating, typ.

STREETLIGHT, TYP.

3RD STREET

-  Active Edge + Pedestrian Throughway
-  Streetlife Zone
-  Stormwater Treatment Garden
-  Bike Lane / Cycle Track
-  Travel Lane
-  Loading Zone
-  Waterfront Zone
-  Detectable Warning Paving

EXPOSITION STREET



0 100

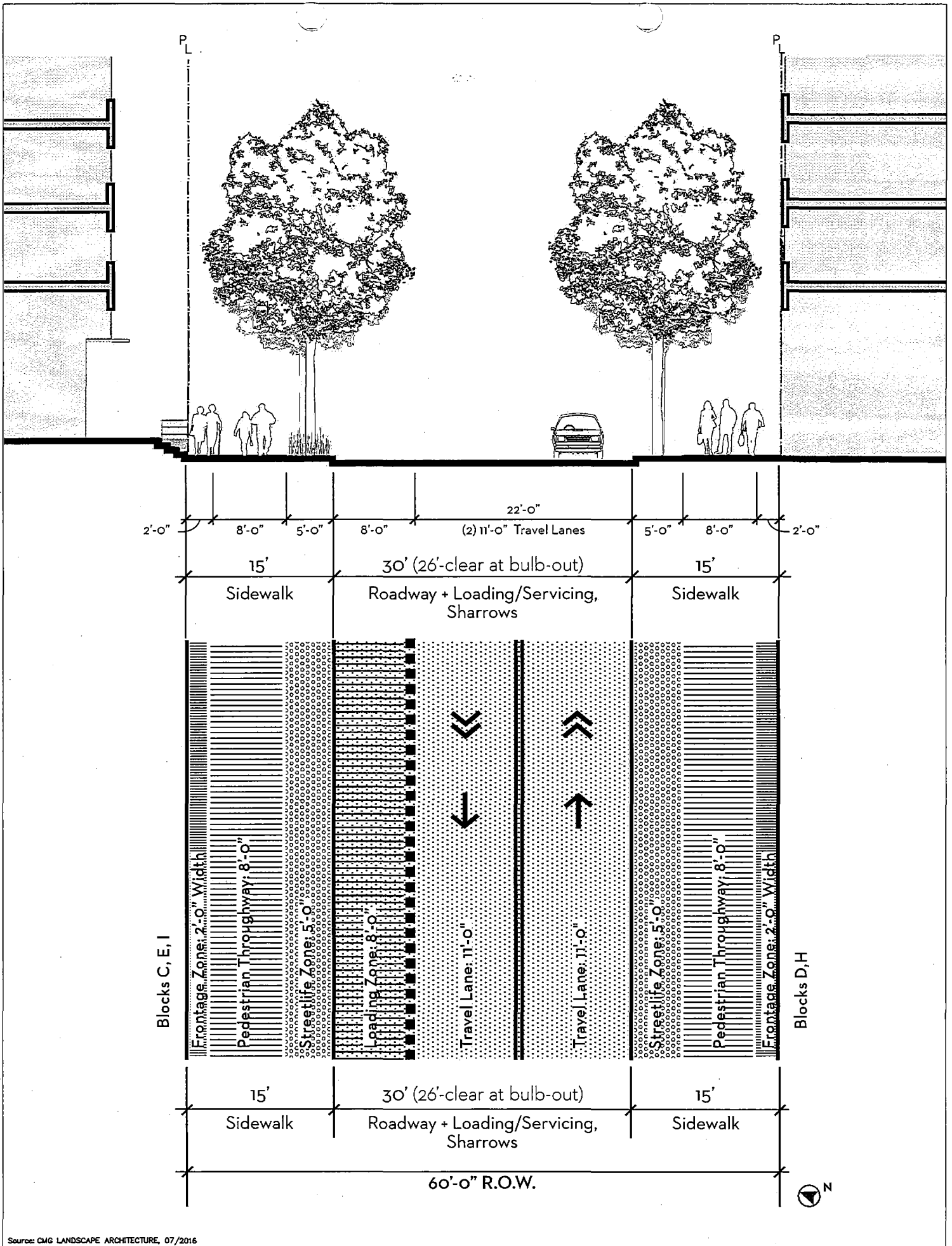

Source: CMG LANDSCAPE ARCHITECTURE, 07/2016

PIER 50
(NIC)

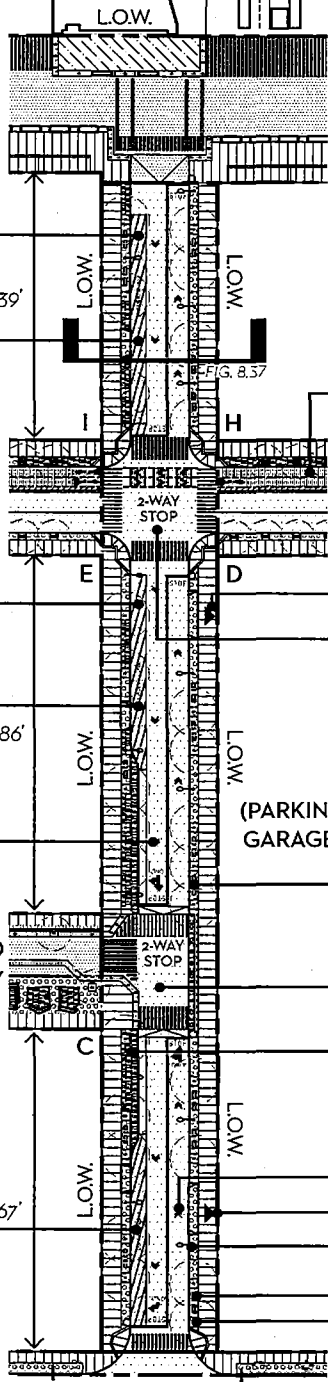

TERRY A FRANCOIS BLVD

ACCESSIBLE
LOADING STALL
139'

COMMERCIAL LOADING/
SERVICING ZONE

CYCLE TRACK

BRIDGEVIEW
STREET

ACCESSIBLE
LOADING STALL
186'

COMMERCIAL LOADING/
SERVICING ZONE

GARAGE EGRESS
4-WAY INTERSECTION
- Two-way stop control
(Long Bridge Street traffic stops)
- Cycle Track treatment continues across intersection
- Raised Intersection at cycle track grade

WEST-BOUND SHARROWS

(PARKING
GARAGE)

STREETLIFE ZONE

SHARED
PUBLIC WAY

RAISED INTERSECTION







STORMWATER TREATMENT GARDEN
- Within bulb-out

COMMERCIAL LOADING/
SERVICING ZONE
167'

EAST-BOUND SHARROWS
GARAGE INGRESS
STREET LIGHT, TYP.
SEATING, TYP.
STREET TREE, TYP.

3RD STREET

LONG BRIDGE STREET

-  Active Edge + Pedestrian Throughway
-  Streetlife Zone
-  Stormwater Treatment Garden
-  Travel Lane
-  Loading Zone
-  Waterfront Zone
-  Detectable Warning Paving



0 100

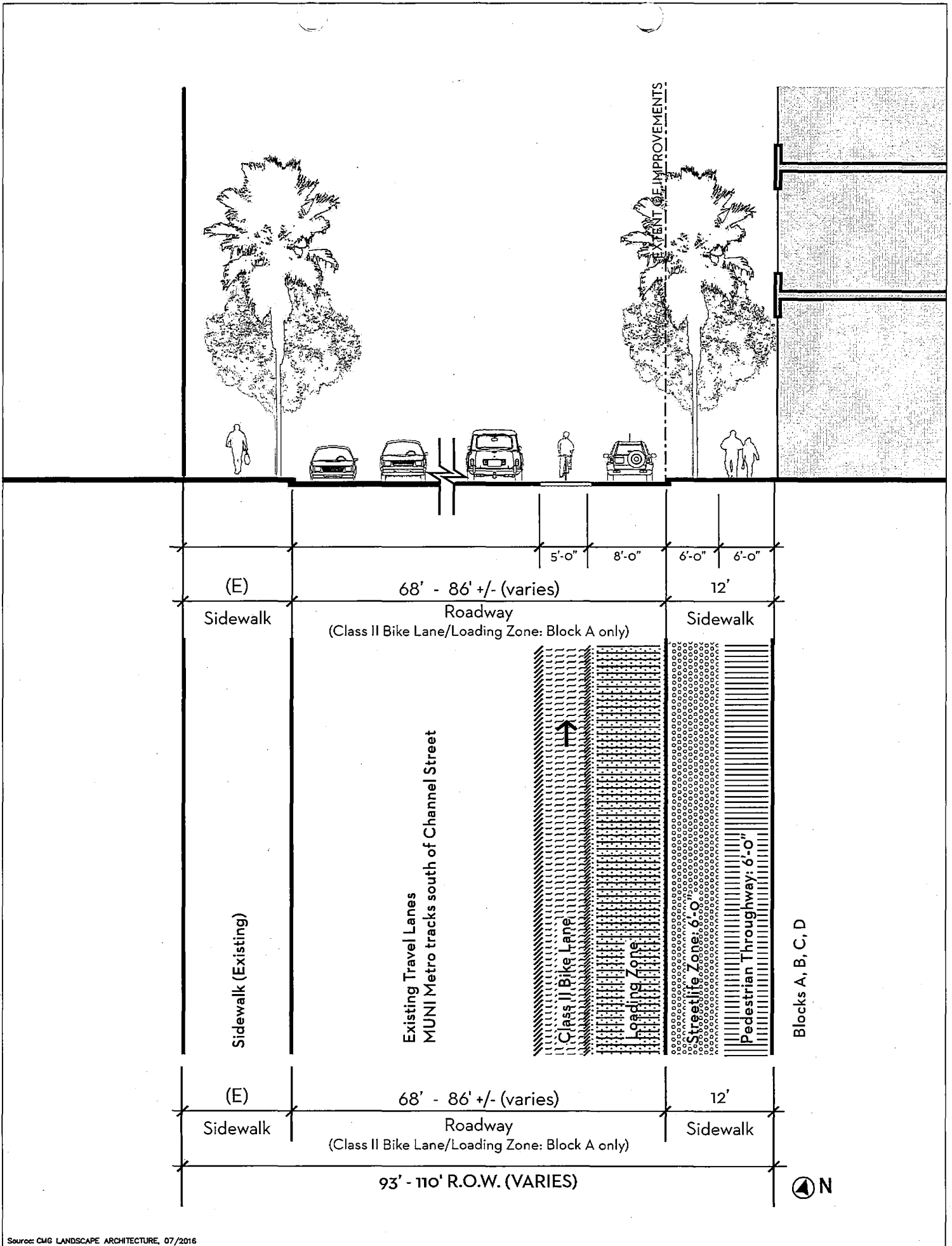



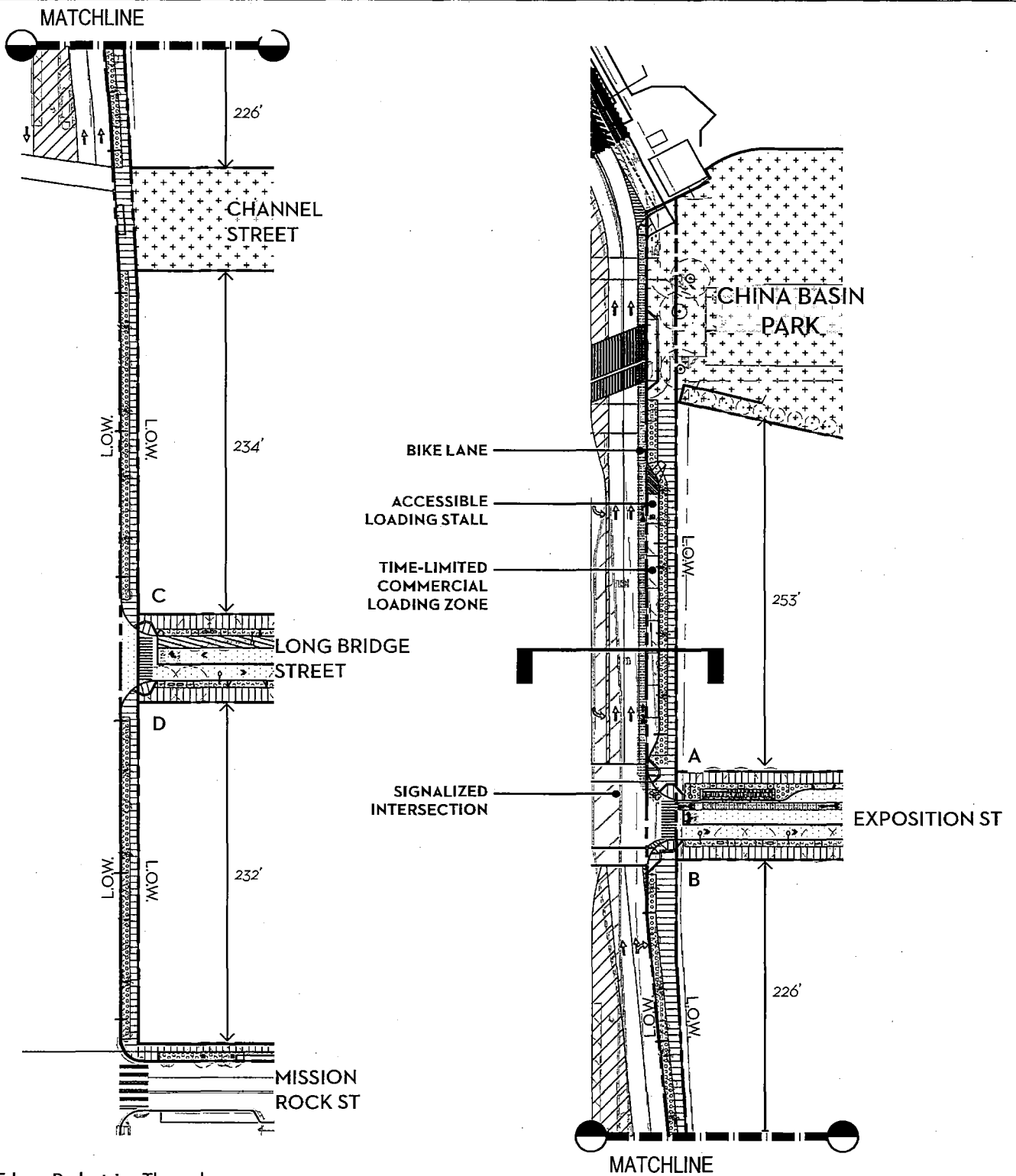

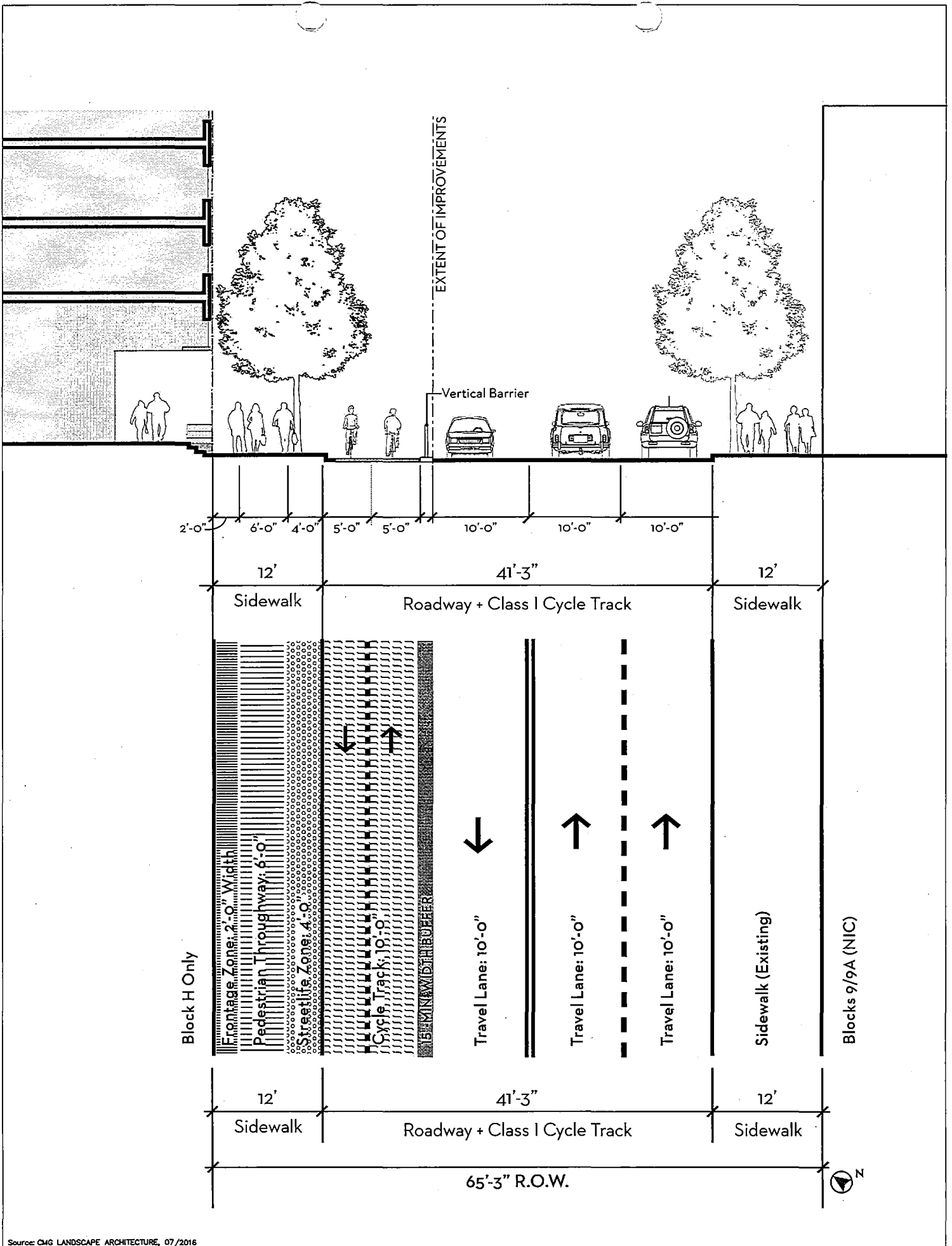

Source: CMG LANDSCAPE ARCHITECTURE, 07/2016

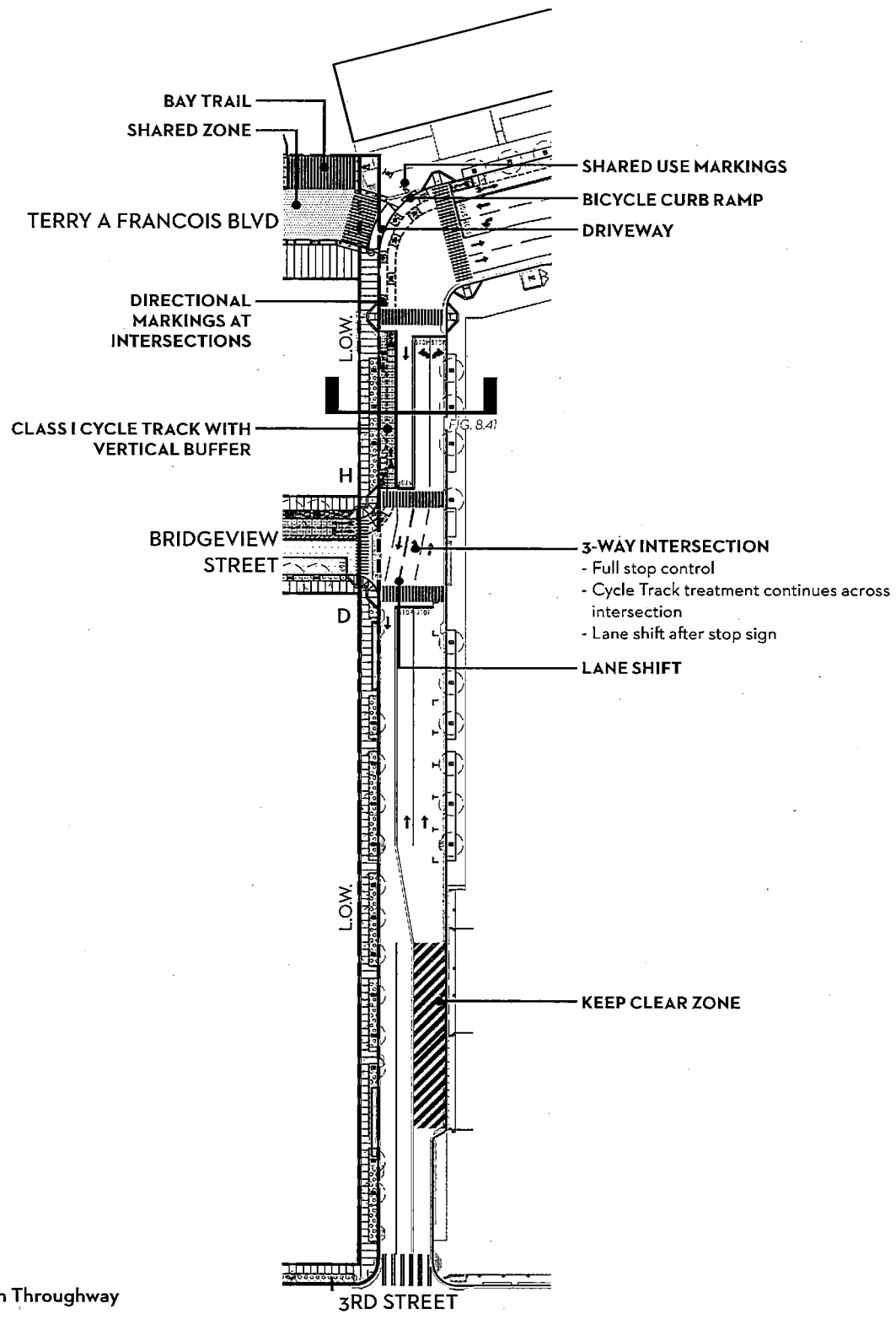

THIRD STREET





-  Active Edge + Pedestrian Throughway
-  Furnishing Zone
-  Bike Lane / Cycle Track
-  Travel Lane
-  Detectable Warning Paving

MISSION ROCK STREET



0 100

DRAWING NAME: \\BKF-SF\va\4\2008\080006_Mission_Rock\EMC\Exhibits\Infrastructure_Plan_Exhibits\Plotted_Sheets\Figure 8.43 Curb Heights Plan.dwg
 PLOT DATE: 07-13-17
 PLOTTED BY: FEL
 Source: BKF ENGINEERS, 07/2016

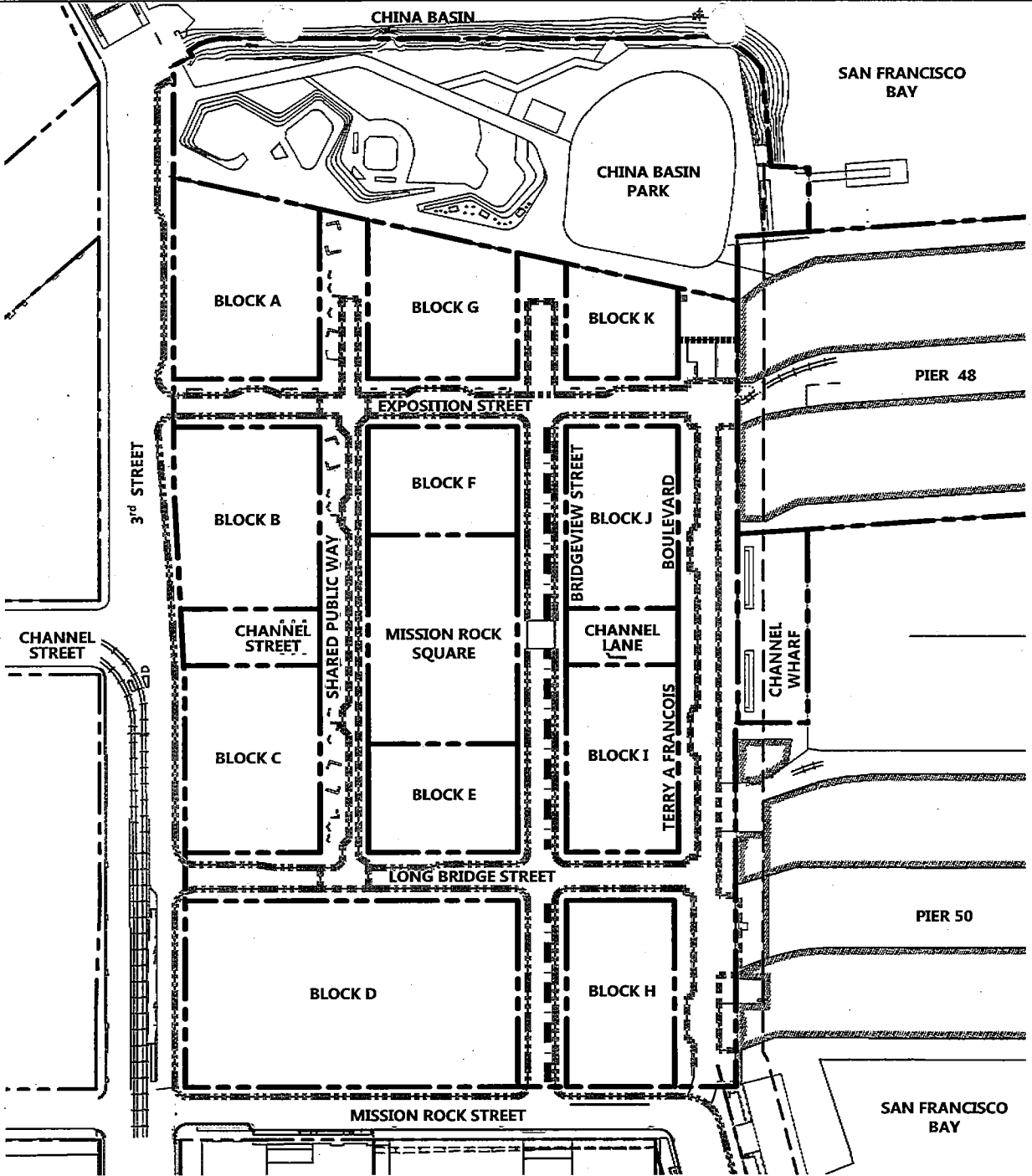

- LEGEND**
- — — — — PROPOSED PARCEL LINE
 - — — — — EXISTING PARCEL LINE
 - — — — — FLUSH CURB OR CURBLESS
 - — — — — 6" CURB
 - — — — — 6" CURB & GUTTER
 - — — — — MOUNTABLE CURB AT CYCLE TRACK

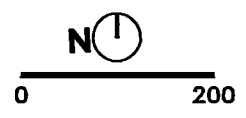

FIGURE 8.44: PAVING DIAGRAM

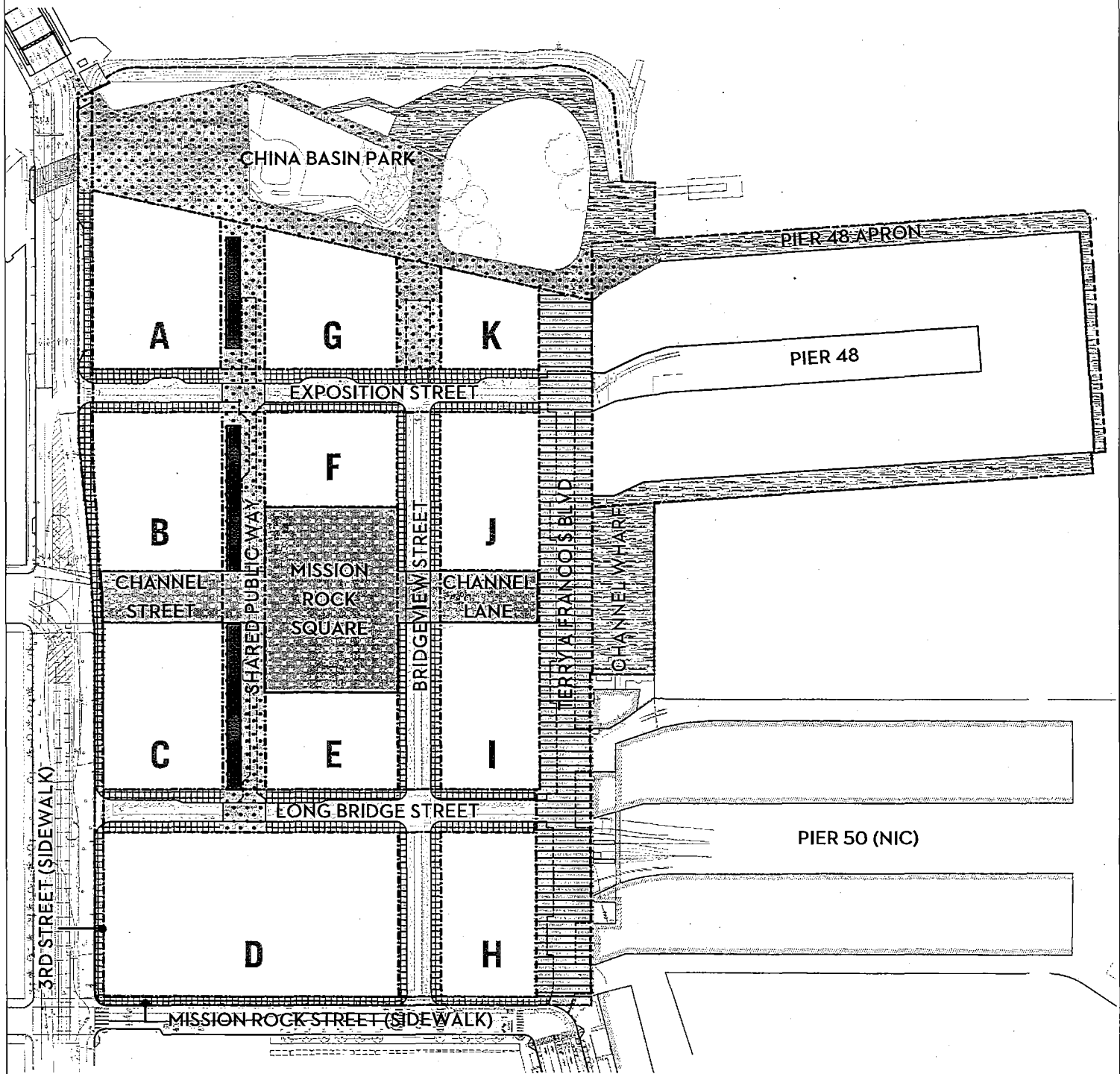

FIGURE 8.44: PAVING DIAGRAM (OPEN SPACES SHOWN FOR REFERENCE)



- | | | | |
|--|---|--|--|
| | Sidewalk (DPW-Standard) | | Open Space: Mission Rock Square, Channel Street + Channel Lane |
| | Working Waterfront Paving: Terry Francois Blvd. (Non-DPW-Standard) | | Open Space: Waterfront Paving |
| | Pedestrian-Scale Paving: Shared Public Way, Paseos + Open Spaces (Non-DPW-Standard) | | Proposed Boundary |
| | Special Paving (Non-DPW-Standard) | | |

Source: CMG LANDSCAPE ARCHITECTURE, 07/2016

FIGURE 8.45: PAVING ZONES BY STREET

SHARED PUBLIC WAY		
PAVING	STREET ZONE	DESCRIPTION
Active Edge	Pedestrian Throughway	Pedestrian Unit Pavers, with approved tree pit surfacing at trees.
	Furnishing Zone	
	Frontage Zone	
	Buffer at Shared Zone	Detectable Surface Paving: Alternate (non-DPW-Standard) tactile paving, with 70% visual contrast from adjacent paving and textured surface.
Streetlife Zone	Furnishing Zone	Pedestrian Unit Pavers, with approved tree pit surfacing at trees and special paving street rooms.
	Buffer at Shared Zone	Detectable Surface Paving: Alternate (non-DPW-Standard) tactile paving, with 70% visual contrast from adjacent paving and textured surface.
Shared Zone	Vehicular Travelway	Vehicular Unit Pavers
	Loading Zones	Vehicular Unit Pavers, with color contrast.
	Crosswalks	Textured Paving, contrasting from adjacent surfaces, with DPW-Standard detectable paving.
CURBS AND DRAINAGE		
Curb at Shared Zone		Curbless
Trench Drain		6" - 12" wide trench drain/linear drainage element, located outside of vehicular travelway.
TERRY A FRANCOIS BOULEVARD		
PAVING	STREET ZONE	DESCRIPTION
Building-Front Zone	Pedestrian Throughway	Pedestrian Unit Pavers or CIP Concrete Paving
	Streetlife Zone	
	Loading Zones	Vehicular Unit Pavers or CIP Concrete Paving.
	Buffer at Shared Zone	Detectable Surface Paving: Alternate (non-DPW-Standard) tactile paving, with 70% visual contrast from adjacent paving and textured surface.
Waterfront Zone	Blue Greenway	Pedestrian Unit Pavers or CIP Concrete Paving
	Buffer at Shared Zone	Detectable Surface Paving: Alternate (non-DPW-Standard) tactile paving, with 70% visual contrast from adjacent paving and textured surface.
Shared Zone	Vehicular Travelway	Vehicular Unit Pavers or CIP Concrete Paving
	Crosswalks	Textured Paving, contrasting from adjacent surfaces, with DPW-Standard detectable paving.
CURBS AND DRAINAGE		
Curb at Shared Zone		CIP Concrete Flush Curb
Trench Drain		6" - 12" wide Trench Drain, located outside of vehicular travelway.
BRIDGEVIEW STREET		
PAVING	STREET ZONE	DESCRIPTION
Sidewalk	Frontage Zone	DPW-Standard CIP Concrete or Pedestrian Unit Pavers
	Pedestrian Throughway	DPW-Standard CIP Concrete
	Streetlife Zone	Pedestrian Unit Pavers, with approved tree pit surfacing at trees.
Roadway	Raised Cycle Track	Painted Asphalt with contrasting buffer
	Travel Lanes	DPW-Standard Asphalt Concrete Paving
CURBS AND DRAINAGE		
Curb + Gutter, West Side		DPW-Standard, 6" Curb typical
Curb + Gutter, East Side		Non-DPW Standard 4" Vertical Curb
Curb at Raised Cycle Track		Mountable Curb

Source: CMG LANDSCAPE ARCHITECTURE, 07/2016

FIGURE 8.46: PAVING ZONES BY STREET

EXPOSITION STREET		
PAVING	STREET ZONE	DESCRIPTION
Sidewalk	Frontage Zone	DPW-Standard CIP Concrete or Pedestrian Unit Pavers
	Pedestrian Throughway	DPW-Standard CIP Concrete
	Streetlife Zone	Pedestrian Unit Pavers, with approved tree pit surfacing at trees
	Stormwater Treatment	Custom/Feature Flow-Through Planters with Understory Planting
Roadway	Travel Lanes	DPW-Standard Asphalt Concrete Paving
	Class II Bicycle Lane	Painted DPW-Standard Asphalt Concrete Paving
	Loading	DPW-Standard Asphalt Concrete Paving
CURBS AND DRAINAGE		
Curb + Gutter		DPW-Standard, 6" Curb typical
LONG BRIDGE STREET		
PAVING	STREET ZONE	DESCRIPTION
Sidewalk	Frontage Zone	DPW-Standard CIP Concrete or Pedestrian Unit Pavers
	Pedestrian Throughway	DPW-Standard CIP Concrete
	Streetlife Zone	Pedestrian Unit Pavers, with approved tree pit surfacing at trees
Roadway	Loading Zone	Painted DPW-Standard Asphalt Concrete Paving
	Travel Lanes	DPW-Standard Asphalt Concrete Paving
CURBS AND DRAINAGE		
Curb + Gutter		DPW-Standard, 6" Curb typical
MISSION ROCK STREET		
PAVING	STREET ZONE	DESCRIPTION
Sidewalk	Pedestrian Throughway	OCII / Mission Bay Standard CIP Concrete.
	Streetlife Zone	OCII / Mission Bay Standard Pedestrian Unit Pavers, with approved tree pit surfacing at trees
Roadway	Cycle Track	Painted Asphalt Concrete Paving
	Travel Lanes	DPW-Standard Asphalt Concrete Paving
CURBS AND DRAINAGE		
Curb + Gutter		DPW-Standard, 6" Curb typical. OCII / Mission Bay Standard
Raised Buffer at Cycle Track		6" high x 15" minimum width buffer, segmented to facilitate drainage
3 RD STREET		
PAVING	STREET ZONE	DESCRIPTION
Sidewalk	Pedestrian Throughway	OCII / Mission Bay Standard CIP Concrete
	Streetlife Zone	OCII / Mission Bay Standard paving and approved tree pit surfacing at trees

Source: CMG LANDSCAPE ARCHITECTURE, 07/2016

FIGURE 8.47: URBAN FOREST

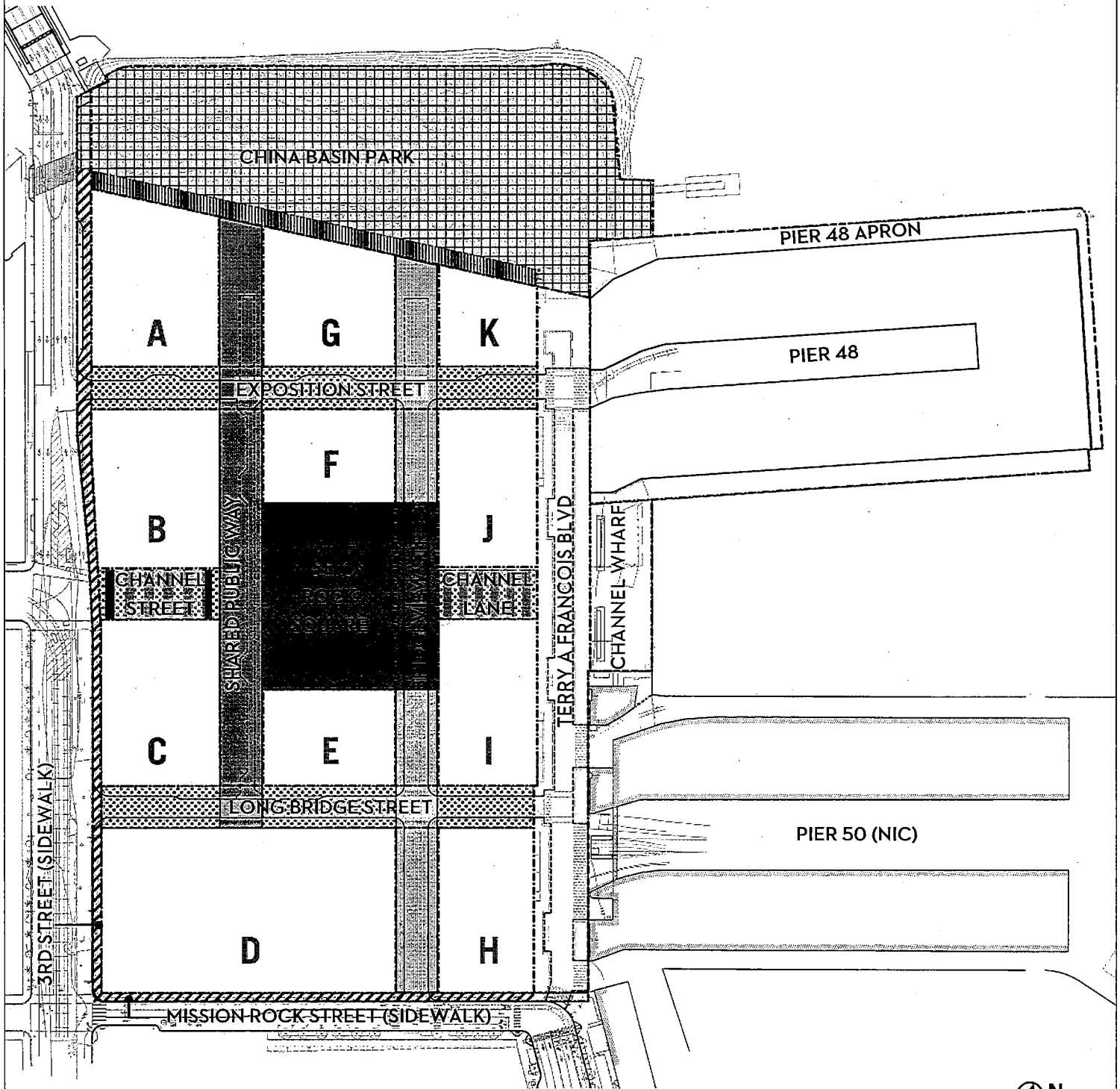









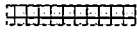

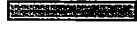

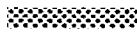

FIGURE 8.47: URBAN FOREST DIAGRAM (OPEN SPACES SHOWN FOR REFERENCE)



- | | |
|---|--|
| <ul style="list-style-type: none">  China Basin Park
- Large, iconic specimen evergreen trees  Park Promenade
- Small to medium tree with upright habit, shade tolerance required  Shared Public Way
- Large, arching trees with fine-textured canopy  Mission Rock Square
- Large, uniform, upright trees with iconic seasonal character in leaf or flower | <ul style="list-style-type: none">  Neighborhood Street Tree: Upright
- Medium to large tree with upright habit  Neighborhood Street Tree: Arching
- Medium to large tree with arching habit, special seasonal character  Channel St and Channel Lane
- Wind-tolerant tree from Mission Rock Square, Neighborhood Street palettes  Mission Bay Street Trees
- Per OCII Mission Bay Standards |
|---|--|

Source: CMG LANDSCAPE ARCHITECTURE, 07/2016

FIGURE 8.48: URBAN FOREST DESIGN CRITERIA

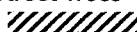
TREE TYPE	SIZE	TOLERANCES	WATER USE	DESIGN CRITERIA	RECOMMENDED SPECIES
China Basin Park: Specimen Tree 	At Installation: Min. 48" Box At Maturity: 50' x 60' (HxW)	Wind: High ----- Shade: Partial Shade	Low to Medium	<ul style="list-style-type: none"> • Iconic character • Windbreak • Healthy in paving and/or lawn • Coastal tolerance 	Monterey Cypress [<i>Cupressus macrocarpa</i>] New Zealand Christmas Tree [<i>Metrosiderous excelsa</i>] Red-Flowering Gum [<i>Corymbia ficifolia</i>]
China Basin Park: Park Promenade 	At Installation: Min. 48" Box At Maturity: 30' x 35' (H)	Wind: Medium-High ----- Shade: Deep Shade	Low	<ul style="list-style-type: none"> • Scaled to intimating walking experience • Ornamental leaves, flowers, bark • Paving tolerant • Coastal tolerance 	Red Oak cultivar [<i>Quercus rubra</i> 'Crimson Spire'] Melaleuca [<i>Melaleuca quinquenervia</i>]
Shared Public Way 	At Installation: Min 48" Box At Maturity: 45'-50' (H)	Wind: High ----- Shade: Partial Shade	Low	<ul style="list-style-type: none"> • Fine textured canopy • Trunk 13'-6" clear from paving • 48" box min 	Chinese Elm [<i>Ulmus parvifolia</i>] Strawberry Tree [<i>Arbutus 'Marina'</i>] Southern Live Oak [<i>Quercus virginiana</i>]
Mission Rock Square 	At Installation: Min 48" Box At Maturity: 45'-50' (H)	Wind: Medium ----- Shade: Partial to Full Shade	Low	<ul style="list-style-type: none"> • Medium-Fine textured canopy • Winter/Summer interest • Trunk 8' clear from paving • 48" box min 	Ginkgo [<i>Ginkgo biloba</i> cultivar] Freeman Maple [<i>Acer x. freemanii</i>] Chinese Elm [<i>Ulmus parvifolia</i>]
Neighborhood Street: Upright 	At Installation: Min 48" Box At Maturity: 40' (H)	Wind: Medium ----- Shade: Partial to Full Shade	Low	<ul style="list-style-type: none"> • Winter/Summer interest • Trunk 13'-6" clear from paving/ travel lanes 	Brisbane Box [<i>Lophostemon confertus</i>] Red Oak cultivar [<i>Quercus rubra</i> 'Crimson Spire']
Neighborhood Street: Arching 	At Installation: Min 48" Box At Maturity: 35'-40' (H)	Wind: Medium ----- Shade: Partial Shade	Low	<ul style="list-style-type: none"> • Special flowering • Trunk 13'-6" clear from paving/ travel lanes 	Victorian Box [<i>Pittosporum undulatum</i>] California Pepper [<i>Schinus molle</i>] Cork Oak [<i>Quercus suber</i>]
Channel Street / Channel Lane 	See description for: Mission Rock Square and/or Neighborhood Street Tree: Upright				
Mission Bay Street Trees 	Per OCII / Mission Bay Standards				

Source: CMG LANDSCAPE ARCHITECTURE, 07/2016

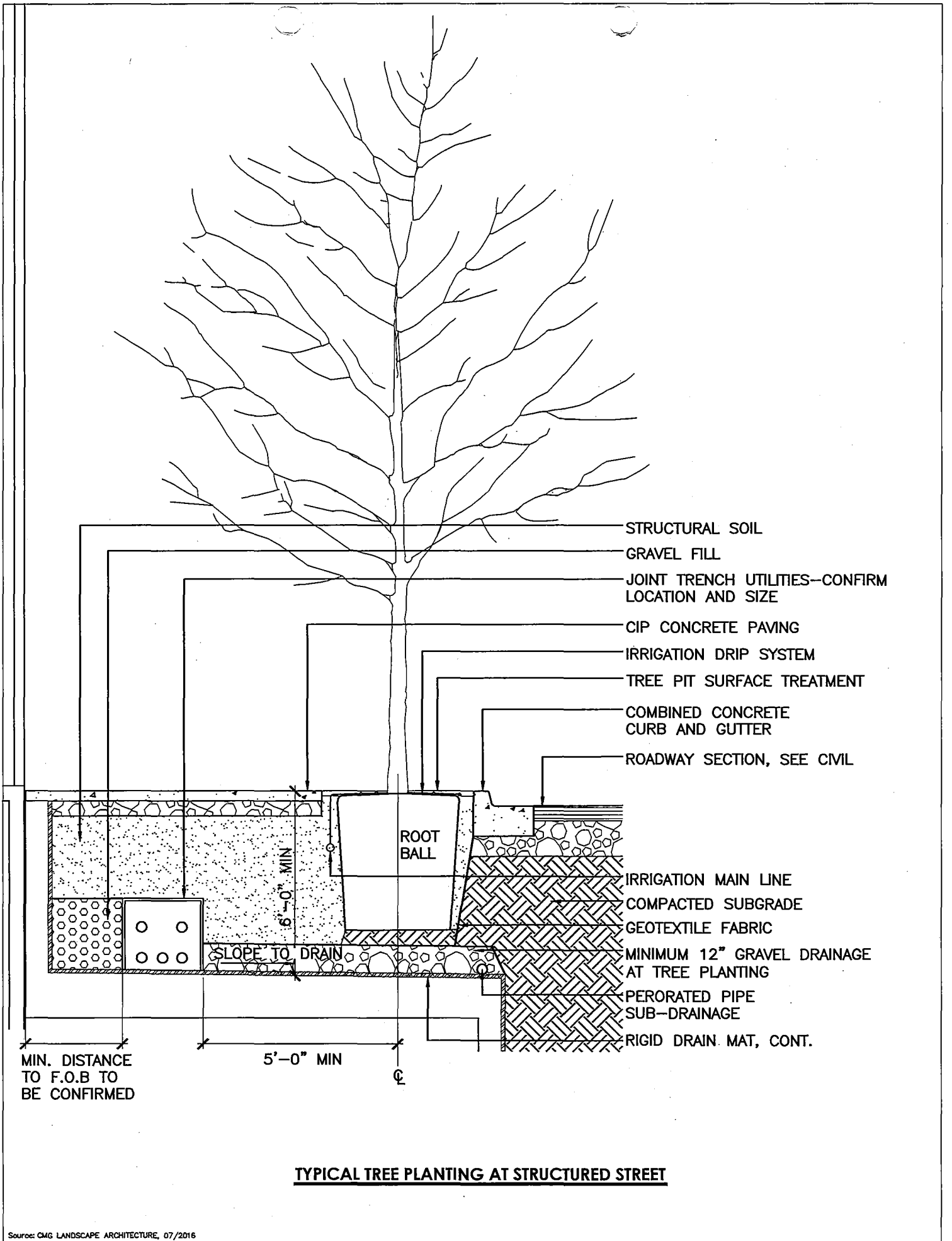

TYPICAL TREE PLANTING AT STRUCTURED STREET

FIGURE 8.50: STORMWATER TREATMENT CONCEPTUAL DIAGRAM

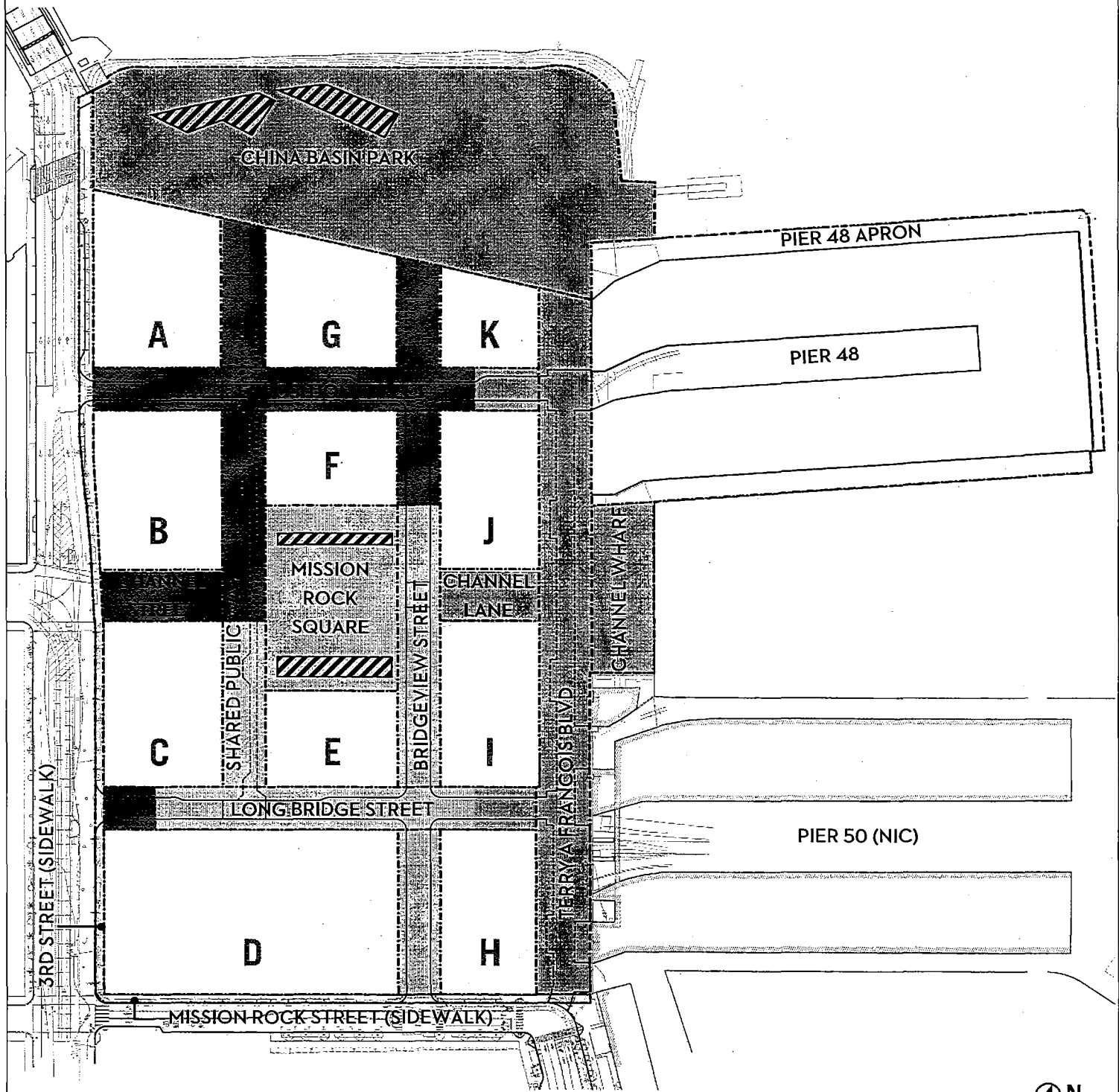
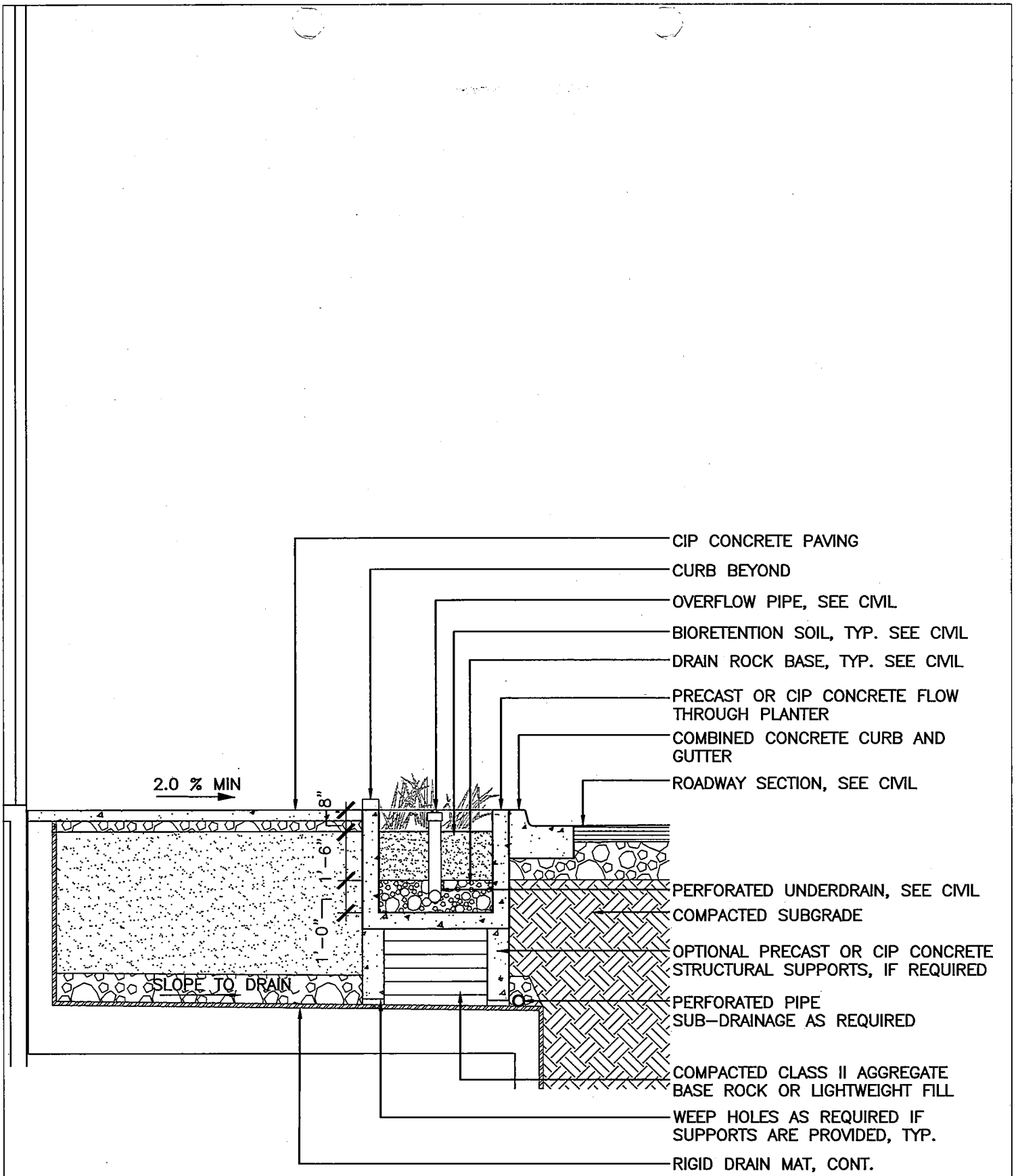

FIGURE 8.50: STORMWATER TREATMENT CONCEPTUAL DIAGRAM

- Localized Treatment
- Large Feature Stormwater Gardens
- Centralized Treatment: Mission Rock Square
- Open Space (Shown for reference only)
- Centralized Treatment: China Basin Park

Source: CMG LANDSCAPE ARCHITECTURE, 07/2016



TYPICAL STORMWATER FLOW THROUGH PLANTER

FIGURE 8.52: LIGHTING DIAGRAM

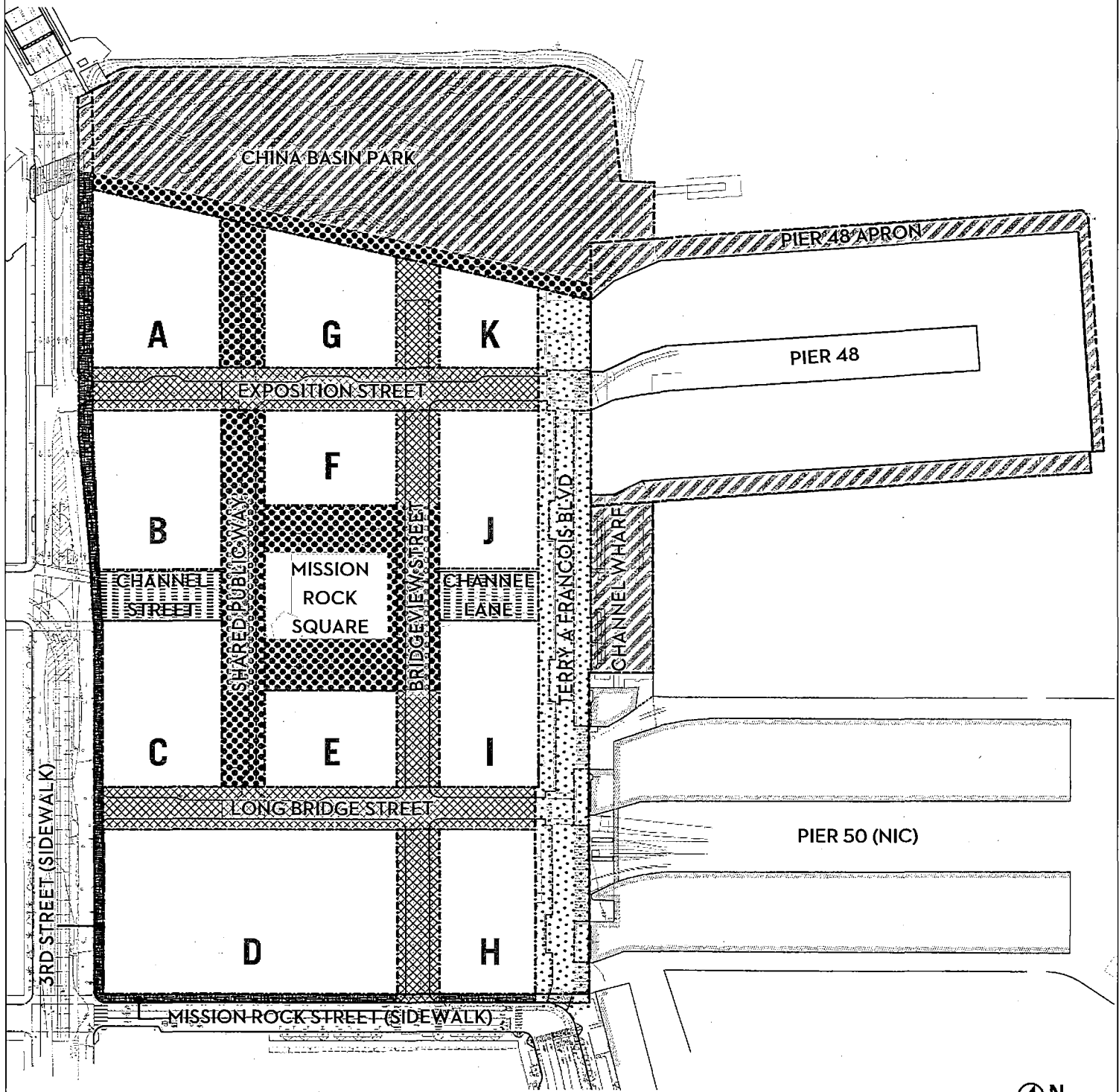

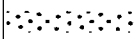

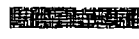



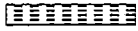



FIGURE 16: LIGHTING DIAGRAM (OPEN SPACES SHOWN FOR REFERENCE)

- 
Zone 1: Waterfront
 - Light levels should be brightest at the buildings, and less bright at the waterfront to minimize impact on the ecosystem at the water's edge.
- 
Zone 2: High-Activity, High Retail
 - Opportunity for feature lighting; variety of light types encouraged; contributing ambient light from ground floor uses.
- 
Zone 3: Working-Waterfront
 - Iconic lighting; intersections should be highly visible.
- 
Zone 4: Neighborhood Streets
 - Some contributing light from ground-floor uses, especially on Bridgeview Street; intersection should be highly visible.
- 
Zone 5: Gateways
 - Opportunity for overhead lighting.
- 
Zone 6: District Streets
 - Mission Bay. Refer to OCII Mission Bay controls.

Source: CMG LANDSCAPE ARCHITECTURE, 07/2016

FIGURE 8.53: LIGHTING ZONES

LIGHTING ZONE	LIGHTING ZONE DESCRIPTION	PEDESTRIAN LIGHT LEVELS (FOOTCANDLES)*	ROADWAY MINIMUM MAINTAINED AVERAGE LIGHT LEVEL (fc)*	UNIFORMITY RATIO, AVERAGE / MINIMUM*
Zone 1: Waterfront	<i>Light levels should be brightest at the buildings, and less bright at the waterfront to minimize impact on the ecosystem at the water's edge.</i>			
	Non-Waterfront Paths	1 fc Average	N/A	10:1
	Planting/Lawn Areas	0.5-0.8 fc Average	N/A	40:1
	Plaza/Wharf Areas	0.8-1 fc Average	N/A	20:1
	Waterfront Paths	0.5-0.8 fc Average	N/A	5:1
Zone 2: High Activity, High-Retail Zone	<i>Opportunity for feature lighting; variety of light types encouraged; contributing ambient light from ground-floor uses</i>			
	Mission Rock Square	0.5-0.8 fc Average	N/A	40:1
	Shared Public Way	1 fc Average	0.4 to 1 fc	4 to 6
Zone 3: Working Waterfront	<i>Working Waterfront. Iconic lighting; intersections should be highly visible.</i>			
	Terry A Francois Boulevard	1 fc Average	0.4 to 1.7 fc 1.8 fc at intersections	3 to 6
Zone 4: Neighborhood Streets	<i>Some contributing light from ground-floor uses, especially on Bridgeview Street. Intersections should be highly visible.</i>			
	Bridgeview Street & Exposition Street	0.5-0.8 fc Average	0.4 to 1.2 fc 1.4-1.8 at intersections	4 to 6
	Long Bridge Streets	1 fc Average	0.4 to 1.2 fc 1.4-1.8 at intersections	3 to 6
Zone 5: Gateways	<i>Opportunity for overhead lighting.</i>			
	Channel Street	1-1.2 fc Average	N/A	10:1
	Channel Lane	1-1.2 fc Average	N/A	10:1
Zone 6: District Streets	<i>Mission Bay. Refer to OCII Mission Bay controls.</i>			
	3rd & Mission Rock Streets (See OCII Standards)			

*Source: Better Streets Plan <www.sfbetterstreets.org/find-project-types/streetscape-elements/street-lighting/>

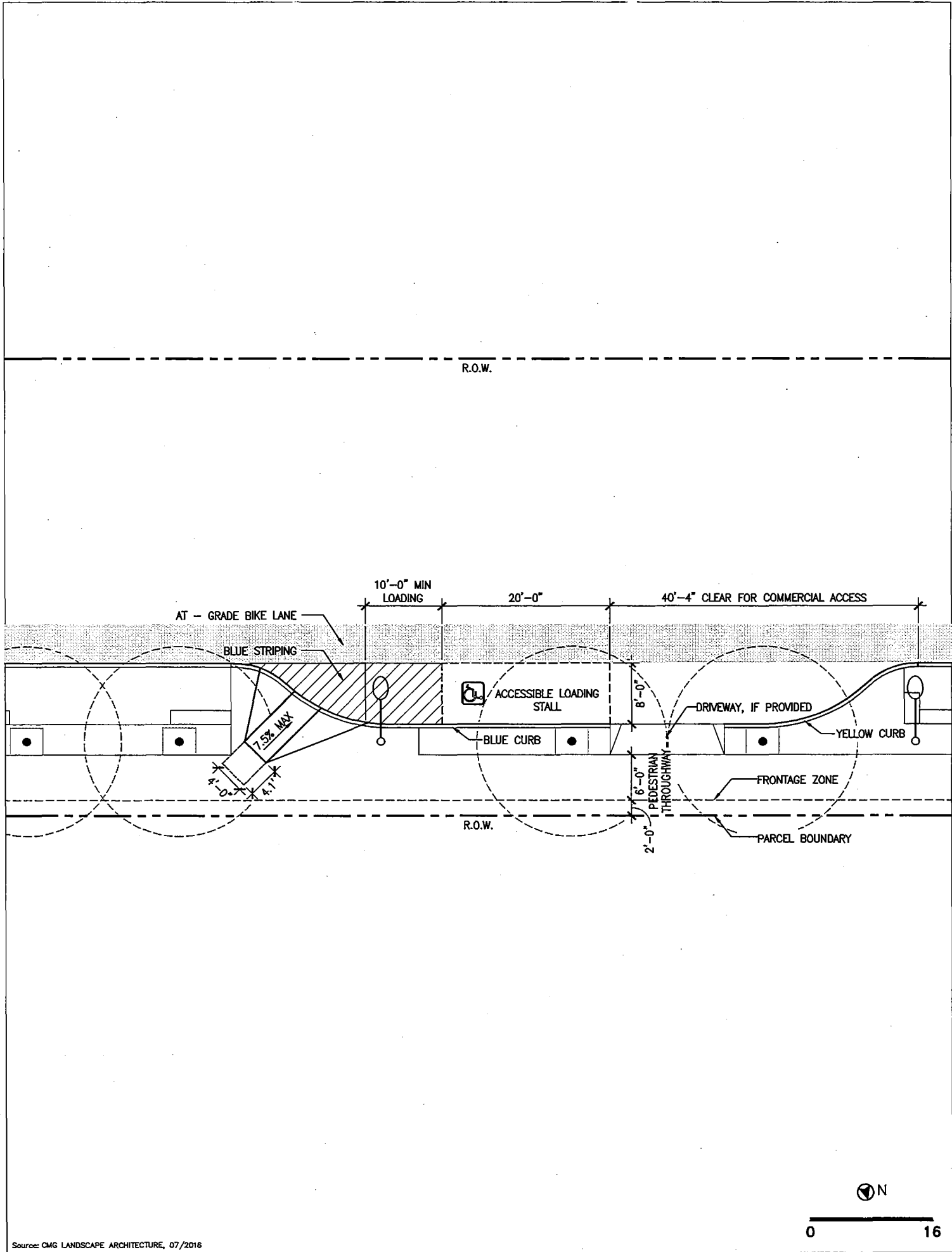

Source: OMG LANDSCAPE ARCHITECTURE, 07/2016

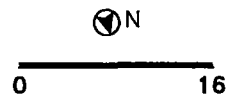

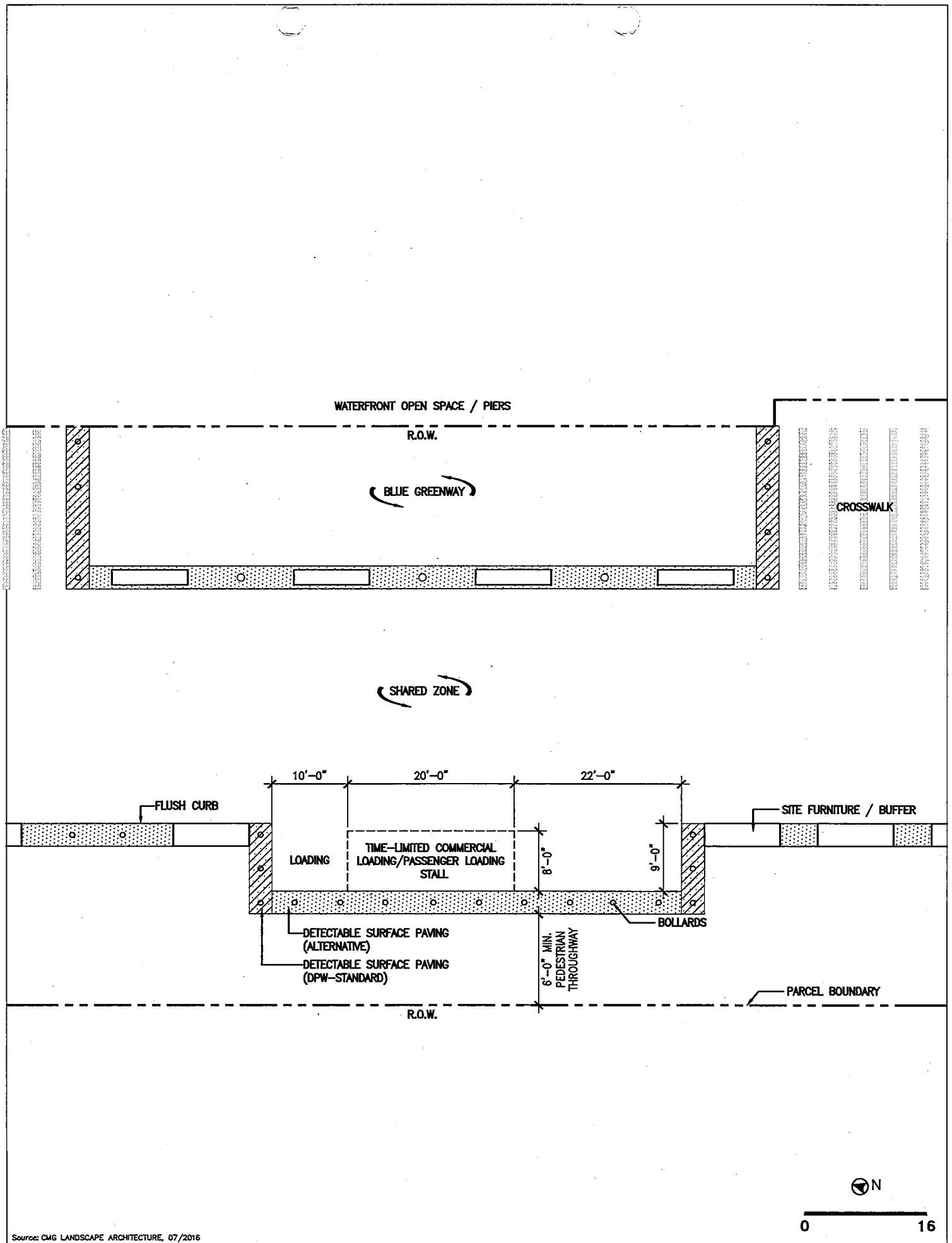

Source: CMG LANDSCAPE ARCHITECTURE, 07/2016

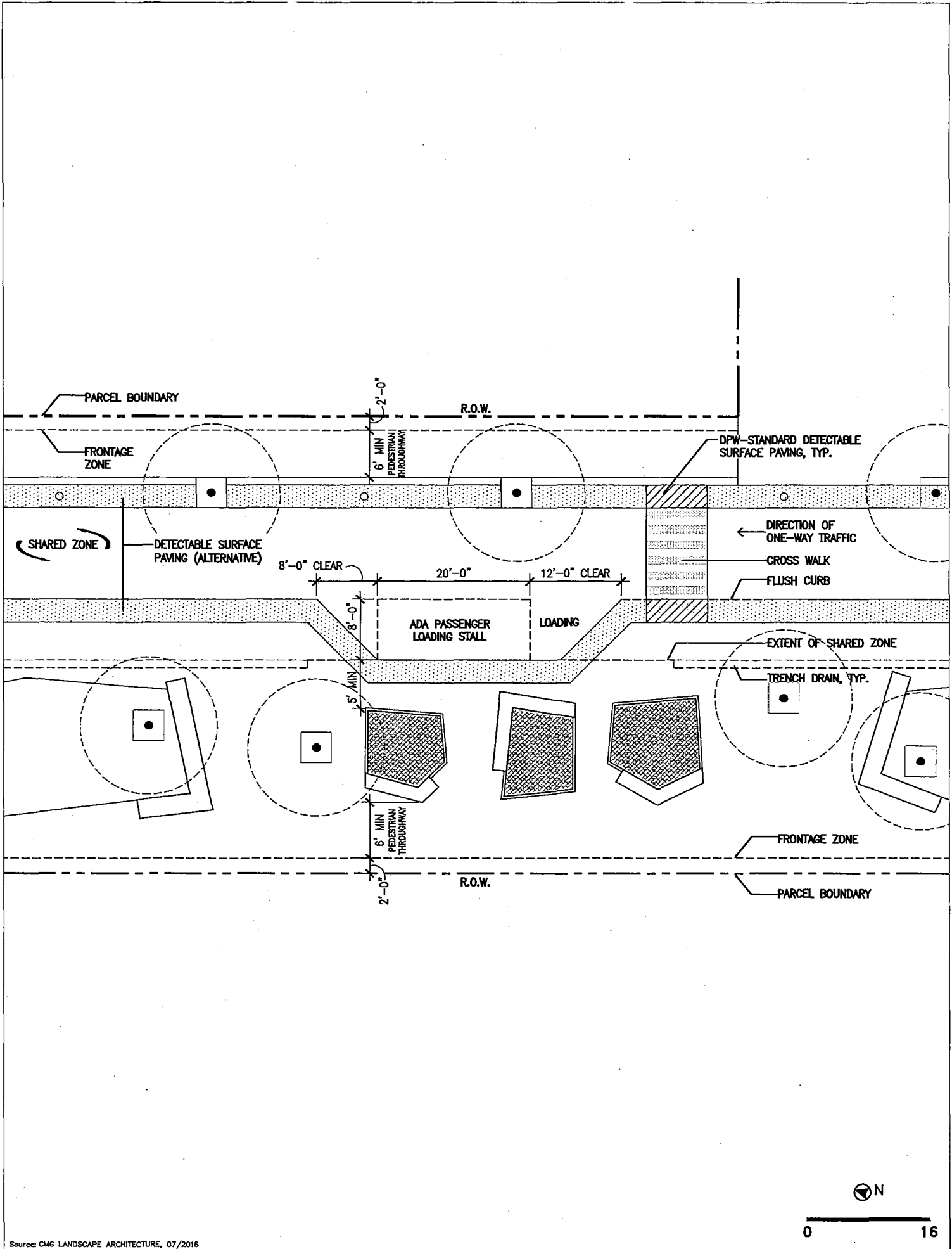

Source: CMG LANDSCAPE ARCHITECTURE, 07/2016

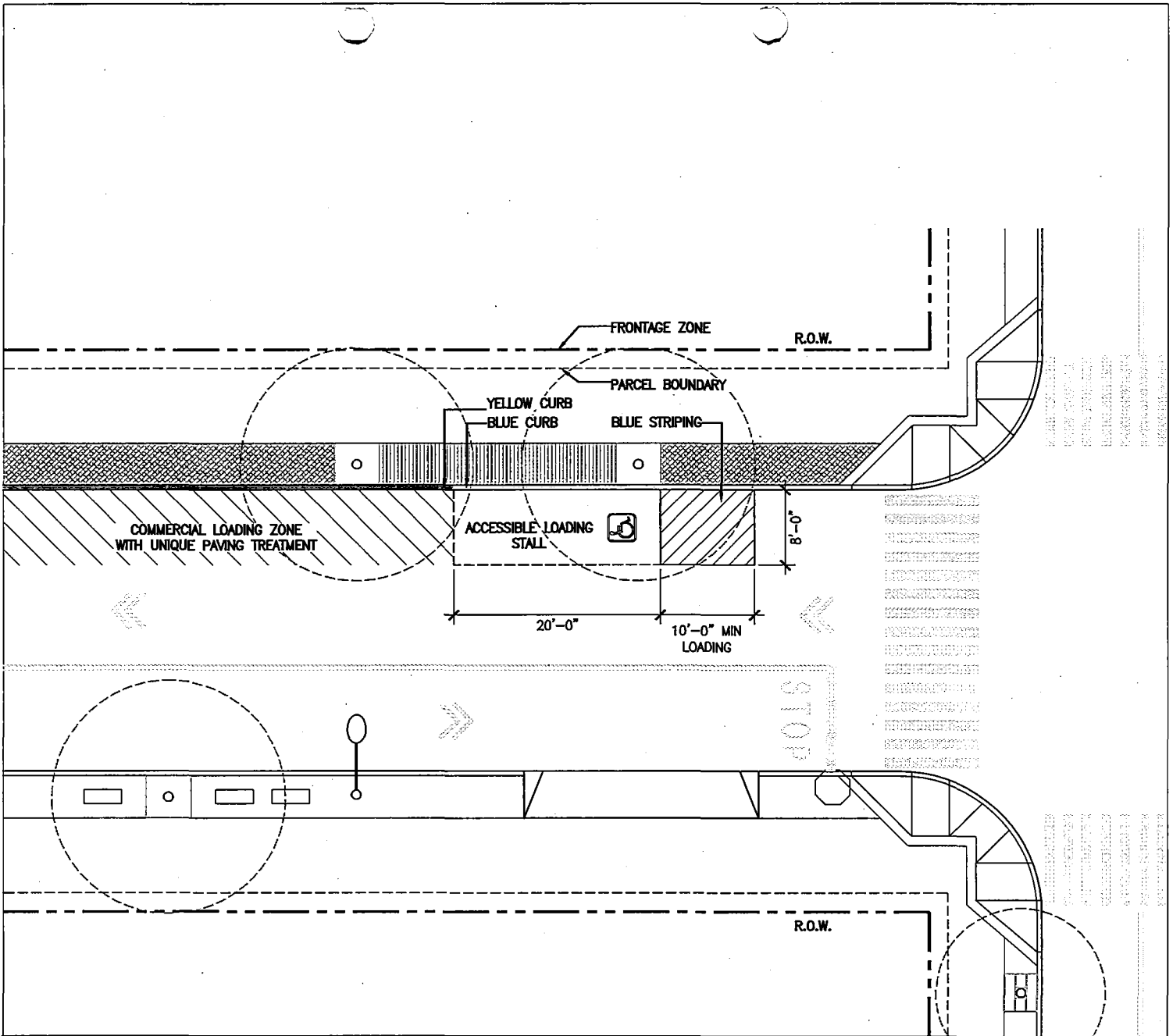

1. ALL LOADING ZONES SHALL BE PAVED WITH 4" COMPACTED GRANULAR FILL OVER 4" ASPHALT.

2. THE ACCESSIBLE LOADING STALL SHALL BE PAVED WITH 4" COMPACTED GRANULAR FILL OVER 4" ASPHALT.

3. THE COMMERCIAL LOADING ZONE SHALL BE PAVED WITH 4" COMPACTED GRANULAR FILL OVER 4" ASPHALT.

4. THE FRONTAGE ZONE SHALL BE PAVED WITH 4" COMPACTED GRANULAR FILL OVER 4" ASPHALT.

5. THE R.O.W. SHALL BE PAVED WITH 4" COMPACTED GRANULAR FILL OVER 4" ASPHALT.

6. THE PARCEL BOUNDARY SHALL BE PAVED WITH 4" COMPACTED GRANULAR FILL OVER 4" ASPHALT.

7. THE YELLOW CURB SHALL BE 6" HIGH.

8. THE BLUE CURB SHALL BE 6" HIGH.

9. THE BLUE STRIPING SHALL BE 6" WIDE.

10. THE STOP SIGN SHALL BE 36" DIAMETER.

11. THE STOP SIGN SHALL BE 36" DIAMETER.

12. THE STOP SIGN SHALL BE 36" DIAMETER.

13. THE STOP SIGN SHALL BE 36" DIAMETER.

14. THE STOP SIGN SHALL BE 36" DIAMETER.

15. THE STOP SIGN SHALL BE 36" DIAMETER.

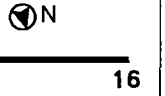

DRAWING NAME: \\BNF-SF\vol14\2008\000006\Mission Rock\ENG\Exhibits\Infrastructure Plan Exhibits\Plotted Sheets\Figure 8.58 Potential Traffic Calming Elements.dwg
 PLOT DATE: 07-13-17
 PLOTTED BY: FEL

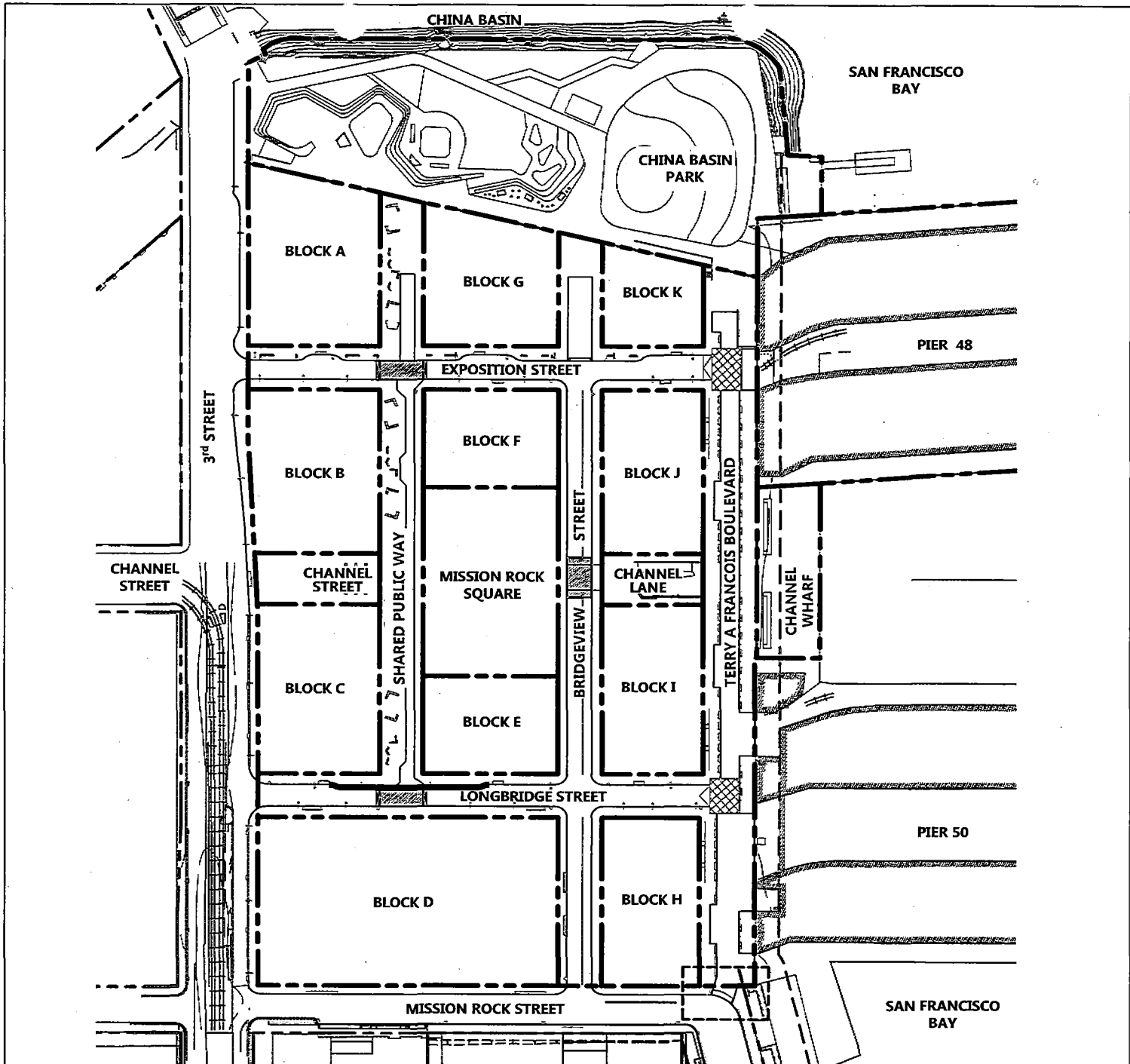

LEGEND

- PROPOSED PARCEL LINE
- EXISTING PARCEL LINE
- RAISED CROSSWALK, SEE FIGURE 8.59
- BULB-OUT LOCATIONS
- CITY STANDARD DRIVEWAY AT TERRY A FRANCOIS BOULEVARD & MISSION ROCK STREET INTERSECTION
- RAISED INTERSECTION AT TERRY A FRANCOIS BOULEVARD



0 200

Source: BNF ENGINEERS, 07/2018

\\BKF-SF\vol1\2008\080006_Mission Rock\ENR\Exhibits\Infrastructure Plan Exhibits\Plotted Sheets\Figure 8.58 Typical Raised Crossing & Bulb-Out Details.dwg
DRAWING NAME: 07-15-17
PLOT DATE: FEL

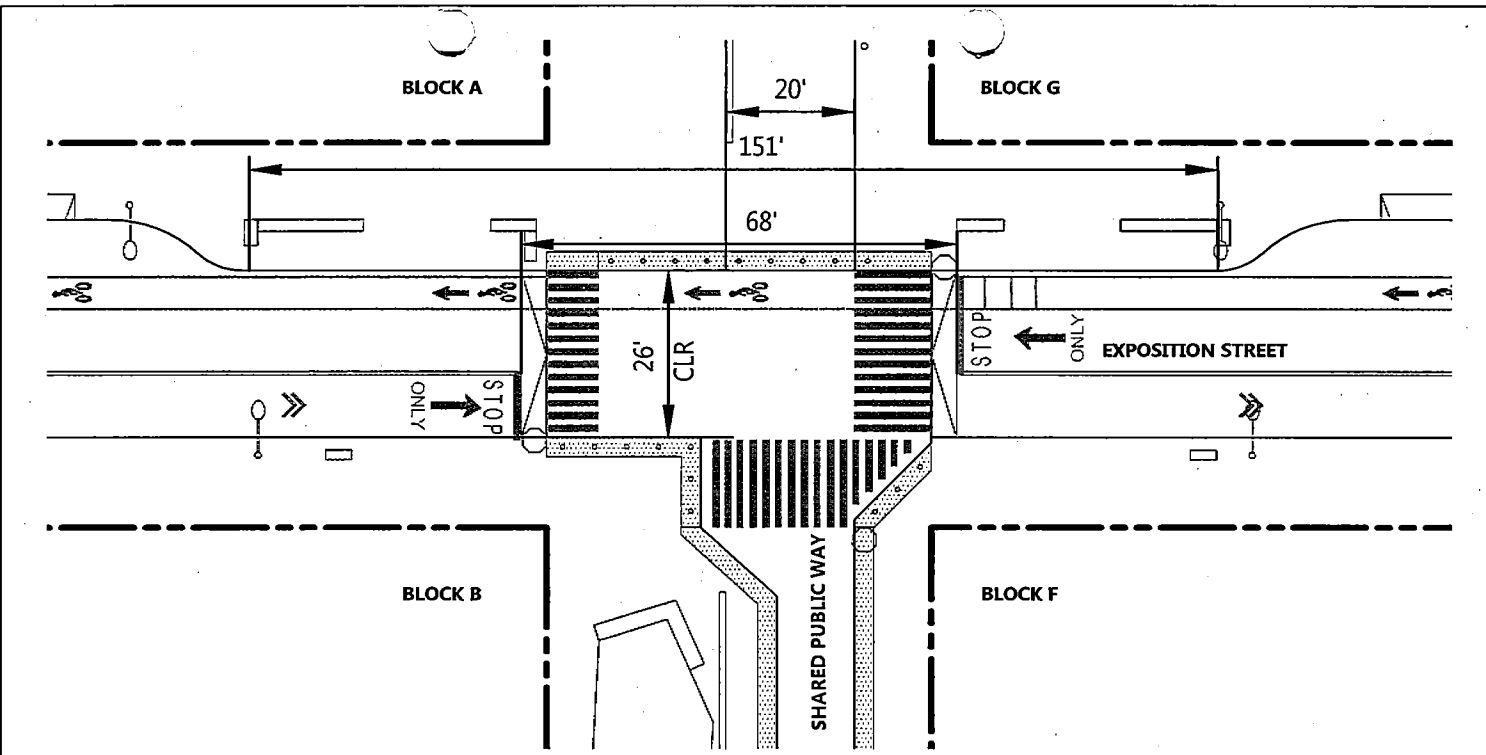

TYPICAL RAISED CROSSING

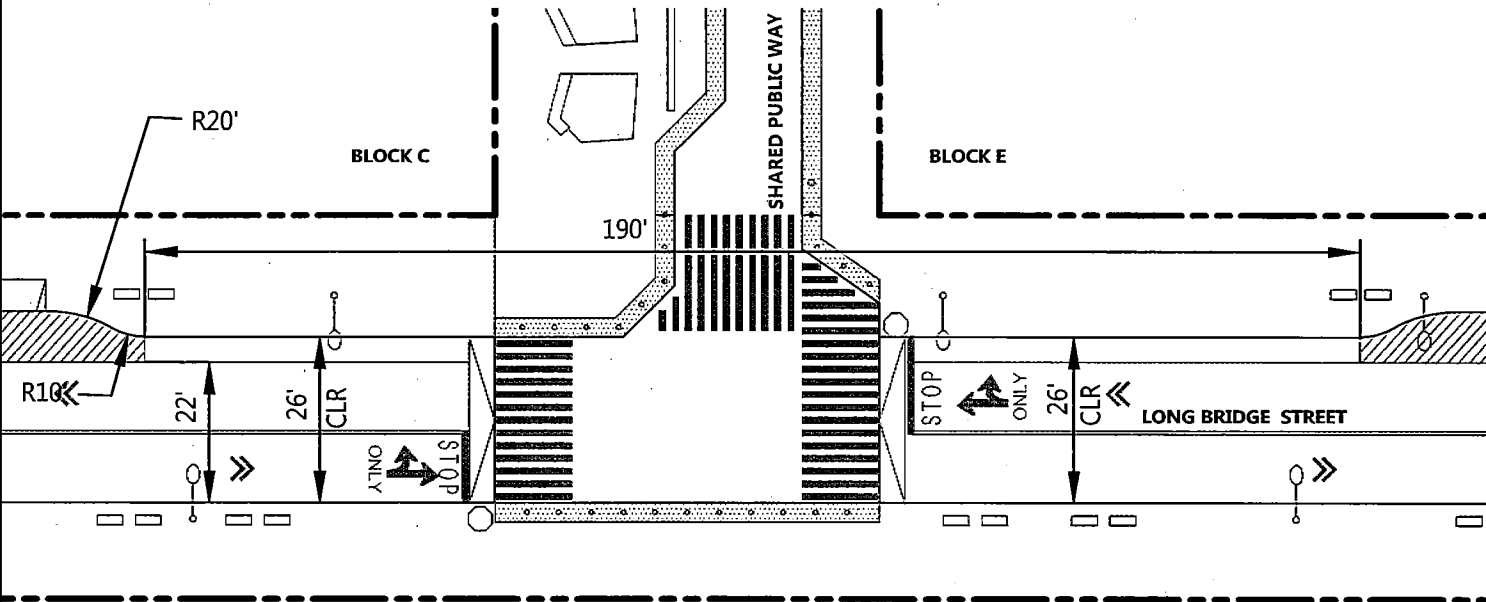

TYPICAL BULB-OUT

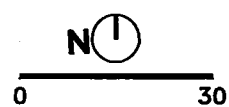





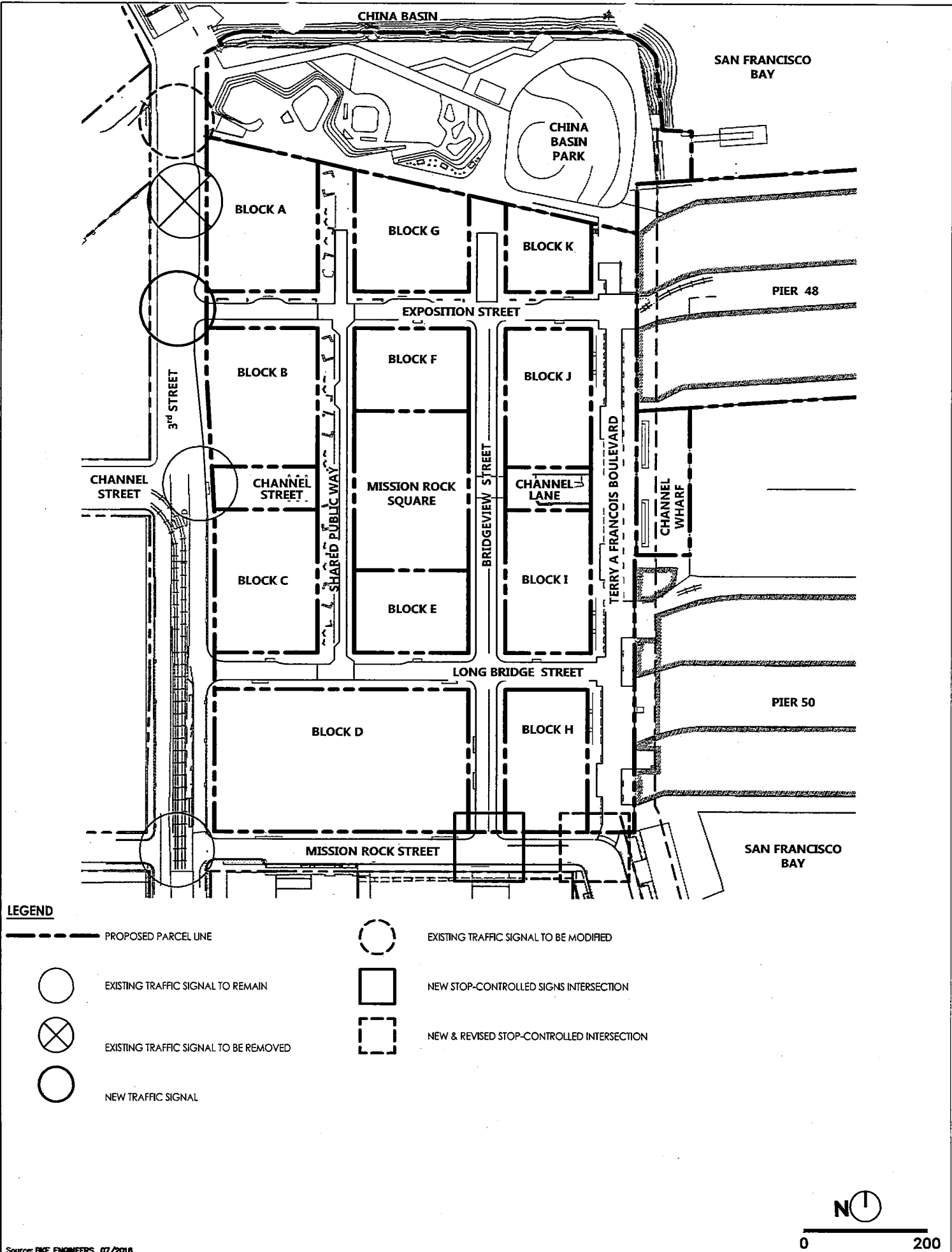

Source: BKF ENGINEERS, 07/2016

DRAWING NAME: \\BKF-SF\vol14\2008\060000\mission rock\ENG\Exhibits\Infrastructure Plan Exhibits\Plotted Sheets\Figure 8.60 Off-Site Traffic Mitigations.dwg
 PLOT DATE: 07-13-17
 PLOTTED BY: FELI



LEGEND

-  PROPOSED PARCEL LINE
-  EXISTING TRAFFIC SIGNAL TO REMAIN
-  EXISTING TRAFFIC SIGNAL TO BE REMOVED
-  NEW TRAFFIC SIGNAL
-  EXISTING TRAFFIC SIGNAL TO BE MODIFIED
-  NEW STOP-CONTROLLED SIGNS INTERSECTION
-  NEW & REVISED STOP-CONTROLLED INTERSECTION

Source: BKF ENGINEERS, 07/2016

DRAWING NAME: \\BKF-SF\vol14\2008\000000\Mission Rock\ENG\Exhibits\Infrastructure Plan Exhibits\Plotted Sheets\Figure 8.61 On-site Traffic Mitigations.dwg
 PLOT DATE: 07-13-17
 PLOTTED BY: boyo

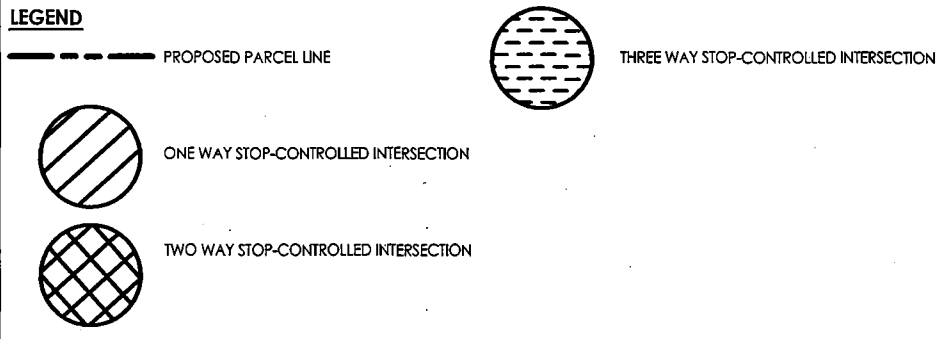
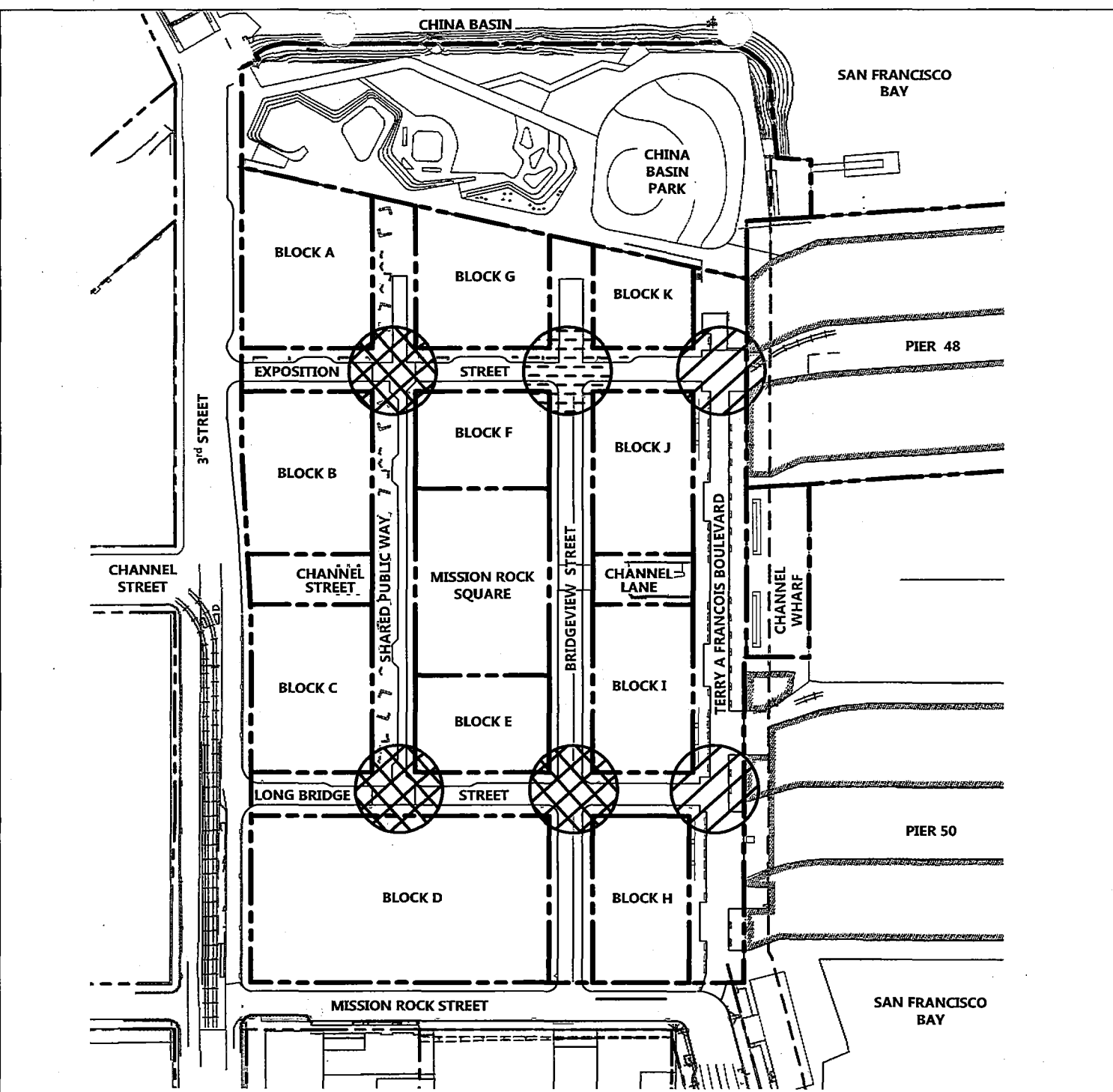

Source: BKF ENGINEERS, 07/2016

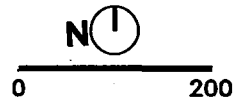

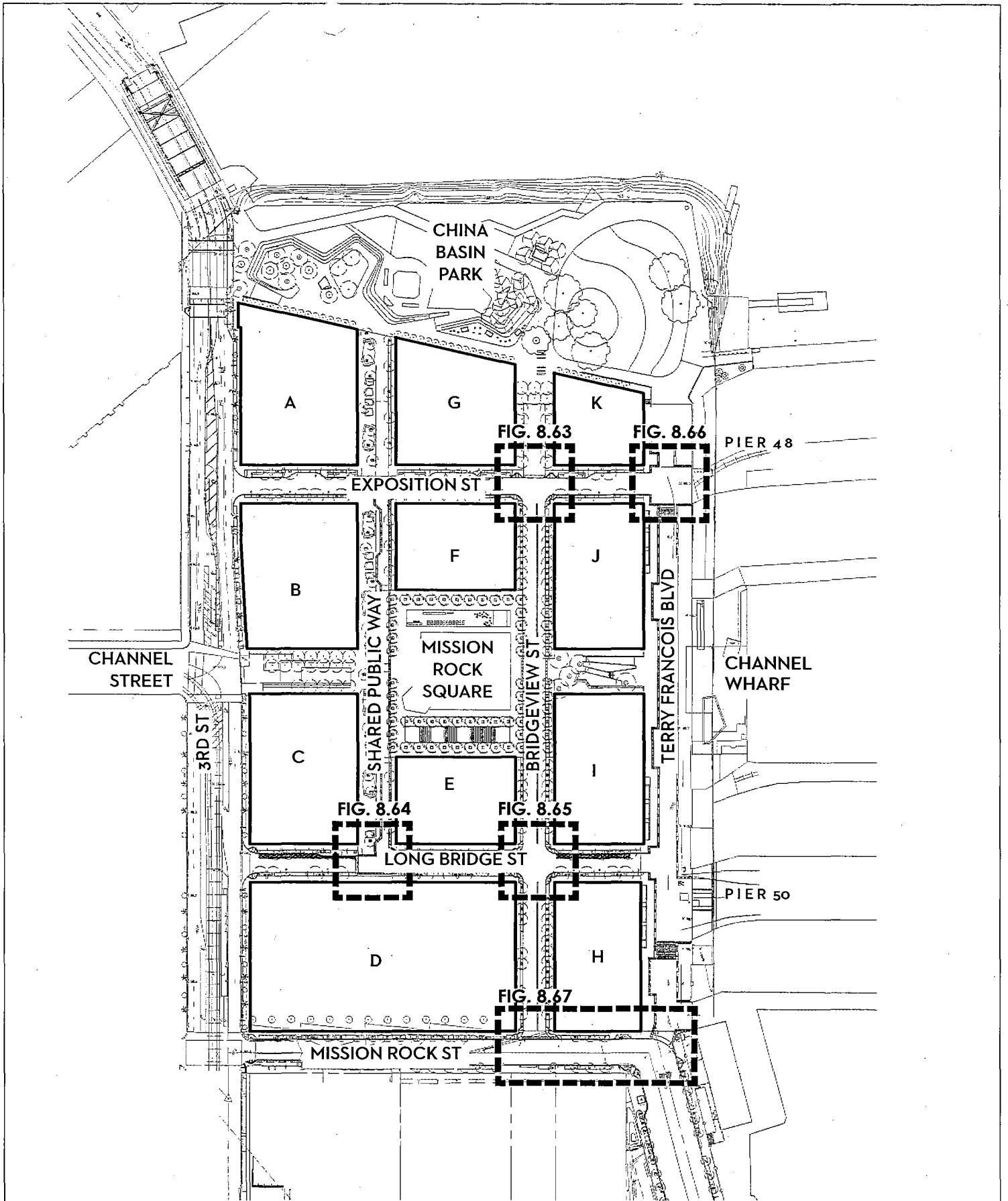

Proposed Parcel Line



0 200

Source: CMG LANDSCAPE ARCHITECTURE, 07/2016

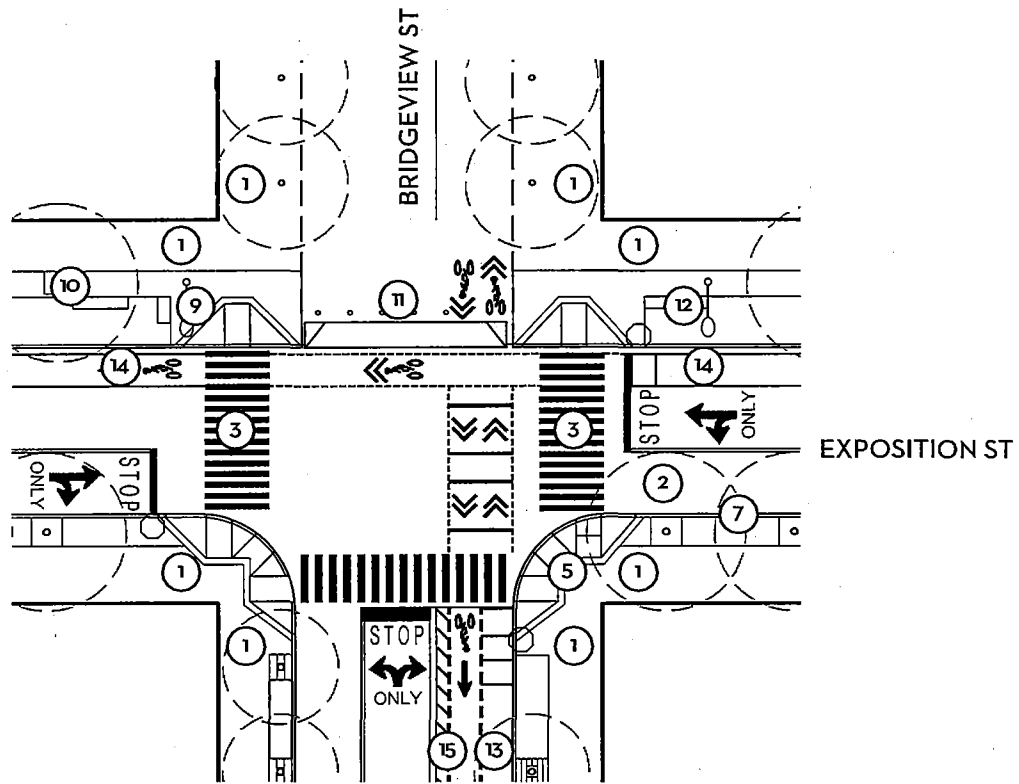

TYPICAL INTERSECTION ALL-WAY STOP: EXPOSITION STREET AT BRIDGEVIEW STREET

- | | |
|--|------------------------------|
| ① Pedestrian Throughway | ⑧ Flush Curb |
| ② Vehicular Travelway | ⑨ Streetlight |
| ③ Crosswalk | ⑩ Street Tree |
| ④ Raised Intersection | ⑪ Bollards |
| ⑤ DPW Standard Curb Ramp | ⑫ Street Furnishing |
| ⑥ DPW Standard Detectable Surface Paving | ⑬ Cycle Track (Raised) |
| ⑦ DPW Standard Curb | ⑭ Bike Lane at Roadway Grade |
| | ⑮ Cycle Track Buffer |



0 30

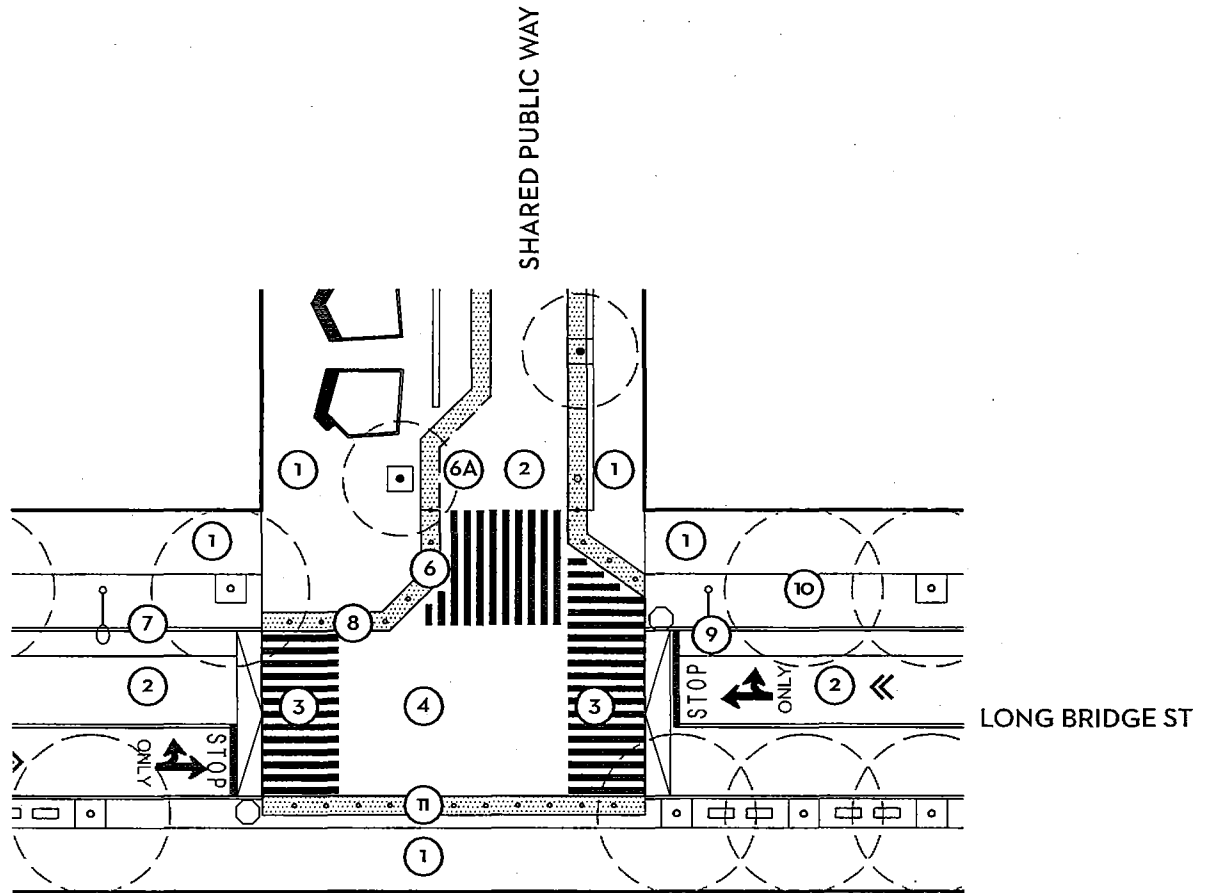

RAISED INTERSECTION: SHARED PUBLIC WAY AT LONG BRIDGE STREET

- | | |
|---|------------------------------|
| ① Pedestrian Throughway | ⑦ DPW Standard Curb |
| ② Vehicular Travelway | ⑧ Flush Curb |
| ③ Crosswalk | ⑨ Streetlight |
| ④ Raised Intersection | ⑩ Street Tree |
| ⑤ DPW Standard Curb Ramp | ⑪ Bollards |
| ⑥ DPW Standard Detectable Surface Paving | ⑫ Street Furnishing |
| ⑥A Detectable Surface Paving: Alternative | ⑬ Cycle Track (Raised) |
| | ⑭ Bike Lane at Roadway Grade |



0 30

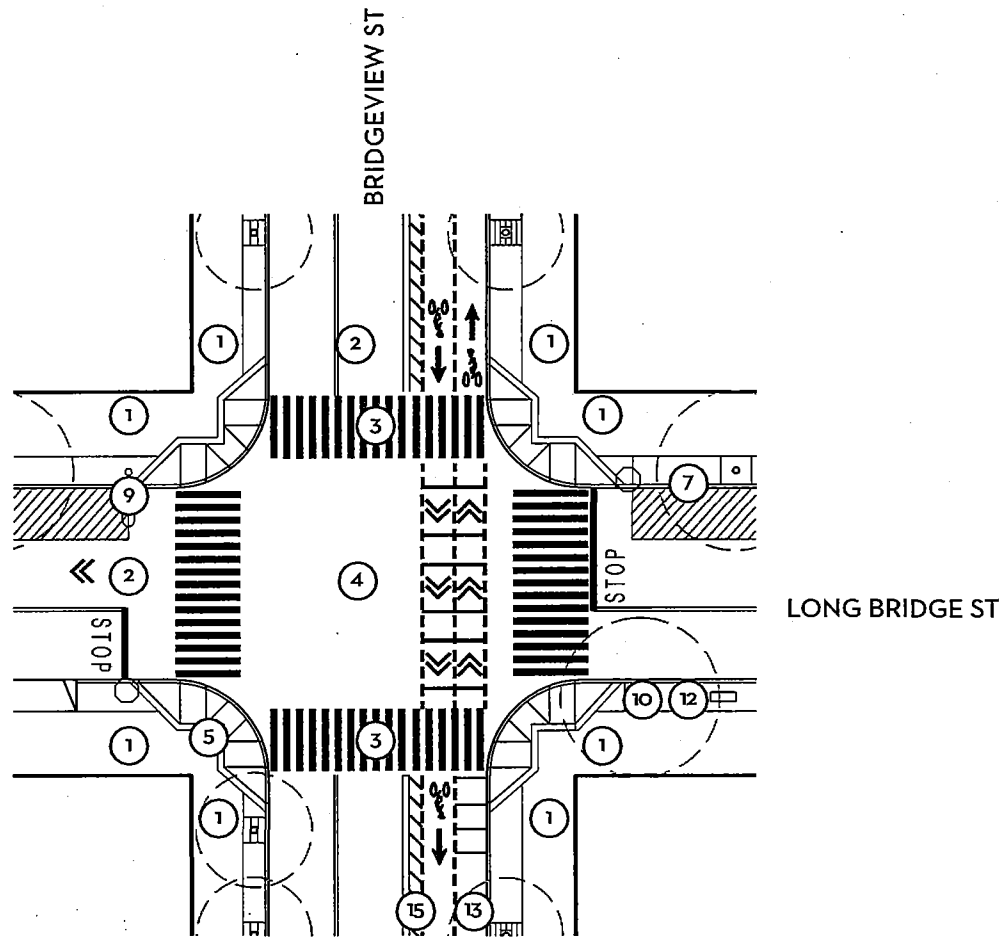

RAISED INTERSECTION / 2-WAY STOP: BRIDGEVIEW STREET AT LONG BRIDGE STREET

- | | |
|--|------------------------------|
| ① Pedestrian Throughway | ⑧ Flush Curb |
| ② Vehicular Travelway | ⑨ Streetlight |
| ③ Crosswalk | ⑩ Street Tree |
| ④ Raised Intersection | ⑪ Bollards |
| ⑤ DPW Standard Curb Ramp | ⑫ Street Furnishing |
| ⑥ DPW Standard Detectable Surface Paving | ⑬ Cycle Track (Raised) |
| ⑦ DPW Standard Curb | ⑭ Bike Lane at Roadway Grade |
| | ⑮ Cycle Track Buffer |



0 30

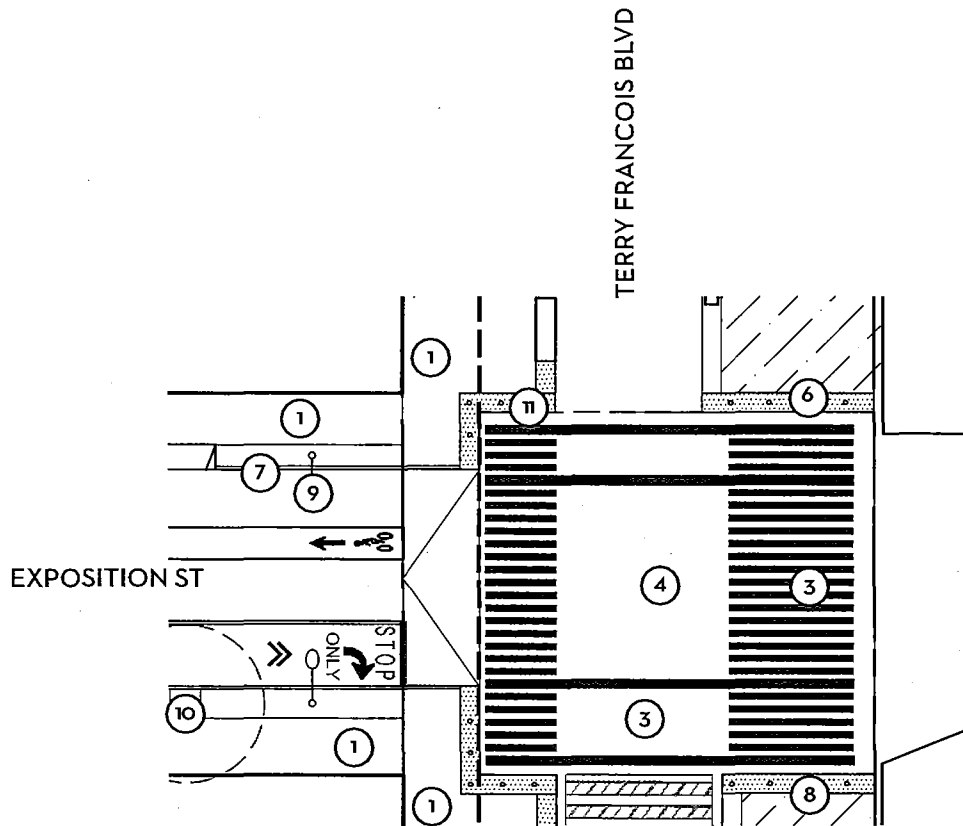

FLUSH INTERSECTION: TERRY FRANCOIS BOULEVARD AT PIER 48

- | | |
|--|------------------------------|
| ① Pedestrian Throughway | ⑧ Flush Curb |
| ② Vehicular Travelway | ⑨ Streetlight |
| ③ Crosswalk | ⑩ Street Tree |
| ④ Raised Intersection | ⑪ Bollards |
| ⑤ DPW Standard Curb Ramp | ⑫ Street Furnishing |
| ⑥ DPW Standard Detectable Surface Paving | ⑬ Cycle Track (Raised) |
| ⑦ DPW Standard Curb | ⑭ Bike Lane at Roadway Grade |



0 30

- ① Pedestrian Throughway
- ② Vehicular Travelway
- ③ Crosswalk
- ④ Raised Intersection
- ⑤ DPW Standard Curb Ramp
- ⑥ DPW Standard Detectable Surface Paving
- ⑦ DPW Standard Curb
- ⑧ Flush Curb
- ⑨ Streetlight
- ⑩ Street Tree
- ⑪ Bollards
- ⑫ Street Furnishing
- ⑬ Cycle Track (Raised)
- ⑭ Bike Lane at Roadway Grade
- ⑮ Cycle Track Buffer
- ⑯ Cycle Track (At Grade)
- ⑰ Curb Ramp for Bike Access

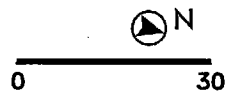
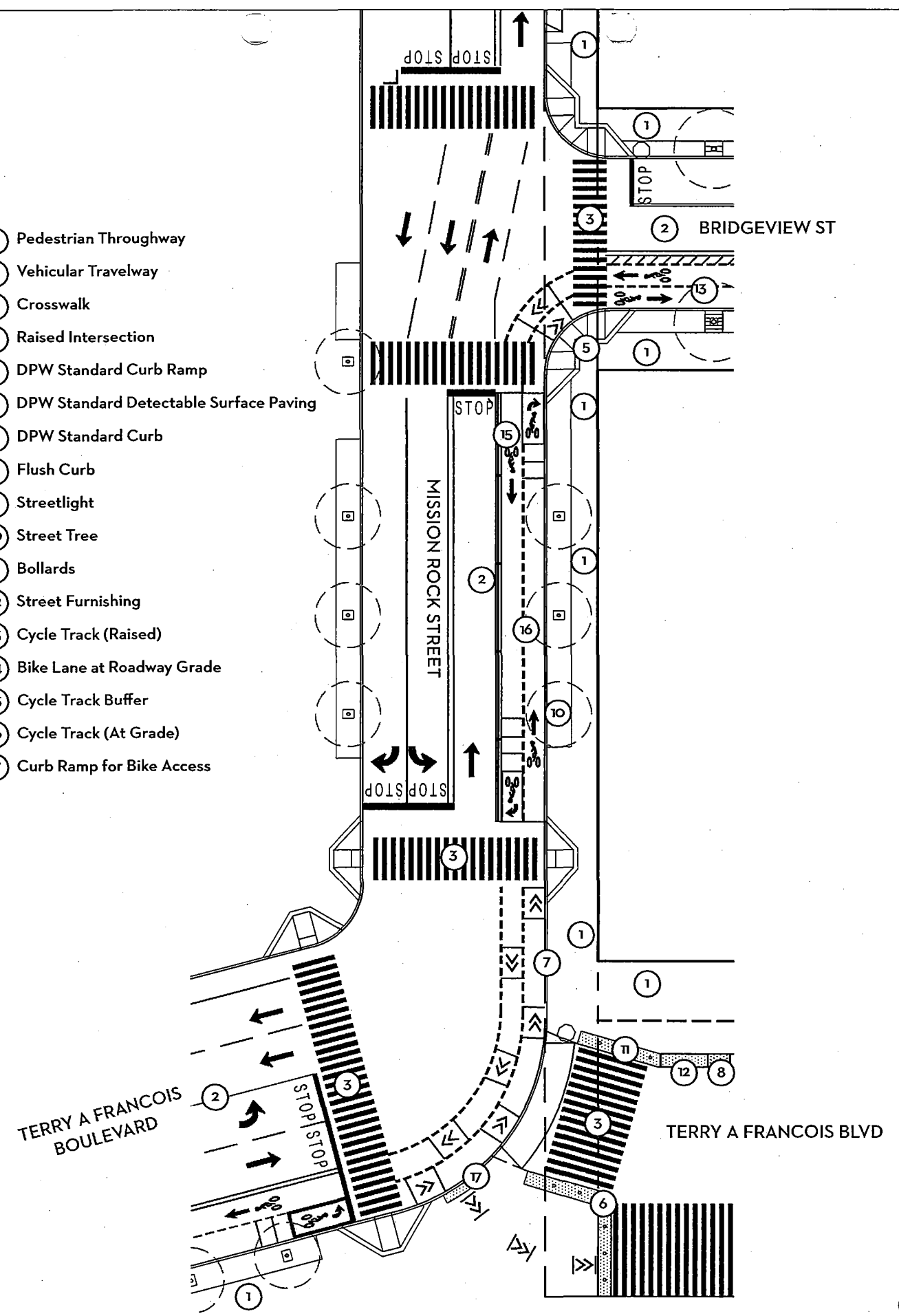

Source: QMG LANDSCAPE ARCHITECTURE, 07/2016

9. OPEN SPACE AND PARKS

The following describes the phasing of construction of open space and parks in connection with the Development Parcels. Unless specifically identified otherwise in the Section, ownership, maintenance, and acceptance of the open space and park areas will be by the Master Developer or Port, subject to the terms of the DDA.

9.1 Open Space

Open space shall be substantially Completed consistent with the following schedule:

9.1.1 China Basin Park

China Basin Park will be constructed in connection with the adjacent Development Parcels A, G and K, as further described in the associated Public Improvement Agreement(s) (PIA) for such Development Parcels. Construction of China Basin Park, including, without limitation, the portions of the park located between and adjacent to Development Parcels A and G and Development Parcels G and K, may be sequenced in relation to the phasing of such adjacent Development Parcels or to accommodate the need for construction staging or likelihood of site disturbances associated with construction of the adjacent Development Parcels.

9.1.2 Mission Rock Square

Mission Rock Square will be constructed in connection with the adjacent Development Parcels (E and F), as further described in the associated PIAs for such Development Parcels. Construction may be sequenced or adjusted as needed to accommodate construction of adjacent Development Parcels.

9.1.3 The Blue Greenway and the non-pile supported portion of Channel Wharf

The Blue Greenway and the non-pile supported portion of Channel Wharf (as described herein) will be constructed in connection with the construction of the adjacent portion of Terry A Francois Boulevard. The Blue Greenway is within the public street right-of-way of Terry A Francois Boulevard and will be owned and maintained by the Acquiring Agency.

9.1.4 Channel Street

Channel Street will be constructed in connection with the adjacent Development Parcels (B and C) as further described in the associated PIAs for such Development Parcels. Construction may be sequenced or adjusted as needed to accommodate construction of adjacent Development

Parcels. Ownership and maintenance and liability for Channel Street and encroachments thereon shall be addressed as set forth in the ICA or future MOA or MOU.

9.1.5 Channel Lane

Channel Lane will be constructed in connection with the adjacent Development Parcels (I and J) as further described in the associated PIAs for such Development Parcels. Construction may be sequenced or adjusted as needed to accommodate construction of adjacent Development Parcels. Ownership and maintenance and liability for Channel Lane and encroachments thereon shall be addressed as set forth in the ICA or future MOA or MOU.

9.1.6 Pier 48 Apron and the pile supported portion of Channel Wharf

The Pier 48 apron and the pile supported portion of Channel Wharf will be renovated, replaced or constructed in connection with the development of Pier 48. The Pier 48 Apron will be owned, maintained, and accepted by the Port.

FIGURE 9.1: PUBLIC OPEN SPACES

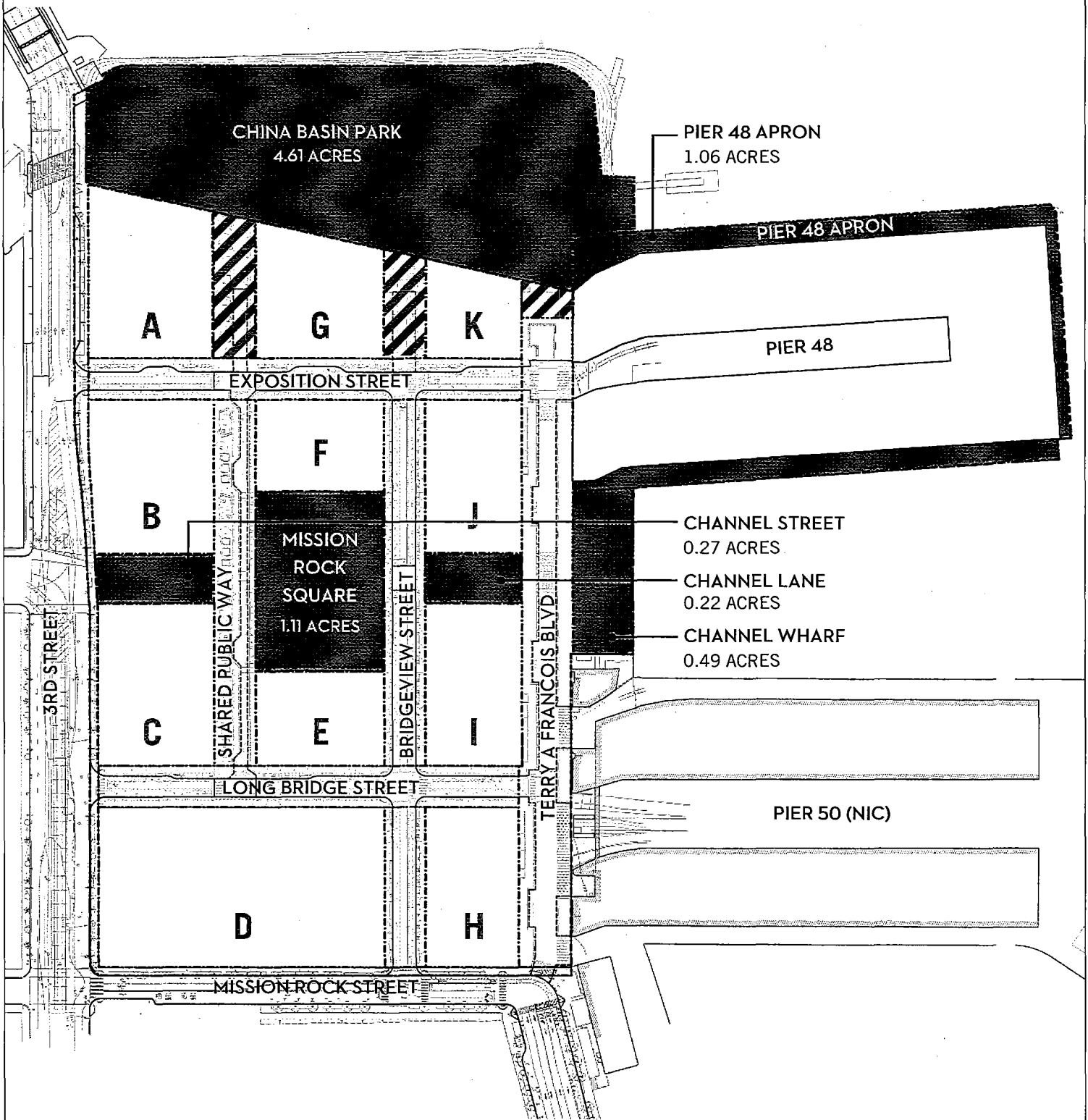

FIGURE 9.1: PUBLIC OPEN SPACES

- Public Open Spaces
- Paseo (Open Space within R.O.W.)
- Non-vehicular street connection; accommodates emergency vehicle access. Refer to Section 8.
- Limit of Work

Source: CMG LANDSCAPE ARCHITECTURE, 07/2016

FIGURE 9.2: PHASING

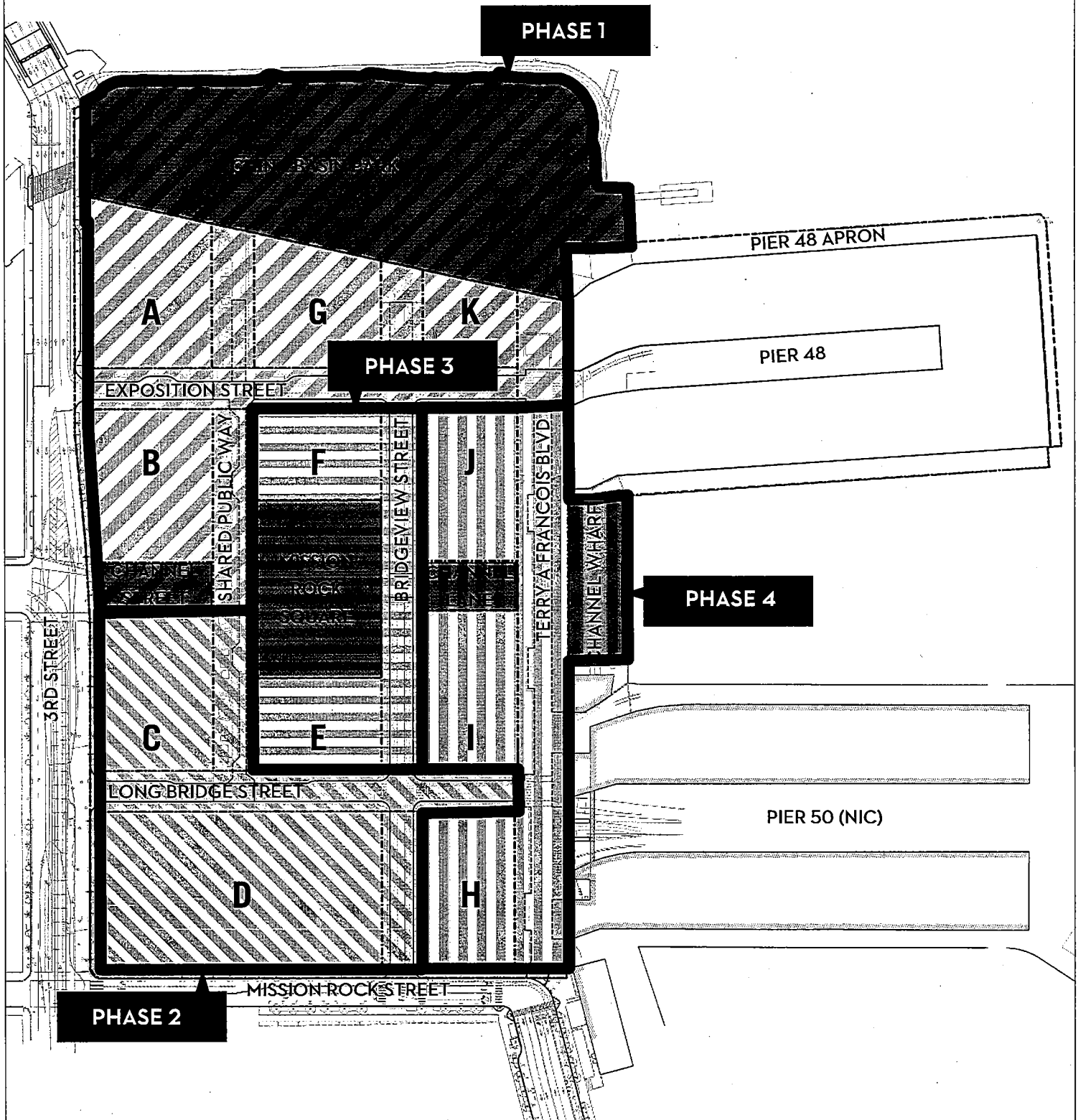

FIGURE 9.2: PHASING

- Public Open Spaces
- Phases of Development



Source: CMG LANDSCAPE ARCHITECTURE, 07/2016

10. UTILITY LAYOUT AND SEPARATIONS

10.1 Utility Systems

The Project proposes to install public utility systems, including the storm drainage system, separated sanitary sewer system, low pressure water (LPW) system, auxiliary water supply system (AWSS), and dry utility systems. Privately owned and maintained systems – district energy, greywater collection– will be installed to promote Project sustainability goals. Non-potable water infrastructure within the street right-of-ways will either be privately or publicly, by the SFPUC, owned or maintained. Ownership, maintenance, and acceptance responsibilities of utility infrastructure will be documented in the DA and DDA.

10.2 Utility Layout and Separation Criteria

Utility main layout and separations will be designed in accordance with the Subdivision Regulations and SFPUC Utility Standards. The Project proposes district energy cooling, non-potable water, and greywater collection systems which have utility separation requirements based on the Subdivision Regulations Diagram 2 and separation requirements provided by ARUP, shown in Appendix H. Utility main separation requirements are presented in Figure 10.1 Horizontal Utility Main Separation Matrix.

10.3 Conceptual Utility Layout

The Project utility layout is designed to connect the proposed Project utility infrastructure to the existing adjacent public utility infrastructure facilities. The proposed LPW system, shown on Figure 11.1, will be a looped system and have three connections to the existing SFPUC LPW system on 3rd Street and Mission Rock Street. The proposed separated sanitary system, shown on Figure 12.1, will have three connections to the existing SFPUC sanitary sewer system on both 3rd Street and Mission Rock Street. The proposed storm drainage system, shown on Figure 13.1, will have four connections to the existing SFPUC storm drain system on 3rd Street, a potential connection to the existing SFPUC storm drain system on Mission Rock Street, a connection to the existing Port outfall at China Basin, and a connection to the existing Port outfall at Channel Wharf, which, if accepted by the SFPUC as part of the Project, will be provided to the SFPUC subject to compliance the SFPUC standards for outfall design. The proposed AWSS, shown on Figure 14.1, will be a looped system a connection to the existing 12-inch AWSS main in 3rd Street at the Exposition Street intersection and to a future SFPUC AWSS main at the intersection of Mission Rock Street and Terry A Francois Boulevard. The district energy plant and infrastructure layout, shown on Figure 15.1, and greywater collection, shown on Figure 15.2 will be centralized at Block A. The bay source system will

be installed in China Basin Park to connect the district energy plant to the Bay. From Block A, District Energy and non-potable water will be provided to all Development Parcels.

10.4 Utility Layout and Clearance Design Modifications and Exceptions

Due to constraints within the Project site, design modifications and exceptions to standard sizing, spacing, and locations of utilities will be requested. A design modification and exception request to utility standards and requirements is subject to the review and approval by the department with authority over each utility. The separated sanitary sewer system, storm drainage system, LPW system, AWSS, and non-potable water system design modifications and exceptions receive authorization per the process outlined in the Subdivision Regulations. Potential locations for the design modifications and exceptions listed in this section are shown in Figure 10.2. Approval of this Infrastructure Plan does not constitute authorization of utility-related design modifications and exceptions.

10.4.1 Utility Main Clearance to Face of Curb

A bulb-out section, approximately 190-feet long, at the intersection of Long Bridge Street and Shared Public Way (SPW) will be provided for traffic calming purposes. The bulb-out reduces the face of curb to face of curb width from 30-feet to 26-feet. The Low Pressure Water main separation to the face of curb is given priority which ultimately reduces the Storm Drain structure to face of curb separation to 0.3-feet from the required 4.5-feet clearance. If the AWSS main is removed from Long Bridge Street, as currently proposed based on recent discussions, 4.5-ft of clearance between the bulb-out and LPW main may be provided and a design modification and exception request would not be required.

SPW will not have a curb, and Terry A Francois Boulevard will utilize flush curbs. The clear street width is 20 feet on SPW, which does not provide adequate width for the horizontal layout of District Energy pipes, a non-potable water main, a LPW main, and a storm drainage main. Thus, the project proposes to locate the storm drainage main underneath the edge of the clear travel way and beneath the linear drainage element. Proposed storm drainage infrastructure would be accepted by the Acquiring Agency with maintenance completed through the HOA fees or CFD funds. If the SFPUC and City do not accept the infrastructure, then the Acquiring Agency will be the Port.

10.4.2 Utility Structure Type and Clearance to Face of Curb

TFB, SPW, and the northern segment of Bridgeview Street will utilize flush curbs in place of City standard curb and gutter design, eliminating feasible installation of City standard curb inlets. To accommodate the Project design approach, a linear drainage element, including but not limited to a valley gutter, inverted crown street, or trench drains, in combination with inlets at low points will be incorporated at or along the flowline to provide drainage. Proposed storm drainage infrastructure would be accepted by the Acquiring Agency with maintenance completed through the HOA fees or CFD funds.

10.4.3 Auxiliary Water Supply System Main within Sidewalk

The street width of Terry A Francois Boulevard is inadequate to provide horizontal clearance for all proposed utility mains within the street pavement. The proposed AWSS main will be located underneath the blue greenway on the east side of Terry A Francois Boulevard, as agreed upon between the developer and the City, SFFD, and SFPUC.

10.4.4 Storm Drain Main and Sanitary Sewer Main Layout Order

Per the Subdivision Regulations, street utility order places the storm drain main closest to the face of curb, then the sanitary sewer main closer to the centerline of the street section. In Terry A Francois Boulevard and Exposition Street, the utility order of the storm drain main and the sanitary sewer main is switched to place the sanitary sewer main closest to the face of curb instead of the storm drain main. This change in layout order provides better alignment with the storm drain connection on 3rd Street and reduces crossing conflicts between the sanitary sewer and storm drain systems.

Figure 10.1 - HORIZONTAL UTILITY MAIN SEPARATION

Utility Separation	Storm Drain	Sanitary Sewer	Sanitary Sewer Force Main	Potable Water (LPW)	Auxiliary Water Supply System	Recycled Water (Private)	Greywater Collection (Private)	District Energy (Private)	Structure Appurtenances of Other Utilities
Face of Curb	6.5' min FOC to CL sewer pipe or structure (Ref 1)	6.5' min FOC to CL sewer pipe or structure (Ref 1)	3.5' clear to OD (assumed from Ref 1)	4.5' clear to OD (Ref 4, see Note 1)	4.5' clear to OD (assumed from Ref 4, see Note 1)	4.5' clear to OD (assumed from Ref 4, see Note 1)	6.5' min FOC to CL greywater pipe or structure (Ref 1)	Street w/ CB: 4' clear to OD (assumed from Ref 1) Street w/o CB: 1' clear to OD (assumed from Ref 3)	---
Catch Basin	6" clear CB to MH, 1' clear to OD (Ref 1)	6" clear CB to MH, 1' clear to OD (Ref 1)	6" clear CB to utility structure, 1' clear to OD (Ref 1)	6" clear CB to utility structure, 1' clear to OD (Ref 1)	6" clear CB to utility structure, 1' clear to OD (Ref 1)	6" clear CB to utility structure, 1' clear to OD (Ref 1)	6" clear CB to utility structure, 1' clear to OD (Ref 1)	6" clear CB to utility structure, 1' clear to OD (Ref 1)	1' min clear OD to outside of structure
Storm Drain	---	3.5' min clear OD to OD (assumed from Ref 1)	3.5' min clear OD to OD (assumed from Ref 1)	4' clear OD to OD (Ref 2)	3.5' clear to OD (assumed from Ref 1)	3.5' clear to OD (assumed from Ref 1)	3.5' clear to OD (assumed from Ref 1)	3.5' clear to OD (assumed from Ref 1)	1' min clear OD to outside of structure
Sanitary Sewer	---	---	3.5' min clear OD to OD (assumed from Ref 1)	10' clear OD to OD (Ref 2)	3.5' min clear OD to OD (Ref 1)	3.5' min clear OD to OD (Ref 1)	3.5' min clear OD to OD (assumed from Ref 1)	3.5' min clear OD to OD (assumed from Ref 1)	1' min clear OD to outside of structure
Sanitary Sewer Force Main	---	---	---	10' min clear OD to OD (Ref 2)	3.5' min clear OD to OD (assumed from Ref 1)	3.5' min clear OD to OD (assumed from Ref 1)	3.5' min clear OD to OD (assumed from Ref 1)	3' min clear OD to OD (assumed from Ref 1)	1' min clear OD to outside of structure
Potable Water (LPW)	---	---	---	---	4' clear OD to OD (Ref 1 & 2)	4' clear OD to OD (Ref 1 & 2)	10' clear OD to OD (Ref 2)	4' clear OD to OD (assumed from Ref 1 & 2)	1' min clear OD to outside of structure
Auxiliary Water Supply System	---	---	---	---	---	3' clear to outside pipe (Ref 1)	3' clear to outside pipe (assumed from Ref 1)	3' min clear OD to OD (assumed from Ref 1)	1' min clear OD to outside of structure
Recycled Water	---	---	---	---	---	---	3' clear to outside pipe (assumed from Ref 1)	3' min clear OD to OD (assumed from Ref 1)	1' min clear OD to outside of structure
Greywater Collection	---	---	---	---	---	---	---	3' min clear OD to OD (assumed from Ref 1)	1' min clear OD to outside of structure
Structure Appurtenances of Other Utilities	---	---	---	---	---	---	---	---	2' min clear outside of structure to outside of structure

References

- 1 SFPUC Subdivision Regulations Diagram No. 2 Minimum Utilities Separation for Wastewater and Water - Separate Sewer System (dated October 2014)
- 2 CA Code of Regulations Title 22 Section 64572
- 3 District Energy Separations Per ARUP Detail Mission Rock Typical Trench Sections District Energy (dated 01/12/2016), see Appendix H of Infrastructure Report
- 4 SFPUC Drawing CDD-001 Standard Layout for Potable and Recycled Water Distribution Main Installation (dated Nov 2015)

Notes

- 1 Due to street width constraints LPW clearance to Face of Curb reduced but not less than 4' clear (SPW & Long Bridge)
- 2 Storm drain and sanitary sewer structures include manhole structures. Horizontal distances shall be measured from largest OD of manhole barrel.

Abbreviations

- | | | |
|--------------------|---------------------------------|---------------|
| CB - Catch Basin | MH - Manhole | w/ - with |
| CL - Centerline | MIN - Minimum | w/o - without |
| FOC - Face of Curb | OD - Outside Diameter (of Pipe) | |

DRAWING NAME: \\BK1-4\vo14\2008\000000.Mission Rock\ENG\Exhibits\Infrastructure Plan Exhibits\Plotted Sheets\Figure 10.2 Utility Variance Request Locations.dwg
 PLOT DATE: 11-16-17
 PLOTTED BY: voik

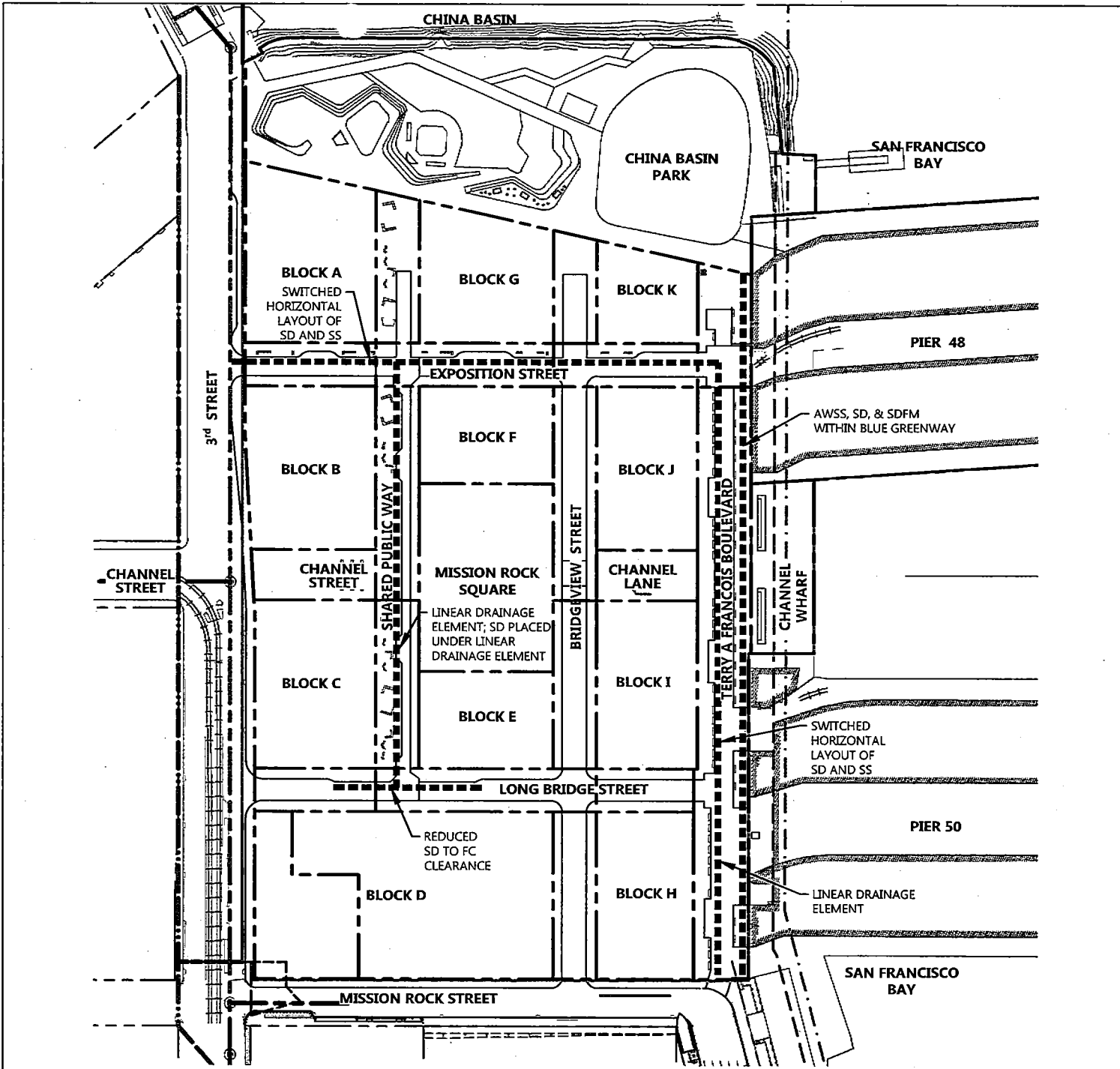

LEGEND

- PROPOSED PARCEL LINE
- - - EXISTING PARCEL LINE
- VARIANCE REQUEST LOCATION

ABBREVIATIONS

AWSS	AUXILIARY WATER SUPPLY SYSTEM
FC	FACE OF CURB
LG	LIP OF GUTTER
SD	STORM DRAIN MAIN
SS	SANITARY SEWER MAIN
FM	FORCE MAIN

Source: BKF ENGINEERS, 07/2016

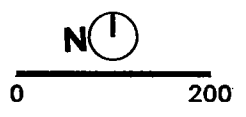

11. LOW PRESSURE WATER SYSTEM

11.1 Existing Low Pressure Water System

Potable water service is provided by a water supply, storage, and distribution system operated by the SFPUC. Existing LPW system infrastructure surrounds the site on Terry A Francois Boulevard (12-inch), 3rd Street (12-inch), and Mission Rock Street (12-inch). Fire hydrants and Piers 48 and 50 are serviced through the existing waterline in Terry A Francois Boulevard.

11.2 Existing SFPUC System Capacity

Based on the report, "Computer Modeling and Analysis of the Low Pressure Water System, Mission Bay Development" by Winzler & Kelly dated May 2000 (2000 LPW Report), the existing mains along 3rd Street, Mission Rock Street, and Terry A Francois Boulevard will have adequate capacity to support the Development and do not require replacement. Fire hydrant pressure and flow data from field tests of existing SFPUC hydrants adjacent to the project site will be used to verify the 2000 LPW report assumptions. This field data will be incorporated into the LPW water model and will be included as part of the Low Pressure Water Master Utility Plan (LPWMP).

11.3 Proposed Low Pressure Water System

11.3.1 Project Water Supply

The Project has been accounted for in the SFPUC's latest City-wide demand projections provided in its 2013 Water Availability Study¹ and the Water Supply Assessment prepared for and approved by the SFPUC in January 2017. As concluded previously, the Project would not require major expansions of the existing water system.

11.3.2 Project Water Demands

The Project water demands are identified in Table 11.1 below. The LPWMP will outline the Project's methods used for calculating the flow demands. The Project proposes bay source cooling, which provides significant water savings by reducing the quantity of cooling towers for the Project; however, the WSA assumed that each development parcel would incorporate independent heating and cooling systems, resulting in larger water demands than those assumed in Table 11.1

¹ <http://www.sfwater.org/modules/showdocument.aspx?documentid=4168>

**Table 11.1
Project Water Demands**

Scenario	Demand (gpm)
Domestic Average Day Demand (ADD)	450
Maximum Day Demand (MDD) (includes peaking factor of 1.6)	721
Peak-Hour Demand (PHD) (includes peaking factor of 2.4)	1,081
Required Fire-Flow	1,875
Maximum Demand (Max Day Demand + Required Fire-Flow)	2,596

11.3.3 Project Water Distribution System

The LPW system will be designed and constructed by the Developer, then owned and operated by the Acquiring Agency upon completion of construction and acceptance of the improvements. The proposed LPW system is identified schematically in Figure 11.1. Along 3rd Street, two new LPW connections are proposed at Exposition Street and Long Bridge Street to provide an on-site looped system. The proposed domestic water supply and fire protection system is anticipated to consist of 12-inch ductile iron pipe mains, LPW fire hydrants, valves and fittings, and appurtenances. The LPW infrastructure will be located within the paved area of the street such that the outside wall of a potable water pipe is a minimum of 4.5-feet clear from the face of curb and a minimum of 5-feet clear from the center of proposed tree trunks. A portion of the existing LPW system in Mission Rock Street between Terry A Francois Boulevard and proposed Bridgeview Street may require relocation to accommodate bicycle infrastructure coordinated with the SFMTA.

Vertical and horizontal separation distances between adjacent separated sewer systems, LPW infrastructure, and dry utilities will conform to the requirements outlined in Title 22 of the California Code of Regulations, the State of California Department of Health Services Guidance Memorandum 2003-02, and the Subdivision Regulations. Refer to the Typical Utility Section (Figure 11.2) for depth and relationship to other utilities. Required disinfection and connections to new mains will be performed by the SFPUC at the Developer's cost. Cathodic protection to be provided as required by the SFPUC. Based on a cathodic protection analysis, cathodic protection is to be completed during the Development Phase of the project.

11.3.4 Low Pressure Water Design Criteria

The proposed LPW system is required to maintain a minimum pressure of 20 psi and a maximum velocity of 12 fps during a Maximum Day Demand and maintain a minimum pressure of 40 psi and a maximum velocity of 8 fps during a Peak Hour Demand. The Project LPW system will be modeled in the LPWMP to confirm the on-site system infrastructure will meet pressure and flow requirements.

11.3.5 Proposed Fire Hydrant Locations

As shown on Figure 11.3, proposed on-site and off-site fire hydrants have been located at a maximum radial separation of 300-feet between hydrants. In addition, building fire department connections will be located within 100-feet of a fire hydrant. Final hydrant locations are subject to the approval of the SFFD, SFPUC, and will be located outside of the curb returns per DPW Order 175,387. If fire hydrants are required by SFFD within the curb returns to meet SFFD requirements, the Project will work with the SFPUC and SFDPW to request an exception per Sections VI and VII of DPW Order 175,387 to accommodate the SFFD. Fire hydrants shall not be located within landscape or bioretention areas and must have a paved direct path leading to the adjacent access road.

11.4 Phases for Low Pressure Water System Construction

The Developer will design and install the new LPW system based on the principle of adjacency and as-needed to facilitate a specific proposed Development Phase and consistent with the requirements of the DA, DDA and ICA. The amount and location of the proposed LPW systems installed will be the minimum necessary to support the Development Phase. The new Development Phase will connect to the existing systems as close to the edge of the Development Phase area as possible while maintaining the integrity of the existing system for the remainder of the Project. Repairs and/or replacement of the existing facilities necessary to support the proposed Development Phase will be designed and constructed by the Developer. Interim LPW systems will be owned, constructed, and maintained by the Developer as necessary to maintain existing LPW facilities impacted by proposed Development Phases, unless the SFPUC agrees to maintain interim facilities at the Developer's cost.

The SFPUC will be responsible for ownership and maintenance of existing SFPUC-owned LPW facilities. The Acquiring Agency will own and maintain the proposed LPW facilities once construction of the

horizontal improvements required for a Development Phase or a new LPW facility is complete and accepted by the Acquiring Agency. The Developer will be responsible for mitigating impacts to improvements installed with previous Project Development Phase(s) due to the designs or construction of current or future Development Phases, which will be addressed prior to approval of the construction drawings for the current or future Development Phase. For each Development Phase and concomitant with the submittal of Improvement Plans, the Developer will provide a phase-specific LPW Utility Report describing and depicting all existing LPW infrastructure to remain and demonstrating that the Development Phase will provide the required pressures and flow to the standards of the Acquiring Agency.

11.4.1 Existing Low Pressure Water System Demolition Phasing

The existing SFPUC-owned LPW system adjacent to the site along 3rd Street and Mission Rock Street will remain. The existing on-site 12-inch LPW main loops through Terry A Francois Boulevard connecting 3rd Street at the Lefty O'Doul Bridge to Mission Rock Street. The portion of this main along the frontage of Pier 48 and Pier 50 will remain to provide the piers service. This main will then be replaced with a 12-inch main connected to the Mission Rock LPW system during the redevelopment of Terry A Francois Boulevard. New connections will be made to Pier 48 and Pier 50 branching from the new LPW main.

DRAWING NAME: \\pkl-sf\vol14\2008\0800006_Mission Rock\Exhibits\Infrastructure Plan Exhibits\Plotted Sheets\Figure 11.1 Conceptual Low Pressure Water System.dwg
 PLOT DATE: 07-13-17
 PLOTTED BY: FEL

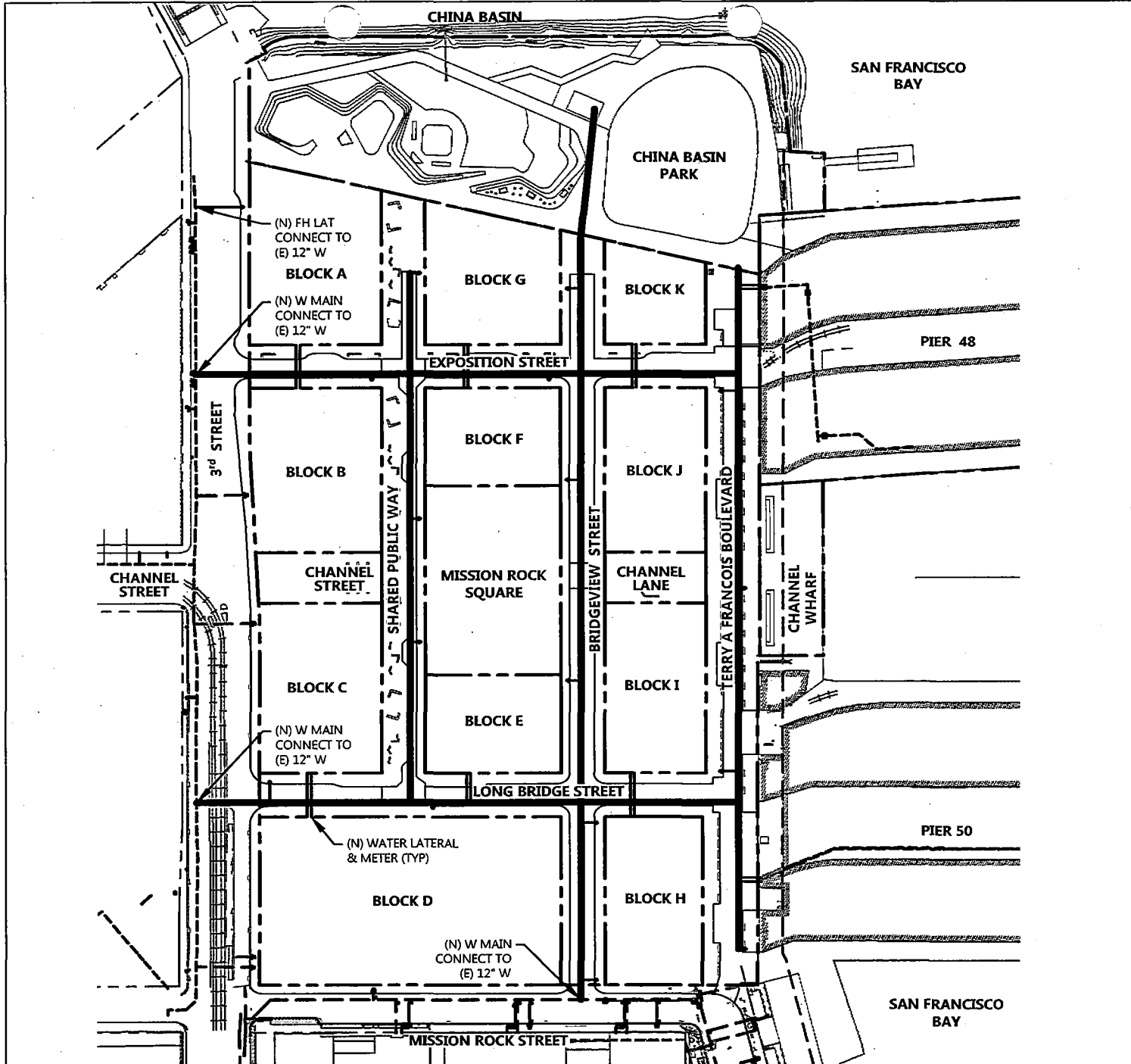

LEGEND

- PROPOSED PARCEL LINE
- - - EXISTING PARCEL LINE
- - - EXISTING WATER LINE
- PROPOSED WATER LINE (12" DIP)
- PROPOSED WATER LATERAL

Source: BRK ENGINEERS, 07/2016

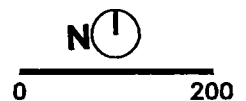

DRAWING NAME: \\pki-se\vol14\2008\080009_Mission Rock\ENG\Exhibits\Infrastructure Plan Exhibit\Plotted Sheets\Figure 11.2_14.2 Typical Utility Section.dwg
 PLOT DATE: 11-13-17
 PLOTTED BY: volk

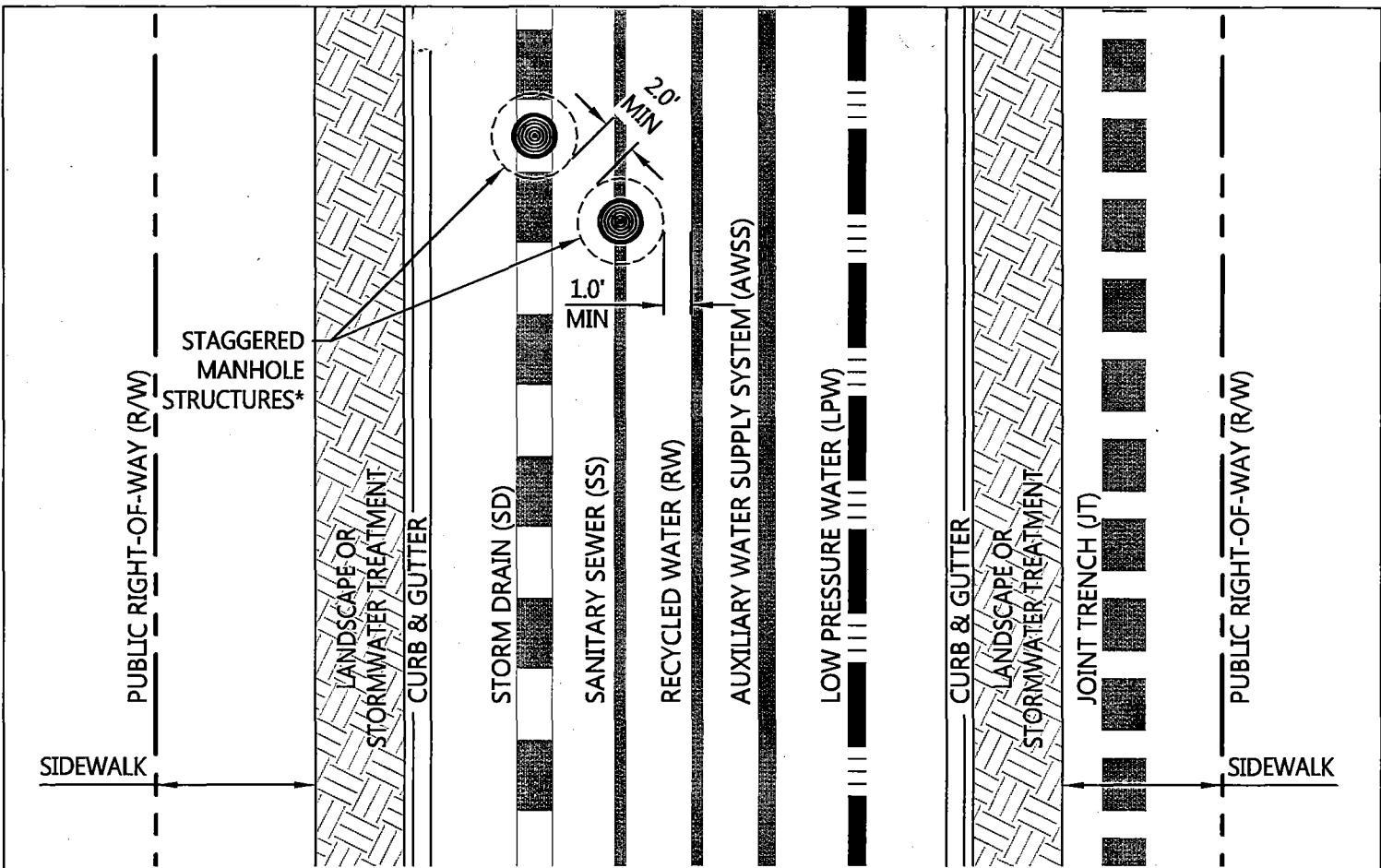

TYPICAL STREETS
NTS

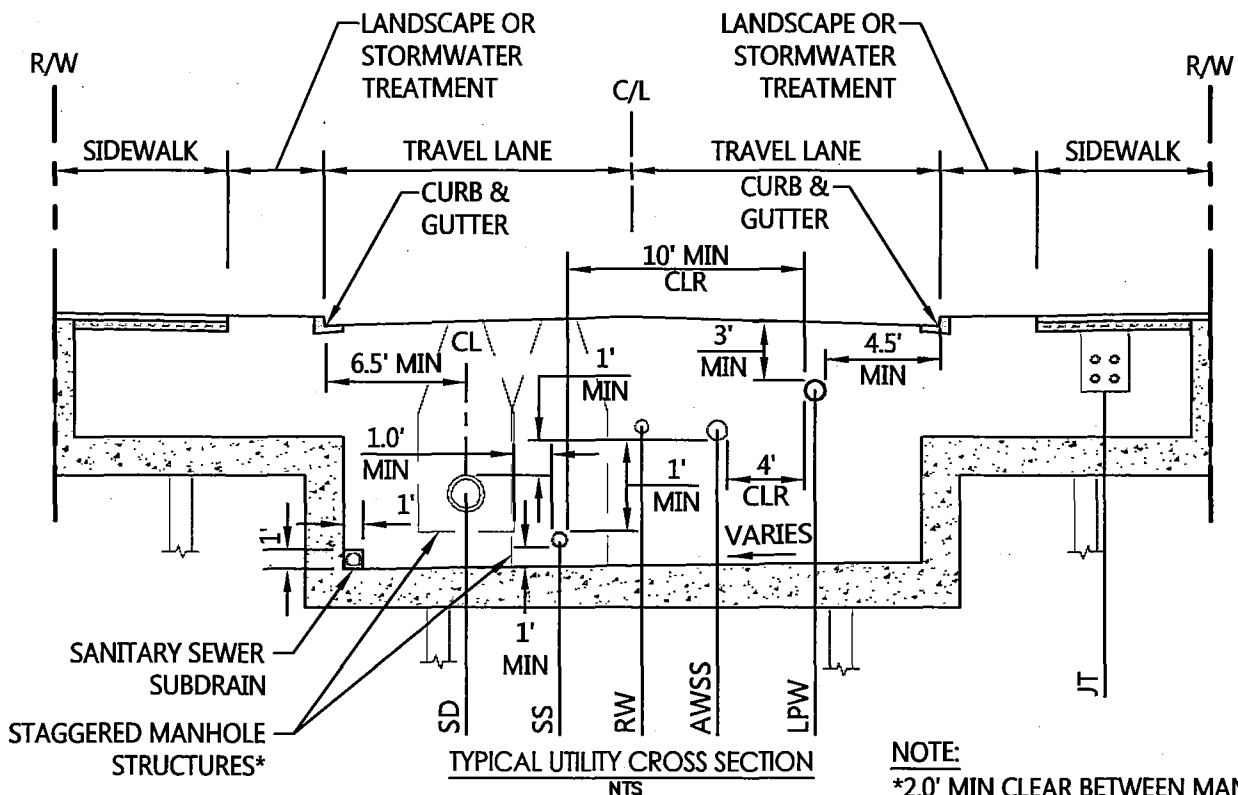

TYPICAL UTILITY CROSS SECTION
NTS

NOTE:
 *2.0' MIN CLEAR BETWEEN MANHOLE STRUCTURES, 1.0' MIN CLEAR FROM PIPE OD TO OUTSIDE MANHOLE STRUCTURE

DRAWING NAME: \\BKF-1\1\4\2008\080006_Mission_Rock\ENG\Exhibits\Infrastructure_Plan_Exhibits\Plotted_Sheets\Figure 11.3 Conceptual Fire Hydrant Locations.dwg
 PLOT DATE: 11-14-17
 PLOTTED BY: volk

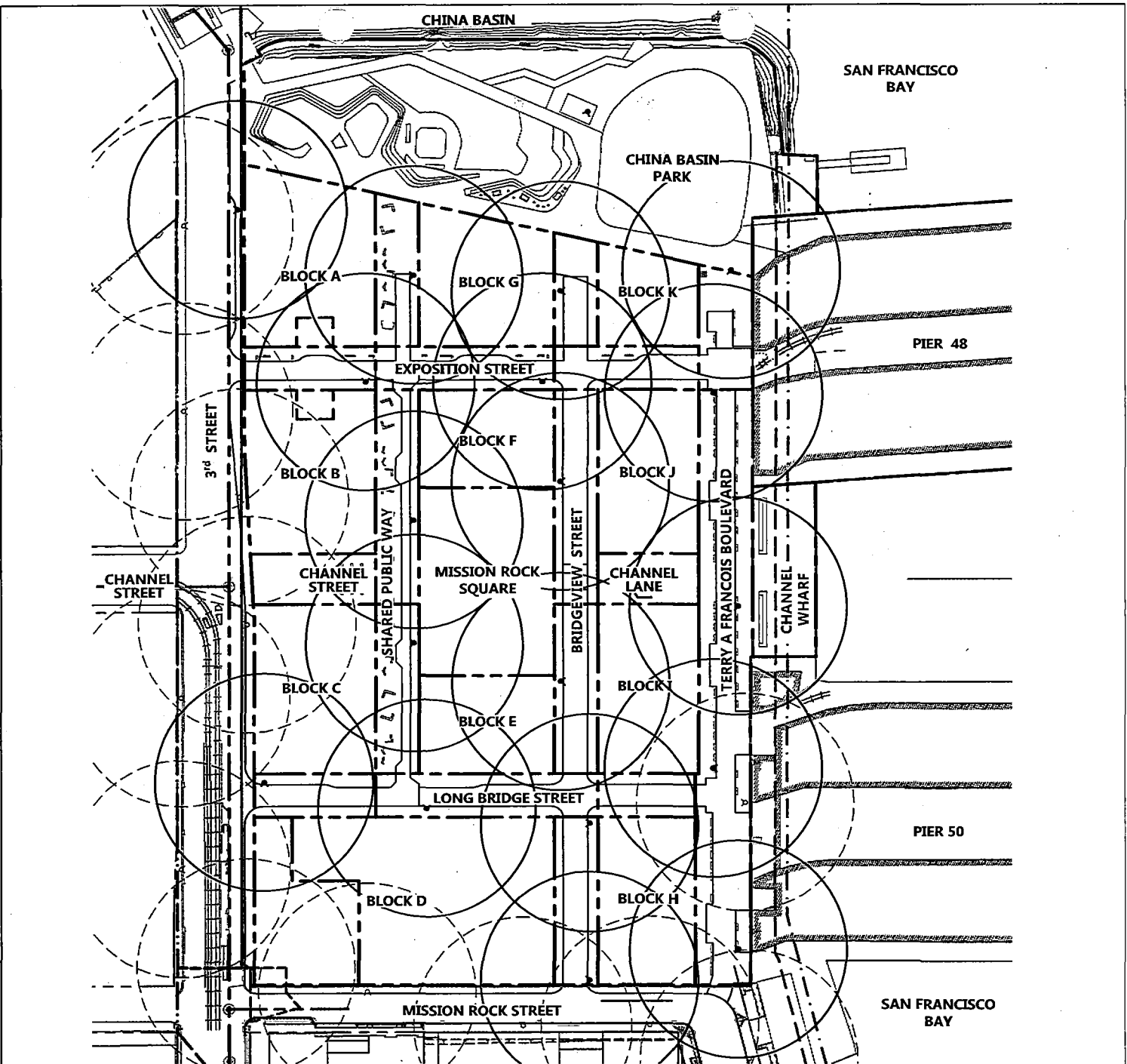

LEGEND

- PROPOSED PARCEL LINE
- - - EXISTING PARCEL LINE
- ▼ PROPOSED LPW FIRE HYDRANT
- ⊕ EXISTING LPW FIRE HYDRANT
- PROPOSED FIRE HYDRANT COVERAGE 150' RADIUS
- EXISTING FIRE HYDRANT COVERAGE 150' RADIUS

ABBREVIATIONS

LPW LOW PRESSURE WATER

Source: BKF ENGINEERS, 07/2016

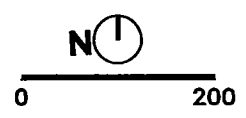

12. SANITARY SEWER SYSTEM

12.1 Existing Sanitary Sewer System

The existing uses of the site include a parking lot and China Basin Park. Although the site does not have existing sanitary sewer facilities, an existing sewer lateral off of Channel Street and 3rd Street was capped after two existing industrial buildings were demolished to build the parking lot.

The existing sanitary sewer infrastructure along the south and west side of the Project site has a separated sewer system. On the east side of the Project, Pier 48 and Pier 50 are served by a 15-inch sanitary storm sewer main that drains to the south within Terry A Francois Boulevard. Sanitary flows within Terry A Francois Boulevard are conveyed to a low spot in the main just south of the intersection at Mission Rock Street where there is an existing sanitary sewer pump station (Port SSPS) owned and maintained by the Port of San Francisco. A 6-inch force main from the Port SSPS at this location lifts sanitary flows into a 12-inch gravity sewer main within Mission Rock Street and is conveyed west into a 15-inch main as it reaches 3rd Street.

Existing separated sanitary sewer facilities within 3rd Street include an 8-inch main north of Channel Street which connects into a 21-inch main in between Channel Street and Mission Rock Street. The flows from the 21-inch main in 3rd Street and the 15-inch main in Mission Rock Street converge at the intersection of 3rd Street and Mission Rock Street and are conveyed through gravity sewer mains to Sanitary Sewer Pump Station #3 at Park 15 and ultimately conveyed to the San Francisco Southeast Treatment Plant prior to treatment and discharge to the Bay.

12.2 Proposed Sanitary Sewer System

12.2.1 Proposed Sanitary Sewer Demands

The Project sanitary sewer demands conservatively assume 95% return on potable water demands and 100% return on recycled water demands for ADD, resulting in an Average Daily Dry Weather Flow (ADWF) of approximately 312,668 gallons per day (gpd) or 217 gallons per minute (gpm) over 24-hours. Including an infiltration rate of 0.003 cubic feet per second per acre and applying a peaking factor of 3, the Project is anticipated to generate a Peak Wet Weather Flow (PWWF) of 978 gallons per minute (gpm). The Project's methods for calculating the flow demands will be outlined in the Sanitary Sewer Master Utility Plan (SSMP).

12.2.2 Proposed Sanitary Sewer Capacity

Sanitary sewer models for the Project have been developed to confirm the sanitary sewer system designs and capacity, and will be included in the SSMP. The Project proposes to direct all new sanitary sewer flows, with the exception of Block H & Block I, to the existing 21-inch sanitary sewer main in 3rd Street. Capacity of the existing 21-inch sanitary sewer main in 3rd Street is adequate to serve these demands, which is accounted for in the Mission Bay Master Plan. Block H & Block I sanitary sewer demands will be directed to the existing 12-inch sanitary sewer main in Mission Rock Street. An analysis of the impacts of the Project demands on the existing upstream and downstream infrastructure will be reviewed as part of the SSMP approval process.

The Project proposes to utilize the existing Port SSPS at the corner of Terry A Francois Boulevard and Mission Rock Street to continue serving the existing demands from Pier 48 and Pier 50 which amount to 96 gpm or 138,660 gpd under ADWF conditions and 315 gpm under PWWF conditions. This flow is within the conditions accounted for in the Mission Bay Master Plan. No additional flow resulting from the Project will be directed to the existing Port SSPS at the corner of Terry A Francois Boulevard and Mission Rock Street.

12.2.3 Proposed Sanitary Sewer Design Basis

The proposed sanitary sewer system will be designed in accordance with the City Subdivision Regulations and SFPUC wastewater utility standards. The design basis will be described in greater detail as part of the SSMP.

12.2.4 Proposed Sanitary Sewer Design Criteria

The proposed separated sewer system is intended to convey sanitary sewer flow from the Project. The physical and capacity design criteria for the sanitary sewer system are presented in Table 12.1.

Table 12.1

Mission Rock Separated Sewer Main Design Criteria

Parameter	Criteria/Value
Pipe material for pipe sizes 6-inch to 21-inch inside diameter	VCP (ASTM C-700 Extra Strength) HDPE with special approval from SFDPW and SFPUC
Manhole spacing	300-feet preferred 350-feet maximum (subject to approval of SFPUC)
Minimum depth of cover for mains	6-feet minimum unless otherwise approved by the SFPUC on a case-by-case basis
Minimum flow velocity (<i>average dry weathersanitary flow</i>)	2 fps
Minimum infiltration intensity	0.003 second feet per acre
Manning's n (roughness coefficient) for proposed pipes	VCP: 0.013 HDPE: 0.010
Maximum Pipe Flow Depth Ratio, d/D (<i>average dry weather sanitary flow</i>)	0.50
Maximum Pipe Flow Depth Ratio, d/D (<i>peak wet weather sanitary flow</i>)	0.8
Sewer Generation ⁽¹⁾	Residential: 54 GPD / capita Commercial/Retail: 0.1 GPD / SF

TABLE 12.1 NOTES:

⁽¹⁾ Assumes 95% return on potable water and 100% return on non-potable water based on until demands from the "Treasure Island, Technical Memorandum, Potable Water" dated April 1, 2016. Sewer generation value subject to SFPUC review and approval in the Master Utility Plan.

VCP = Vitrified Clay Pipe

fps = feet per second

d/D = ratio of the depth of flow (d) to the pipe inside diameter (D)

12.2.5 Proposed Sanitary Sewer Collection System

The proposed sanitary sewer system is identified schematically on Figure 12.1. The sanitary sewer system will be designed and constructed by the Developer. Sanitary sewer designs will be reviewed and approved by the Acquiring Agency. Upon construction completion and improvement acceptance by the Acquiring Agency, the new sanitary sewer system will be maintained and owned by the Acquiring Agency. The proposed system will include sanitary sewer

laterals connected to a new system of 8-inch to 12-inch gravity sanitary sewer mains and a force main downstream of the proposed sanitary sewer pump station.

In addition, a new sanitary sewer pump station for dedication to the SFPUC is proposed adjacent to Exposition Street in either Block A or Block B. An easement, MOU, and/or separate agreement will be recorded for SFPUC facilities on Vertical Development parcels on Port property, including provisions for maintenance access.

The development will connect to the existing sanitary sewer main on 3rd Street at two locations. It is anticipated that the proposed sanitary sewer flows along Exposition Street will be discharged to an existing manhole at the intersection of 3rd Street and Exposition Street by a sanitary sewer force main. The proposed pump station for this sanitary sewer force main will be located in either Block A or Block B. The proposed sanitary sewer flows from Long Bridge Street will connect to existing sanitary sewer main on 3rd Street at a new SFPUC manhole structure.

The remaining proposed development flows from Block H & Block I will be collected by a sanitary sewer main in Bridgeview Street and discharge to the existing sanitary sewer main in Mission Rock Street at a new SFPUC manhole structure.

Consistent with the existing condition, the flows from Pier 48 and Pier 50 will connect to the new sanitary sewer main in Terry A Francois Boulevard and discharge to the existing Port SSPS at the intersection of Terry A Francois Boulevard and Mission Rock Street.

See Figure 12.2 for a typical utility cross-section identifying the approximate sanitary sewer system depth and its horizontal relationship to other adjacent utilities.

12.2.6 Structured Street Drainage

Due to geotechnical constraints, the Project will provide structured street sections which will require subdrains to prevent accumulation of water on the structured street. Subdrains, where required based on the final design of the structured streets, will be provided within the structured streets and open space areas to prevent accumulation of water and will drain via a gravity connection or through a sump pump and force main to the sanitary sewer system. Where a

subdrain is required, a sand trap will be installed in advance of the connection of the SFPUC sanitary sewer main. Ownership, maintenance and acceptance of the subdrains and/or sump pumps will be by the Acquiring Agency subject to the DA, DDA, ICA, or separate MOA or MOU.

12.3 Design Modifications and Exceptions

Proposed pipe slopes and cover are constrained within the Project by the existing adjacent sanitary sewer system infrastructure. The existing adjacent sanitary sewer system does not have adequate depth or cover to provide Subdivision Regulation compliant pipe cover. A minimum cover of 6-feet will be provided on top of mains within public streets, where less than 6-ft of cover is provided, a design modification and exception request for a reduced cover depth of up to 3-feet will be submitted for approval by the Director of Public Works with the consent of the SFPUC during the construction document approval process. Anticipated locations where a design modification and exception requests for reduced pipe cover are shown on Figure 12.3.

With the cover and slope constraints, VCP sanitary sewer mains will not provide adequate flow velocities or capacities. To provide the minimum flow velocity of 2 fps and sufficient flow capacity with the limited available pipe slopes, the Project proposes to install fusion-welded high density polyethylene (HDPE) pipe SDR-17 or better. The HDPE pipe has less friction than VCP and will provide adequate flow velocities and flow capacities. HDPE pipe will be flex tested using Mandrel test. Design modification and exception requests to allow HDPE pipe are subject to the approval of the Director of Public Works with the consent of the SFPUC.

Vertical and horizontal separation distances between adjacent sanitary sewer system, storm drain system, potable water, and dry utilities will conform to the requirements outlined in Title 22 of the California Code of Regulations and the State of California Department of Health Services Guidance Memorandum 2003-02 and the Subdivision Regulations. As shown in Figure 12.2 and described in Section 10, the sanitary sewer mains are proposed to be offset from the center of the street to ensure that adjacent water lines can be placed outside of the proposed bulb-outs while maintaining the required health code separation clearances. Horizontal clearances for proposed sanitary sewer infrastructure are provided in the Section 10 Utility Layouts and Separations. Design modification and exception requests to allow for alternative pipe locations are subject to the approval of the Director of Public Works with the consent of the SFPUC.

12.4 Phases for Sanitary Sewer System Construction

The Developer will design and install the new sanitary sewer system based on the principle of adjacency and as-needed to facilitate a specific proposed Development Phase and consistent with the requirements of the DA, DDA and ICA. The amount and location of the proposed sanitary sewer systems installed will be the minimum necessary to support the Development Phase. The new Development Phase will connect to the existing systems as close to the edge of the Development Phase area as possible while maintaining the integrity of the existing system for the remainder of the Project. Repairs and/or replacement of the existing Infrastructure necessary to support the proposed Development Phase will be designed and constructed by the Developer. Interim sanitary sewer systems connecting to SFPUC or Port owned infrastructure will be owned, constructed and maintained by the Developer as necessary to maintain existing sanitary sewer facilities impacted by proposed Development Phases. The Developer will own and maintain interim facilities, as required, until completion of the Development Phase or until the infrastructure is no longer functionally required and has been removed.

The Port and City are responsible for maintenance of the existing Port and City sanitary sewer facilities, respectively. The Acquiring Agency will be responsible for the proposed sanitary sewer system once construction of the horizontal improvements for Development Phase or new sanitary sewer system is complete and accepted by the Acquiring Agency. The Developer will be responsible for mitigating impacts to Infrastructure installed with previous Development Phases of the Project due to the designs or construction of new Development Phases and will be addressed prior to approval of the construction drawings for the new Development Phase. Pipes and manholes adjacent to a new Development Phase must undergo inspection before and after construction of the new Development Phase. For each Development Phase and concomitant with the submittal of construction documents, the Developer will provide a phase-specific Sanitary Sewer System Utility Report describing and depicting the existing and proposed sanitary sewer infrastructure, and demonstrating that the Development Phase will provide sanitary sewer infrastructure capable of serving the Development Phase to the standards of the Acquiring Agency.

12.4.1 Existing Sanitary Sewer System Demolition Phasing

The existing sanitary sewer system adjacent to the site along 3rd Street and Mission Rock Street will remain. The existing on-site 15-inch combined sewer main is located in Terry A Francois Boulevard east of Seawall Lot 337 and connects to the existing sanitary sewer manhole at the

intersection of Mission Rock Street and Terry A Francois Boulevard. The portion of this main that along the frontage of Pier 48 and Pier 50 will remain to provide service to the Piers. This main is proposed to be replaced with a 12-inch separated sanitary sewer system during the redevelopment of Terry A Francois Boulevard. New connections will be provided to Pier 48 and Pier 50 branching from the new main.

DRAWING NAME: K:\2006\080000\Mission Rock\ENG\Exhibits\Infrastructure Plan Exhibits\Plotted Sheets\Figure 12.1 Conceptual Sanitary Sewer System.dwg
 PLOT DATE: 11-09-17
 PLOTTED BY: halj

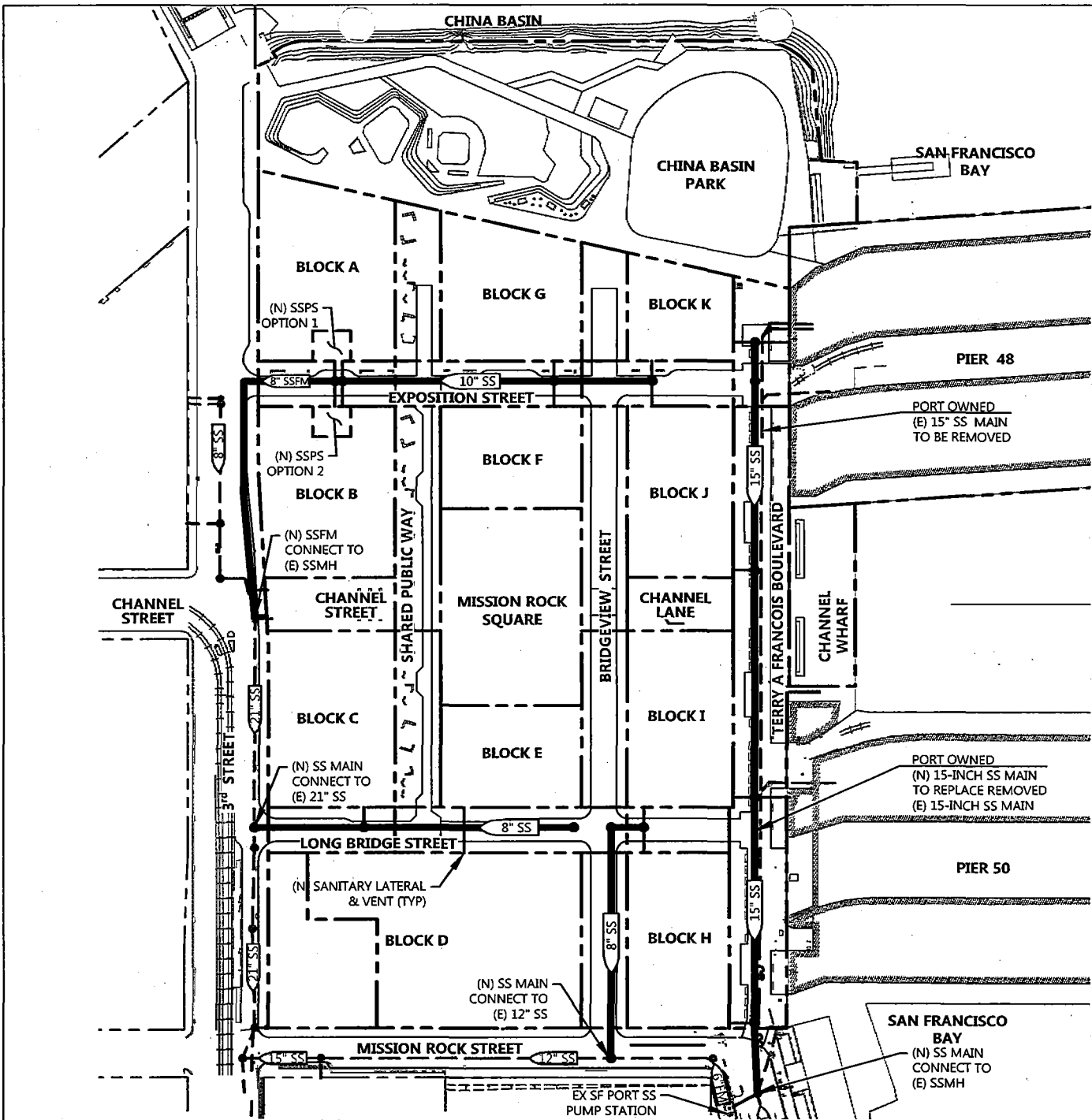

LEGEND

- PROPOSED PARCEL LINE
- - - EXISTING PARCEL LINE
- PROPOSED SANITARY SEWER LINE (8" HDPE & 12" HDPE)
- - - EXISTING SANITARY SEWER LINE
- PROPOSED SANITARY SEWER MANHOLE
- EXISTING SANITARY SEWER MANHOLE
- ◀ 12" SS PIPE SIZE AND FLOW DIRECTION

Source: BKF ENGINEERS, 07/2016

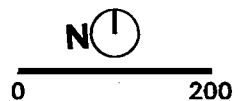

DRAWING NO: 11-13-17
 PLOTTED BY: volk
 SOURCE: BRK ENGINEERS, 07/2018

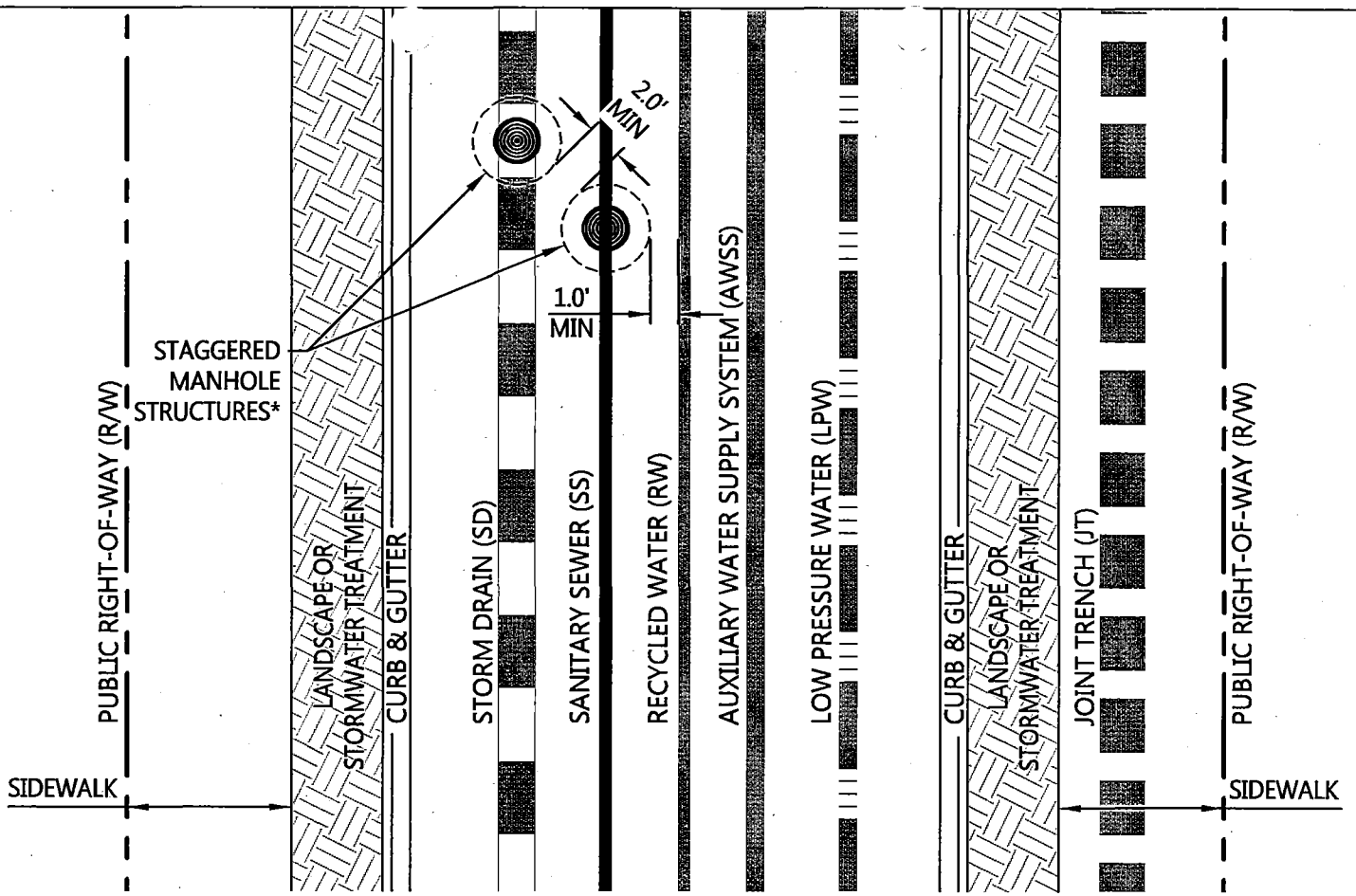

TYPICAL STREETS
 NTS

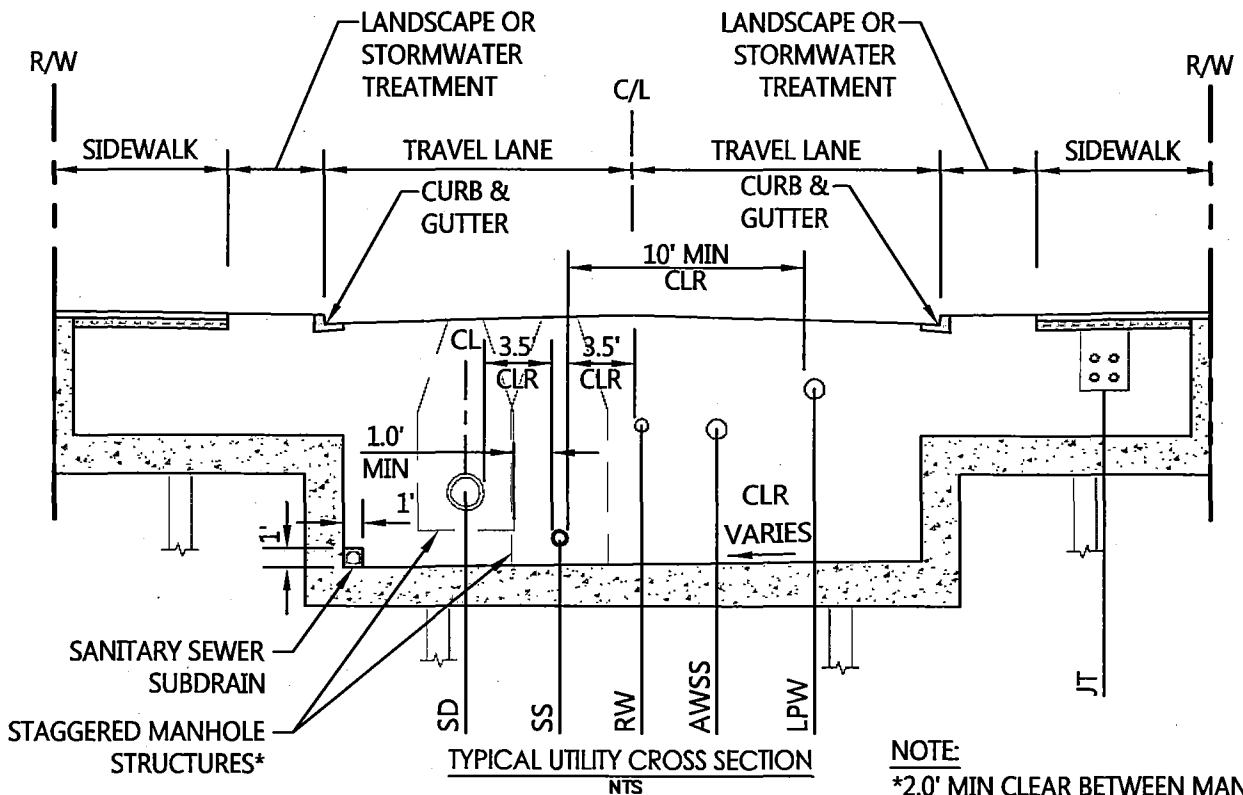

TYPICAL UTILITY CROSS SECTION
 NTS

NOTE:
 *2.0' MIN CLEAR BETWEEN MANHOLE STRUCTURES, 1.0' MIN CLEAR FROM PIPE OD TO OUTSIDE MANHOLE STRUCTURE

DRAWING NAME: K:\2008\080000\Mission Rock\ENG\Exhibits\Infrastructure Plan Exhibits\Plotted Sheets\Figure 12.3 Sanitary Sewer Variance Request Locations.dwg
 PLOT DATE: 11-08-17
 PLOTTED BY: hal

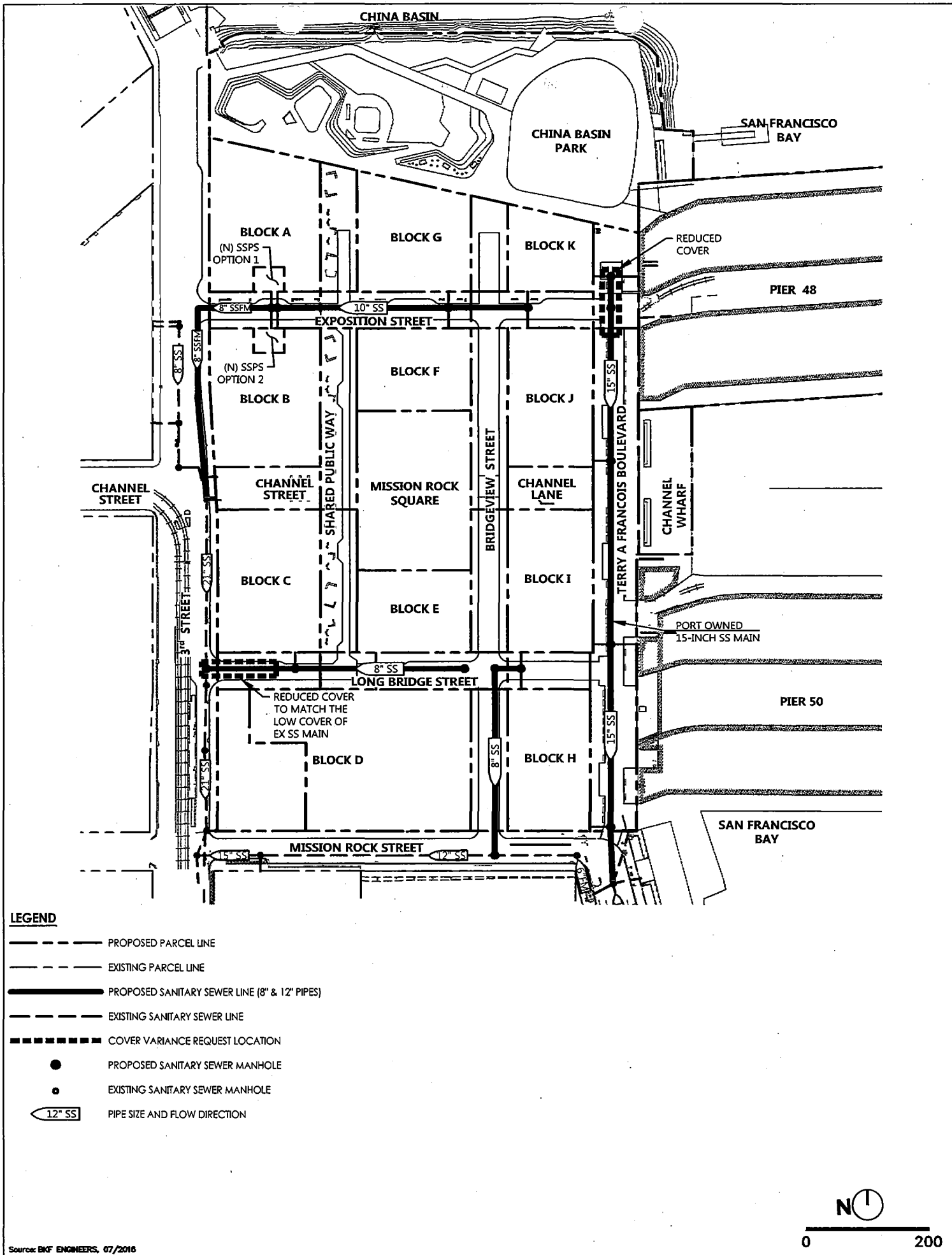

MISSION ROCK INFRASTRUCTURE PLAN

FIGURE 12.3 - SANITARY SEWER VARIANCE REQUEST LOCATIONS

13. STORM DRAIN SYSTEM

13.1 Existing Storm Drain System

The existing storm drain infrastructure within the vicinity of the Project site has a separated storm drain system to the west, south, and east, and two separate Port-owned outfalls that drain to the San Francisco Bay. The west side of the Project is served by an existing separated storm drain system within 3rd Street that is routed to the future Mission Bay Stormwater Pump Station (SWPS) #3 for discharge to Mission Creek. Until SWPS #3 is constructed, stormwater flows continue past SWPS #3 into an existing 11' x 11' combined sewer box that drains to the existing Channel Street Pump Station. The re-aligned Mission Rock Street to the south has a new separated storm drain system that conveys stormwater to Mission Bay SWPS #6 to the south that discharges to the San Francisco Bay adjacent to the Radiance Development and Block P18. Both China Basin Park and Terry A Francois Boulevard have storm drain systems that discharge directly to the San Francisco Bay through existing Port-owned outfalls. The existing Pier 48 and Pier 50 structures have a separated storm drain system that discharge directly to the Bay from the piers.

Storm drain system capacities within the existing 42 inch storm drain system in 3rd Street and the 21-inch storm drain main in Mission Rock Street are adequate to serve the tributary drainage areas from the Project. As described in the Draft Drainage Report for Mission Bay Drainage Area D (September, 2012), the existing storm drain system provides the minimum freeboard requirement for a 5-year storm event. Pump station designs have also been sized to meet the 5-year storm event requirements and are summarized in The Basis of Design Mission Bay Stormwater Pump Station #3 Draft Report (May, 2009).

13.2 Conceptual Storm Drain System Design

13.2.1 Overview

The Project will replace the existing on-site storm drain system with new storm drain systems connecting into the existing separated storm drain systems serving the site. The proposed separated storm drain system will be designed in accordance with the Subdivision Regulations and the Stormwater Management Requirements and Design Guidelines (SMR) and other SFPUC wastewater standards, where applicable. The on-site storm drain system will be designed to convey the stormwater runoff from the 5-year storm event from the development parcels and streets. For the 100-year storm and overland release, the storm drain system, street section, and street grading will be designed to convey the stormwater runoff from the Development Parcels

and streets. A more detailed analysis will be included in the Grading and Storm Drain System Master Utility Plan.

13.2.2 Storm Drain Design Criteria

As documented in the Subdivision Regulations and the SFPUC utility standards, as appropriate, proposed 6-inch to 21-inch pipes will be constructed from ASTM C-700 Extra Strength Vitrified Clay Pipe (VCP). Main extensions for 36-inch pipes or larger shall require monolithic reinforced concrete or reinforced concrete pipe subject to approval by the Director with consent of the SFPUC.

Proposed Acquiring Agencies' storm drain mains within the Project will be constructed on approved crush rock bedding. The minimum residential and commercial service lateral size is 6-inches and 8-inches, respectively. Manhole covers will be solid with manhole spacing set at a maximum distance of 300-feet and at changes in size, grade or alignment. Stormwater inlets will be installed per the Subdivision Regulations or SFPUC wastewater utility standards and outside of the curb returns crosswalks, accessible passenger loading zones and accessible parking spaces, where feasible. Linear Drainage Elements within the bike and pedestrian zones of TFB and SPW will be installed to be ADA compliant, and meet the modeling requirements described in Section 13.3.3 below.

Storm drain system capacities within the existing 42-inch storm drain system in 3rd Street and the 21-inch storm drain main in Mission Rock Street are adequate to serve the entire buildout of the project. A minimum depth of cover of 6-feet will be required on top of storm drain mains within new public streets. A freeboard of 4-feet below pavement or ground will be required to conform to the Subdivision Regulations or SFPUC utility standards. If necessary, an alternative minimum cover of 4-feet and/or minimum freeboard of 2-feet below pavement or ground may be permitted by the Acquiring Agency, or if accepted by the City, the Director of Public Works with the consent of the SFPUC or Port.

Vertical and horizontal separation distances between adjacent sanitary sewer system, storm drain system, LPW infrastructure, district utilities, and dry utilities will conform to the requirements outlined in Section 10 and the Subdivision Regulations.

13.2.3 Conceptual Storm Drain System Layout

The conceptual storm drain system is identified schematically on Figure 13.1. The storm drain system will be designed and constructed by the Developer. Street storm drains including street drainage within the new public rights-of-way will be reviewed and approved by the Acquiring Agency. The new storm drain system will be maintained and owned by the Acquiring Agency, upon construction completion and improvement acceptance by the Acquiring Agency. The proposed system will include storm drain laterals connected to a system of 12-inch to 42-inch SFPUC gravity storm drain mains.

The conceptual storm drain system will connect to the existing storm drain systems at up to seven locations. Along 3rd Street, the on-site storm drain system will connect to an existing SFPUC 42-inch main through proposed manhole structures at Exposition Street, Channel Street, Long Bridge Street, China Basin Park, and the west half of Block D. The storm drain system within Terry A Francois Boulevard will drain to a treatment pump conveying treatment flows to the proposed parks for treatment. For larger storm events, Terry A Francois Boulevard will connect into an existing Port 30-inch outfall that drains to the San Francisco Bay between Pier 48 and Pier 50. As part of the project, the outfall will be upgraded or replaced and dedicated to the SFPUC, along with a required access and maintenance easement. China Basin Park storm drain system will connect into an existing 12-inch Port outfall draining to China Basin for discharge of treated stormwater. . Refer to Section 16 for a description of the conceptual stormwater treatment strategy for the Project

Refer to Figure 13.2 for the approximate storm drain system depth and its relationship to other adjacent utilities. The storm drain infrastructure layout and locations will be approved during the Project construction document review process.

13.3 Storm Drain System Design Modifications and Exceptions

Design modification and exception requests are anticipated for, but not limited to, the following storm drain infrastructure items, which will be subject to the approval of the Director of Public Works with the consent of the SFPUC, or other Acquiring Agency:

13.3.1 Pipe Material

The Project proposes to install HDPE pipe SDR-17 or better and associated trenching requirements in place of VCP. The HDPE pipe has less friction than VCP, is more flexible, can better accommodate minor amounts of settlement, and will provide adequate flow velocities and capacities. In addition, HDPE pipe will be flex tested using the Mandrel test.

13.3.2 Freeboard and Cover

Due to existing conditions and constraints within the Project site and at conforms to the existing City-accepted public rights-of-way at 3rd Street and Mission Rock Street, exceptions to the standard layout of utilities will be requested during design development. A design modification and exception will be requested to allow for a reduced minimum cover of 4-feet on top of the storm drain system infrastructure. In addition, initial modeling for the 5-year storm design analysis indicates that the conceptual storm drain system was only able to provide a minimum hydraulic grade line (HGL) of 2-feet of freeboard below the pavement or ground surface at select proposed connection points due to existing high starting HGL elevations at existing storm drains.

13.3.3 Linear Drainage Infrastructure on Curbless and Flush Curb Streets

Terry A Francois Boulevard, SPW, and the northern segment of Bridgeview Street will be designed without curbs or with flush curbs in combination with an inverted crown. To accommodate the project design approach, a linear drainage element, including but not limited to a valley gutter, inverted crown street or trench drains, in combination with inlets at low points will be incorporated at or along the flowline to provide drainage. Linear drainage elements are proposed along the theoretical face of curb of the curbless streets, which represents the location in which a curb would typically be installed if included as part of the street design. These linear drainage elements will be rated to handle heavy vehicle (H20) traffic loading. Drainage from linear drainage elements will be conveyed to the storm drain. Performance modeling of grading and hydrology designs along streets with no curbs or with flush curb will be developed during the MUP approval process in conformance with the requirements of the Acquiring Agency.

13.3.4 Storm Drainage Infrastructure on Curbless and Flush Curb Streets

The clear street width is 20 feet on SPW, which does not provide adequate width for the horizontal layout of District Energy pipes, a non-potable water main, a low pressure water main, and a storm drainage main. Thus, the Project proposes to locate the storm drainage main underneath the edge

of the clear travel way and beneath the linear drainage element. If the SFPUC and City do not accept the infrastructure, then the Acquiring Agency will be the Port. This will be documented in the Ownership and Maintenance Matrix included as part of the DA, DDA, ICA, or a separate MOU/MOA between the Port, City and Developer.

Storm Drain lateral responsibility would be assigned to the property owner if the adjacent development parcel requiring a lateral from TFB, SPW, or the northern segment of Bridgeview Street. This will be documented in the Ownership and Maintenance Matrix included as part of the DA, DDA, ICA, or a separate MOU/MOA between the Port, City and Developer.

13.4 Phases for Storm Drain System Construction

The Developer will design and install the new storm drain system based on the principle of adjacency and as-needed to facilitate a specific proposed Development Phase and consistent with the requirements of the DA, DDA, and ICA. The amount and location of the proposed storm drain systems installed will be the minimum necessary to support the Development Phase. The new Development Phase will connect to the existing systems as close to the edge of the Development Phase area as possible while maintaining the integrity of the existing system for the remainder of the Project. Repairs and/or replacement of the existing facilities necessary to support the proposed Development Phase will be designed and constructed by the Developer. Interim storm drain systems will be constructed, owned, and maintained by the Developer as necessary to maintain existing drainage facilities impacted by proposed Development Phases. The Acquiring Agency may inspect interim facilities owned by the Developer or Port subject to the DA, DDA, ICA, or separate MOU/MOA between the Port, City, and Developer.

The Port and City will be responsible for ownership and maintenance of existing Port or City owned storm drain facilities, respectively. The Acquiring Agency will own and maintain the proposed storm drainage facilities once construction of the Horizontal Improvements required for a Development Phase or a new storm drain facility is complete and accepted by the Acquiring Agency subject to the DA, DDA, ICA, or a separate MOU/MOA between the Port, City and Developer. The Developer will be responsible for mitigating impacts to Infrastructure improvements installed with previous Project Development Phase(s) due to the designs or construction of current or future Development Phases, which will be addressed prior to approval of the construction drawings for the current or future Development Phase. For each Development Phase and concurrent with the submittal of construction documents, the Developer will

provide a phase-specific Storm Drain System Utility Report describing and depicting the existing and proposed storm drain infrastructure, and demonstrating the that Development Phase will provide drainage infrastructure capable of serving the Development Phase to the standards of the Acquiring Agency. This will be documented in the Ownership and Maintenance Matrix included is part of the DA, DDA, ICA, or a separate MOU/MOA between the Port, City and Developer.

DRAWING NAME: \\dk1-sf\vo14\2008\080000\Mission Rock\ENG\Exhibits\Infrastructure Plan Exhibits\Plotted Sheets\Figure 13.1 Conceptual Storm Drainage System.dwg
 PLOT DATE: 11-13-17
 PLOTTED BY: voik

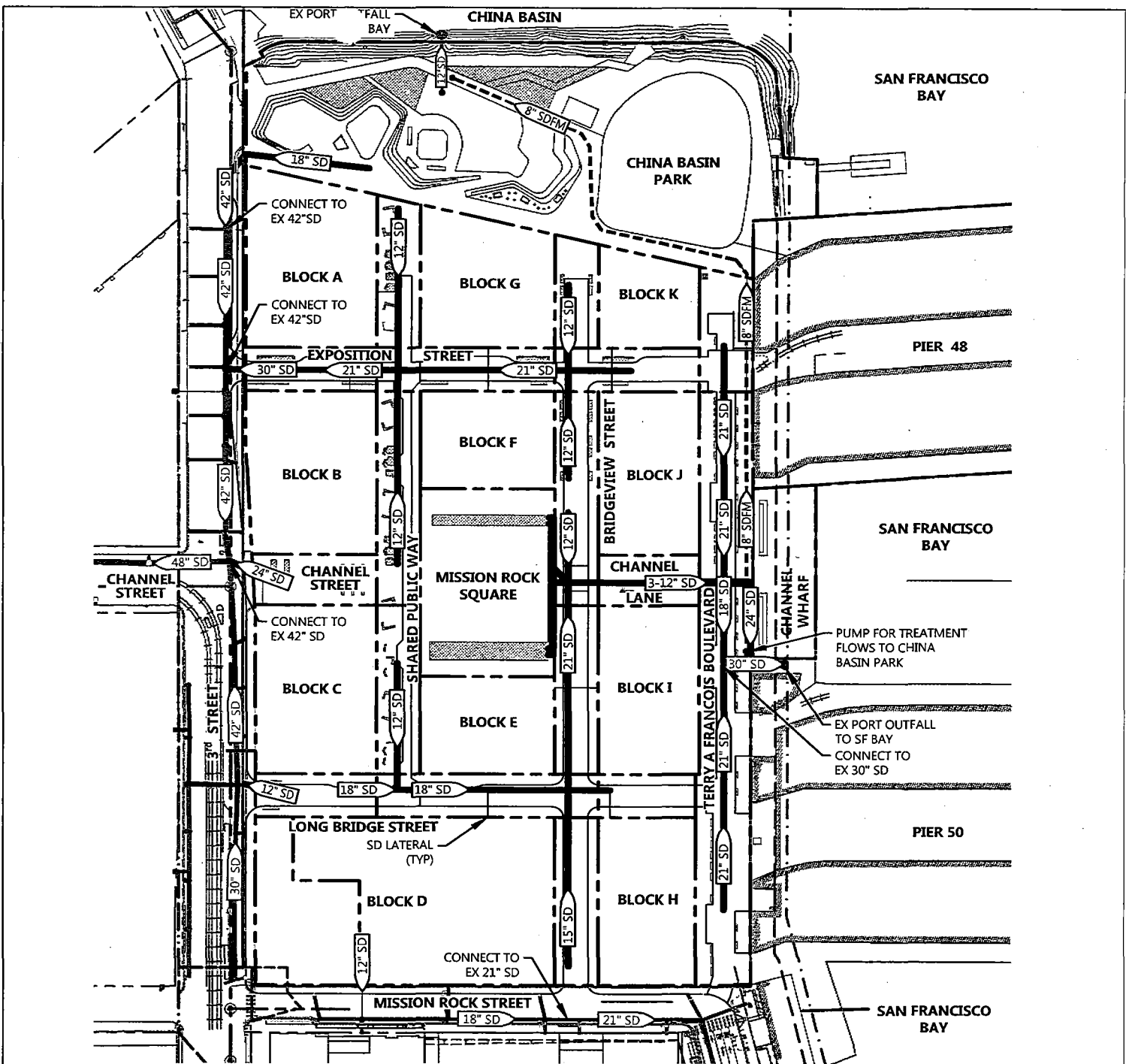

LEGEND

- PROPOSED PARCEL LINE
- - - EXISTING PARCEL LINE
- 12" SD --- EXISTING STORM DRAIN MAIN
- 12" SD --- PROPOSED STORM DRAIN MAIN
- 8" SDFM --- PROPOSED STORM FORCE MAIN
- EXISTING STORM DRAIN MANHOLE
- PROPOSED STORM DRAIN MANHOLE
- ▨ BIORETENTION AREA

Source: BRF ENGINEERS, 07/2016



DRAWING NAME: \\011-SF\vol14\2008\080008_Mission Rock\ENG\Exhibits\Infrastructure Plan Exhibit\Plotted Sheets\Figure 11.2_14.2 Typical Utility Section.dwg
 PLOT DATE: 11-13-17
 PLOTTED BY: volk

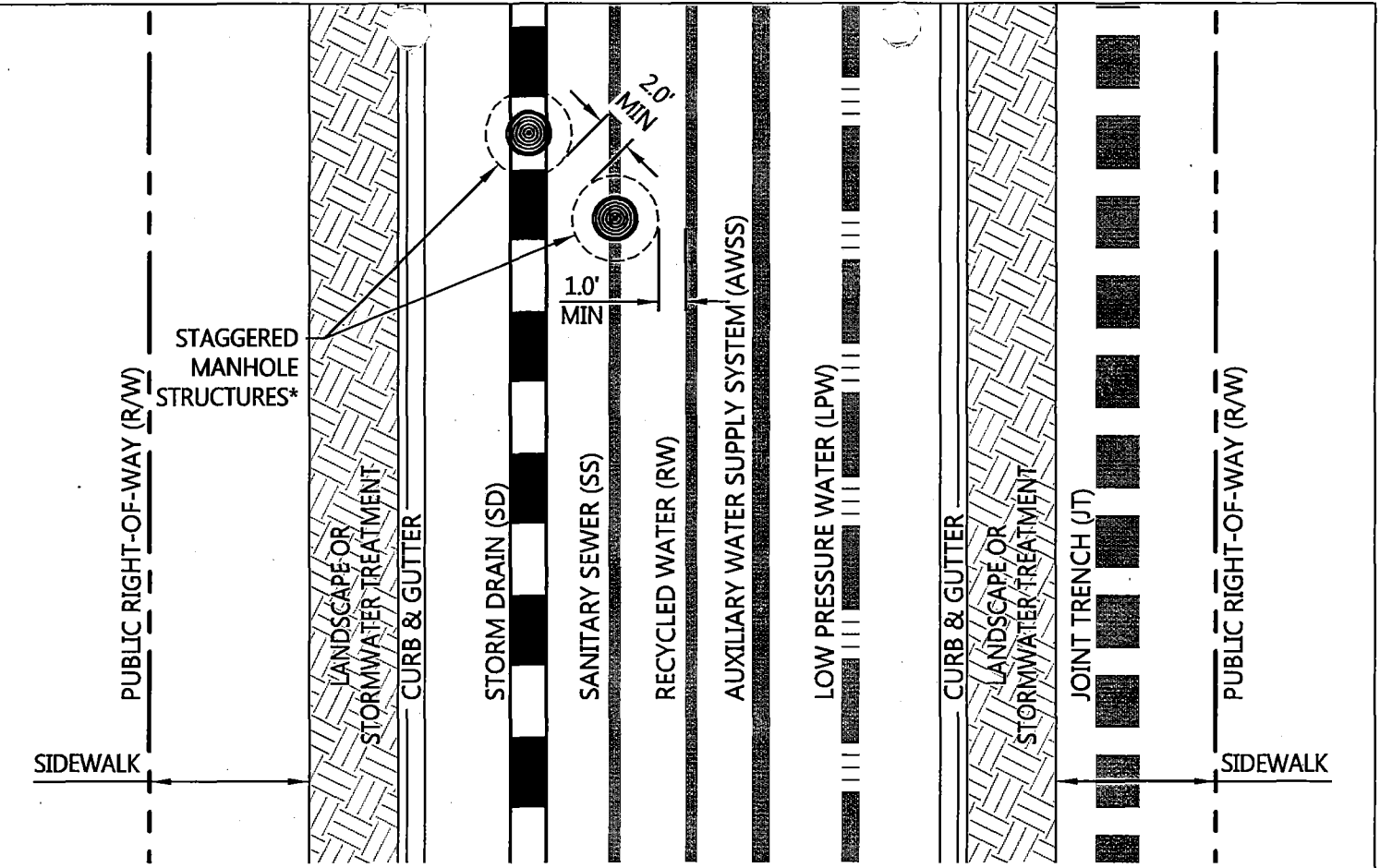

TYPICAL STREETS
NTS

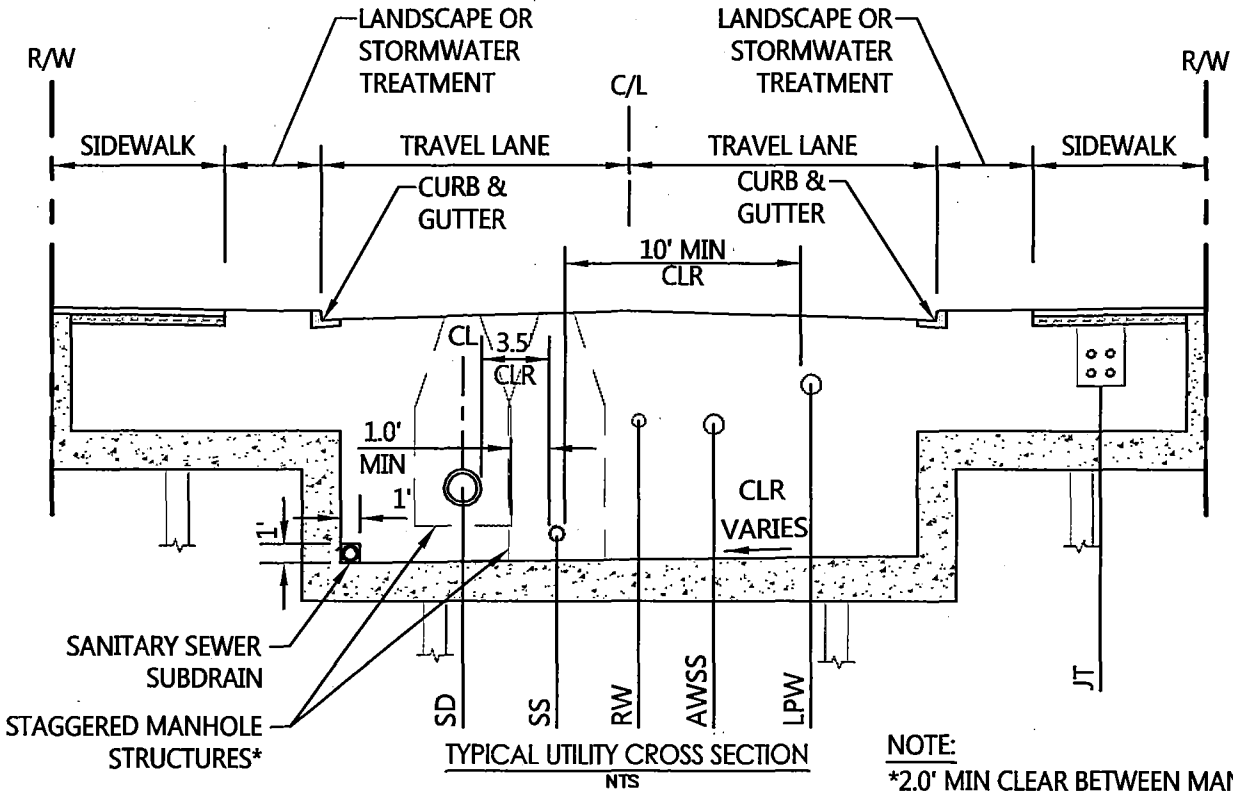

TYPICAL UTILITY CROSS SECTION
NTS

NOTE:
 *2.0' MIN CLEAR BETWEEN MANHOLE STRUCTURES, 1.0' MIN CLEAR FROM PIPE OD TO OUTSIDE MANHOLE STRUCTURE

14. AUXILIARY WATER SUPPLY SYSTEM (AWSS)

14.1 Existing AWSS Infrastructure

The San Francisco Public Utilities Commission (SFPUC), in cooperation with the San Francisco Fire Department (SFFD), owns and operates the Auxiliary Water Supply System (AWSS), a high-pressure non-potable water distribution system dedicated to fire suppression that is particularly designed for reliability after a major seismic event. Currently, a 12-inch AWSS main exists adjacent to the Project site on 3rd Street between Channel Street and Mission Rock Street.

14.2 AWSS Regulations and Requirements

New developments must meet the fire suppression objectives that were developed by the SFPUC and SFFD. The SFPUC and SFFD will work with the Developer to determine post-seismic fire suppression requirements during the planning phases of the Project. Requirements will be determined based on building density, fire flow and pressure requirements, City-wide objectives for fire suppression following a seismic event, and proximity of new facilities to existing AWSS facilities. AWSS improvements will be located in public rights-of-way or on City property, as approved by SFPUC. Easements required to place AWSS infrastructure on Port property are subject to the approval of the Port and SFPUC.

14.3 Conceptual AWSS Infrastructure

To meet the SFPUC and SFFD AWSS requirements, the development may be required to incorporate infrastructure and facilities that may include, but are not limited to:

- Seismically reliable high-pressure water piping and hydrants with two points of connection. One connection is proposed at the existing 12-inch AWSS distribution system in 3rd Street near the Exposition Street intersection, and a second connection is proposed to a future AWSS facility at the Mission Rock Street and Terry A Francois Boulevard intersection;
- Independent network of seismically reliable low-pressure piping and hydrants with connection to existing potable water distribution system at location that is determined to be seismically upgraded by SFPUC;
- Saltwater pump station that supplies saltwater to AWSS distribution piping following a major seismic event;
- Piping manifolds along waterfront that allow fire trucks to access and pump sea or bay water for fire suppression; and/or
- Potable water supply system (PWSS), including long reaches of hose and equipment mounted

on dedicated trailers or trucks.

- Cisterns

Based on coordination with the SFPUC, the Project proposed locations and types of AWSS infrastructure are identified schematically on Figure 14.1 and approximate AWSS main depths and its relationship to other adjacent utilities are shown on Figure 14.2. AWSS fire hydrants are provided at street intersections within the Project site. In addition, the project includes an extension of the AWSS system down Terry A Francois Boulevard from Long Bridge Street to the Mission Rock Street-Terry A Francois Boulevard intersection for a connection to the future AWSS facility on Terry A. Francois Boulevard that will extend from South Street to Mission Rock Street. Where the AWSS facility is proposed to be installed in the Terry A Francois Boulevard right-of-way, the AWSS infrastructure will be placed beneath the 16-ft wide and clear zone beneath the Blue Greenway, which exceeds the 12-ft minimum clear access width for Gate Trucks required by SFPUC. Final designs of the AWSS solution for the Project site will be determined by the SFPUC and SFFD in consultation with the Developer based on equivalent infrastructure costs of the proposed AWSS layout and infrastructure as shown on Figure 14.2, and a capital contribution not to exceed \$1,500,000 current dollars, subject to a 4.5% escalation calculated from the time of project approval, to support off-site AWSS infrastructure per the terms of the DA, DDA, and/or ICA.

14.4 Phases for AWSS Construction

The Developer will design and install the new AWSS based on the principle of adjacency and as-needed to facilitate a specific proposed Development Phase and consistent with the requirements of the DA, DDA and ICA. The amount and location of the proposed AWSS installed will be the minimum necessary to support the Development Phase. The new Development Phase will connect to the existing systems as close to the edge of the Development Phase area as possible while maintaining the integrity of the existing system for the remainder of the Project. Repairs and/or replacement of the existing facilities necessary to support the proposed Development Phase will be designed and constructed by the Developer.

The SFPUC will be responsible for the new AWSS facilities once construction of the improvements is complete, and the facilities are accepted by the SFPUC. Impacts to improvements installed with previously constructed portions of the development due to the designs of other Development Phases will be the

responsibility of the Developer and addressed prior to approval of the construction drawings for the new Development Phase.

14.4.1 AWSS Phased Installation

The Mission Rock AWSS will be installed within the phased structured streets, 3rd Street and Terry A Francois Boulevard. The existing AWSS adjacent to the site along 3rd Street will remain in place. The new system will connect to the existing SFPUC system at the adjacent existing AWSS main along 3rd Street.

For each Development Phase, the SFPUC, in conjunction with its consultants, will provide an AWSS Report describing and depicting the pressures and flows the AWSS provides with the Phase. The construction documents and installation of AWSS infrastructure will be completed by the Developer in coordination with the SFPUC.

DRAWING NAME: \\BKF-1\vol14\2008\000006\Mission Rock\ENG\Exhibits\Infrastructure Plan Exhibits\Plotted Sheets\Figure 14.1 Conceptual Auxiliary Water Supply System.dwg
PLOT DATE: 11-14-17
PLOTTED BY: volk

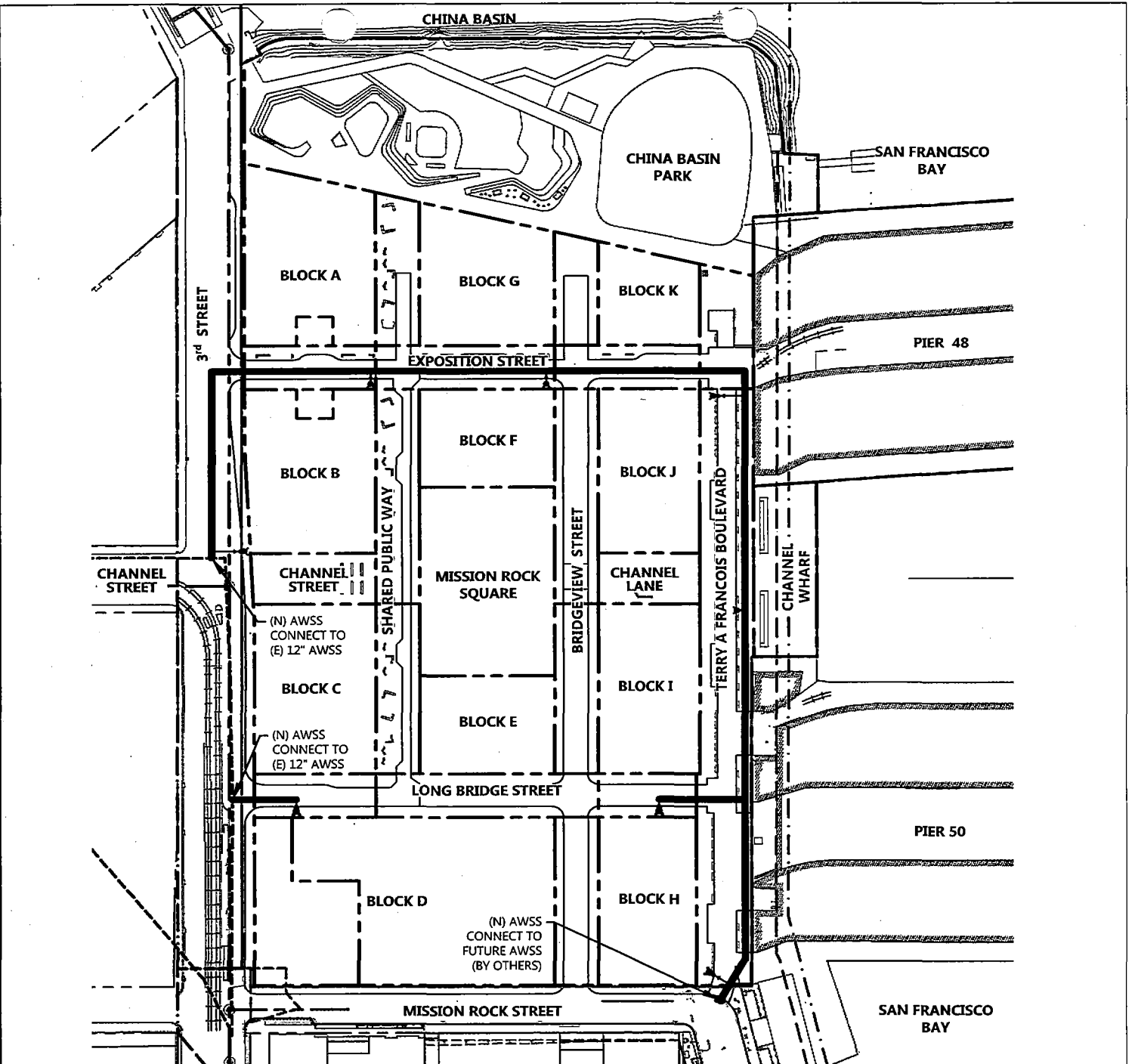

LEGEND

- PROPOSED PARCEL LINE
- EXISTING PARCEL LINE
- PROPOSED AWSS LINE
- EXISTING AWSS LINE
- AWSS FIRE HYDRANT, LATERAL, AND VALVE

LEGEND

AWSS - AUXILIARY WATER SUPPLY SYSTEM

Source: BKF ENGINEERS, 07/2016

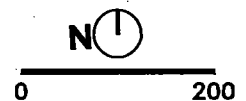

DRAWING NAME: \\bkt-sf\vol1\2008\080000_Mission Rock\ENR\Exhibit\Infrastructure Plan Exhibit\Plotted Sheet\Figure 11.2_14.2 Typical Utility Section.dwg
 PLOT DATE: 11-13-17
 PLOTTED BY: volk

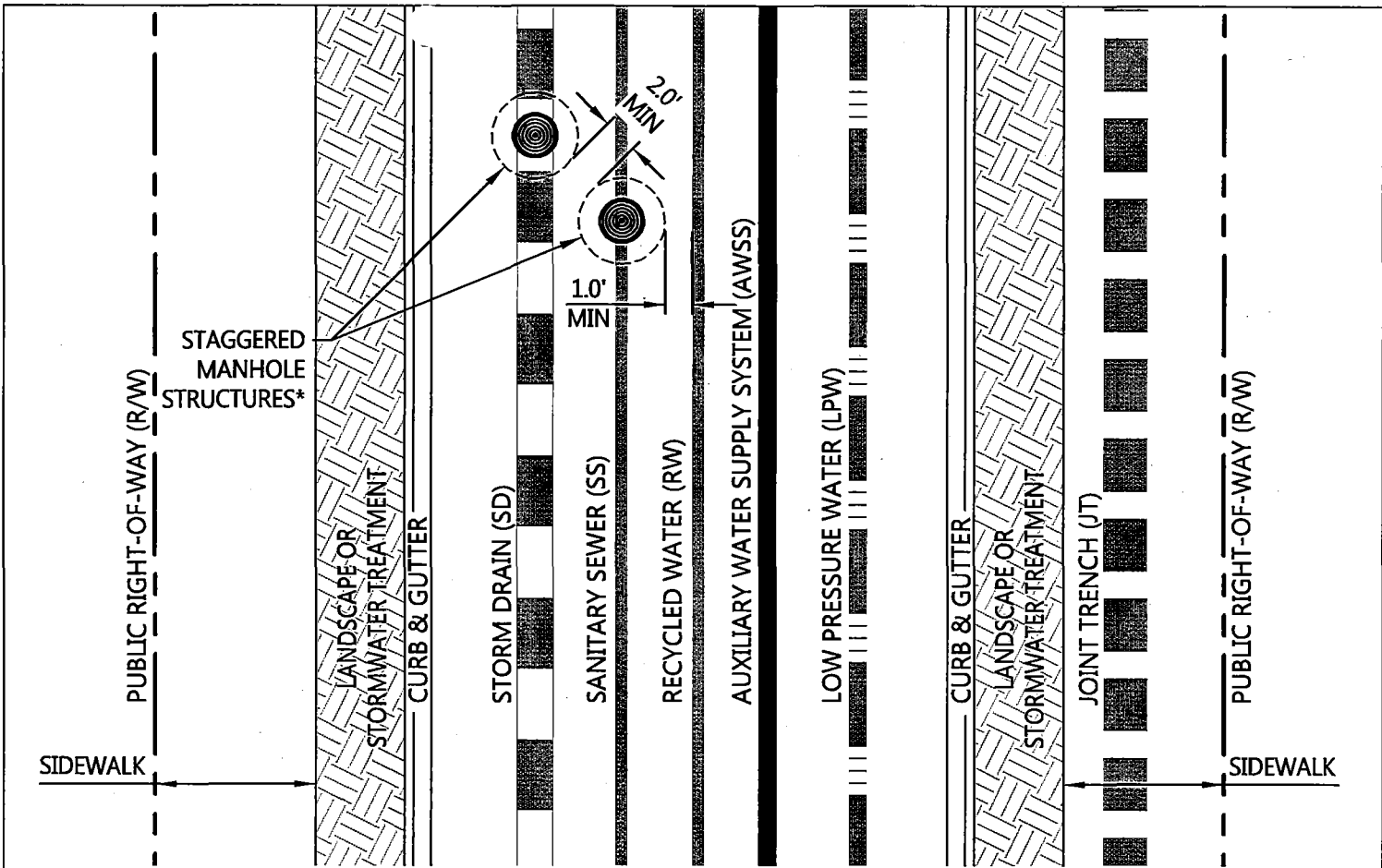

TYPICAL STREETS
NTS

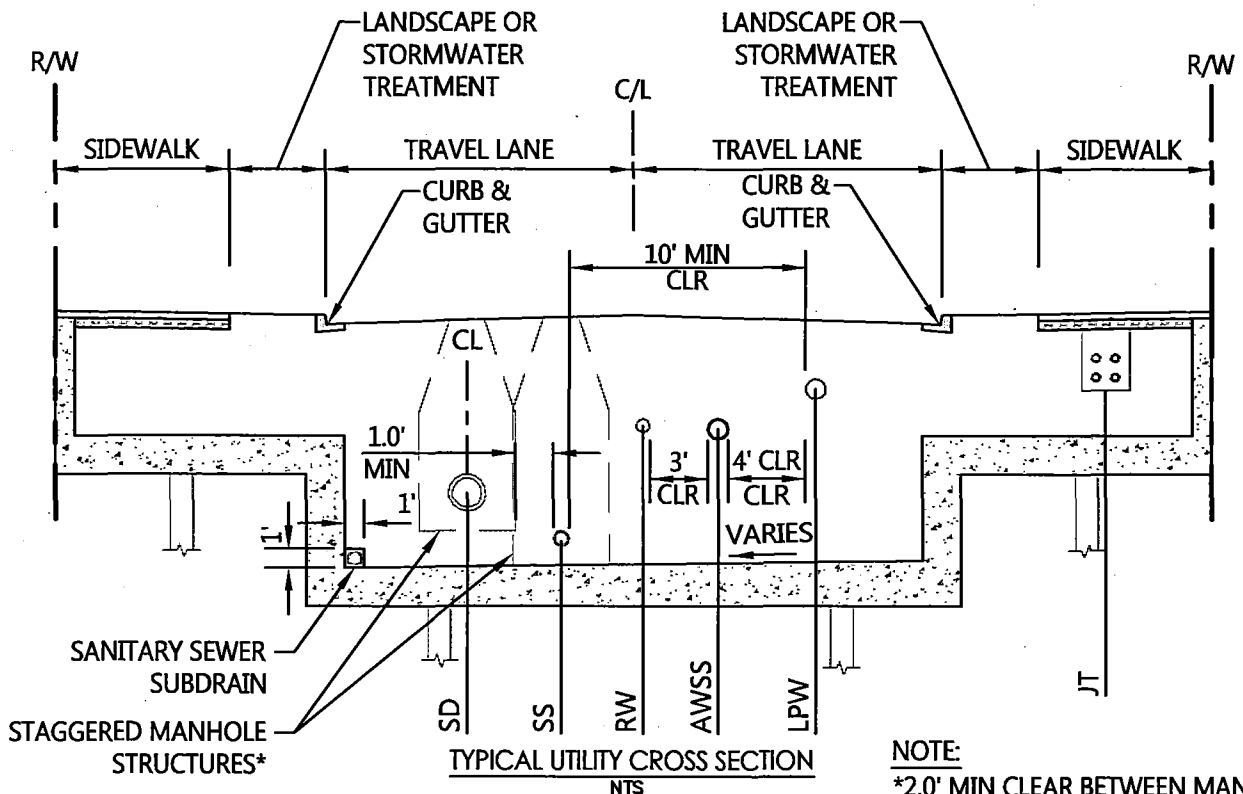

NOTE:
 *2.0' MIN CLEAR BETWEEN MANHOLE STRUCTURES, 1.0' MIN CLEAR FROM PIPE OD TO OUTSIDE MANHOLE STRUCTURE

Source: ENR ENGINEERS, 07/2018

15. DISTRICT UTILITY INFRASTRUCTURE

15.1 Central Utility Plant

The Mission Rock development will utilize a central utility plant (CUP) in Block A for heating and cooling, greywater collection treatment, and non-potable water distribution infrastructure required to achieve the sustainability goals of the Project. The heating and cooling may be provided by a bay sourced cooling loop that will connect the Bay to the chillers at the CUP, or through an approved, alternative heat exchange method. Greywater, which refers to wastewater collected from building systems without fecal contamination, will be collected and directed to the CUP for treatment before distribution throughout the Project for non-potable uses. The development is considered a Type-I Eco-District. The infrastructure maximizes efficiencies by providing budget certainty for thermal services. In addition to providing a sustainable district energy system throughout the site, the Type-I Eco-District development will also meet the San Francisco Eco-District guidelines. For additional information, refer to the District Heating and Cooling Services at Mission Rock prepared by Arup, dated May 13, 2016 in Appendix M and the latest edition of the Sustainability Strategy prepared by Atelier Ten.

15.1.1 Central Utility Plant Components

The CUP comprises a central district energy distribution plant, bay source cooling, and a greywater treatment and distribution plant at Block A. The central energy plant will provide chilled and hot water to each Development Parcel to support mechanical system demands. The greywater treatment plant will supply non-potable water to each Development Parcel. The distribution system will be developed with consideration to other site utilities, but is anticipated to be predominately routed through Shared Public Way, Bridgeview Street, and China Basin Park. Considerations for this utility routing include limiting the amount of district utilities that are parallel to the main public utilities in Exposition Street and Long Bridge Street and development phasing. Locations for each Development Parcel's heating hot water and chilled water connections, greywater collection point of connection, and non-potable water distribution point of connection will be determined during the vertical design for each Development Parcel.

15.1.2 Central Energy Plant

The Project has a goal to use renewable energy for 100% of its building energy demands, thereby offsetting its projected greenhouse emissions. The central energy plant will be powered by 100% renewable energy. The renewable energy may be purchased from an off-site renewable power

provider and delivered to the site via the power provider. Chilled water and hot water supply and return lines will distribute heating and cooling energy from the central energy plant at Block A to each Development Parcel. Each Development Parcel will be required to connect to this system, which also significantly reduces the volume of water required by cooling towers. Chilled water and heating hot water supply lines are distributed to the Development Parcels from the central energy plant at Block A through Shared Public Way, Bridgeview Street, and China Basin Park.

15.1.3 Heat Rejection and Cooling

Bay water may be used for heat rejection and cooling in the district energy system to minimize the energy demand for cooling and provide significant water savings by reducing the need for cooling towers. Cooling will be provided by the bay source cooling loop that rejects heat from the chillers at the central plant to the Bay. This heat exchange requires very little energy. The HDPE Intake and outfall pipes will be placed within the Pier 48 footprint, at or slightly below the seabed elevation and on top of plastic lumber. The inlet screens will be in deep water, protected by the pier and accessible for maintenance. Secondary screening may also be provided at the pump station on-shore or near the bulkhead. The bay source heat rejection infrastructure will likely consist of two 24-inch pipes located in China Basin Park that provide a connection between the intake/outfall at Pier 48 and the central plant at Block A, shown on Figure 15.1. Backup cooling towers may be required for emergency or maintenance operations when the bay source cooling system is offline.

15.1.4 Greywater Collection and Treatment Infrastructure

The Project has established a goal to use non-potable water for 100% of the non-potable water demand. Non-potable water demands include irrigation, toilet flushing and cooling towers. However, the demand for cooling towers is minimized by the bay source cooling and heat rejection system; thus, the non-potable demands for the purposes of this section include only irrigation and toilet flushing. Greywater will only be collected from the largest greywater-producing buildings, which includes Blocks A and K in Phase 1 and Block F in Phase 3. Greywater is conveyed to the greywater treatment plant in Block A, as shown on Figure 15.2. Non-potable water (treated greywater) is then distributed to the Development Parcels from the central greywater treatment plant at Block A through Shared Public Way, Bridgeview Street, and China Basin Park, as shown on Figure 15.3. The centralized approach optimizes the collection, treatment,

and distribution systems by producing enough non-potable water to meet 100% of the site's flushing and irrigation demands, while minimizing the amount of Infrastructure. A backup connection to the City's non-potable water main at 3rd Street will be required for emergency or maintenance operations when the greywater collection and non-potable water distribution system is offline. A connection to the SFPUC LPW potable main or the existing SFPUC recycled water main, which is currently fed by the LPW potable system in 3rd Street, may be required for the greywater treatment plant to supply backup water should the greywater treatment facility become temporarily non-operational.

Greywater and non-potable water system designs will comply with Article 12C of the San Francisco Health Code. Required SFPUC water budget application materials will be submitted to the City as part of the phase applications and construction document submittals.





15.2 Phases for District Utility Infrastructure Construction

The Developer will design and install the new central utility district infrastructure based on the principle of adjacency and as-needed to facilitate a specific proposed Development Phase and consistent with the requirements of the DA, DDA and ICA. The amount and location of the proposed central utility district infrastructure installed will be the minimum necessary to support the Development Phase.

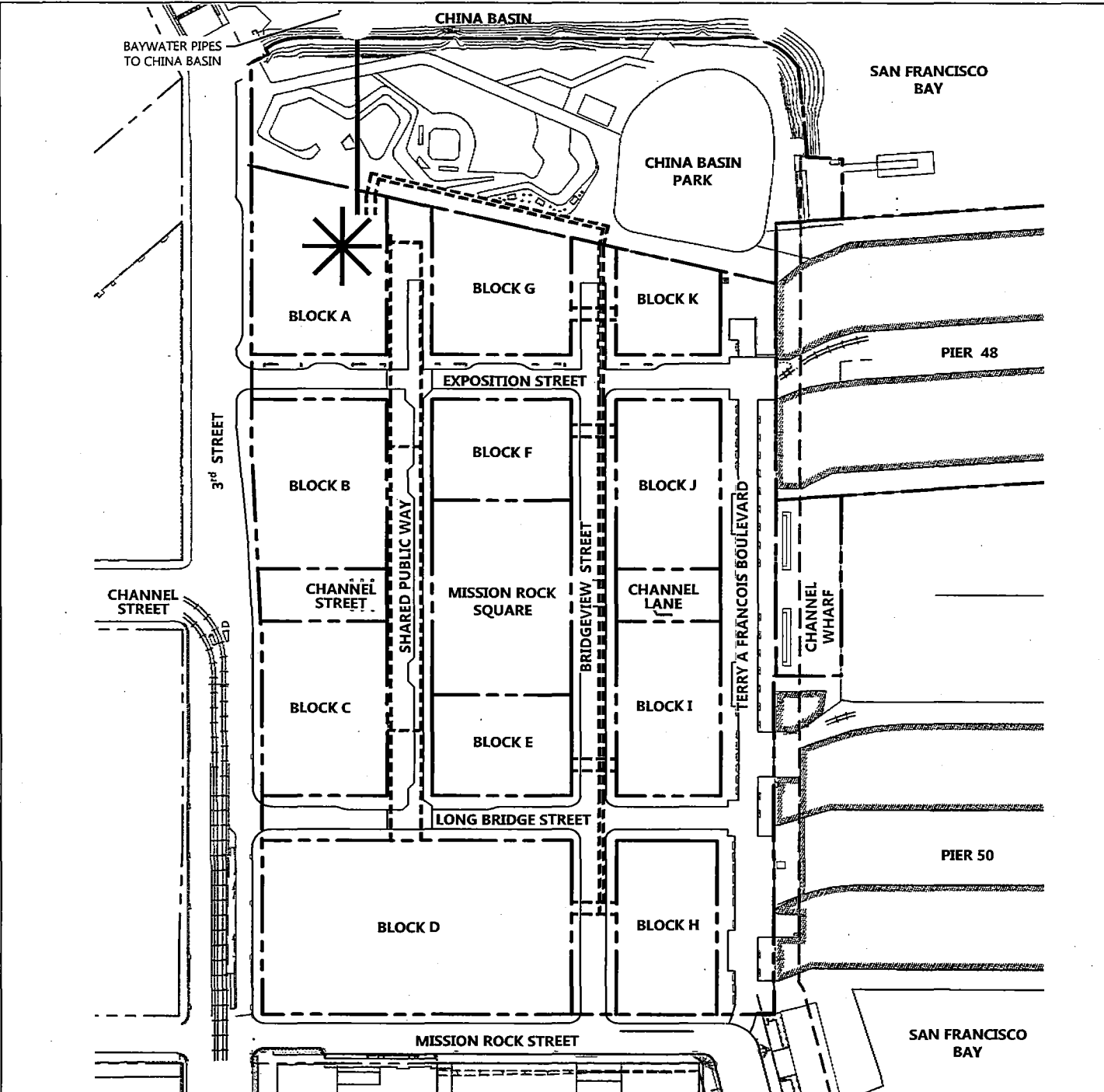
The Private Entity, other Agent, or the Acquiring Agency will be responsible for ownership and maintenance of new district utility infrastructure with permitting coordinated by The Private Entity, other Agent, or Developer. Ownership, maintenance, and acceptance responsibilities for district utility infrastructure will be documented in a separate agreement. Impacts to central utility district infrastructure installed with previous Development Phases of the Project due to the designs of new Development Phases will be the responsibility of the Developer and addressed prior to approval of the construction drawings for the new Development Phase.

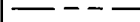
DRAWING NAME: \\p1-se\vol14\2008\080006\Mission Rock\ENG\Exhibits\Infrastructure Plan Exhibit\Plotted Sheets\Figure 15.1 Conceptual Utility District Infrastructure.dwg
 PLOT DATE: 07-15-17
 PLOTTED BY: FEL



- LEGEND**
-  PROPOSED PARCEL LINE
 -  EXISTING PARCEL LINE
 -  DISTRICT ENERGY (12" CHW & 8" HHW)
 -  BAYWATER COOLING (24" HDPE)
 -  CENTRAL PLANT
DISTRICT ENERGY DISTRIBUTION

Source: BKF ENGINEERS, 07/2016

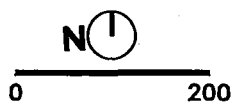

MISSION ROCK INFRASTRUCTURE PLAN 0871 FIGURE 15.1 - CONCEPTUAL UTILITY DISTRICT INFRASTRUCTURE

DRAWING NAME: \\BKF-SF\vol\4\2008\080006_Mission_Rock\ENG\Exhibits\Infrastructure_Plan_Exhibits\Plotted_Sheets\Figure_15.2_Conceptual_Greywater_Infrastructure.dwg
 PLOT DATE: 07-13-17
 PLOTTED BY: FEL

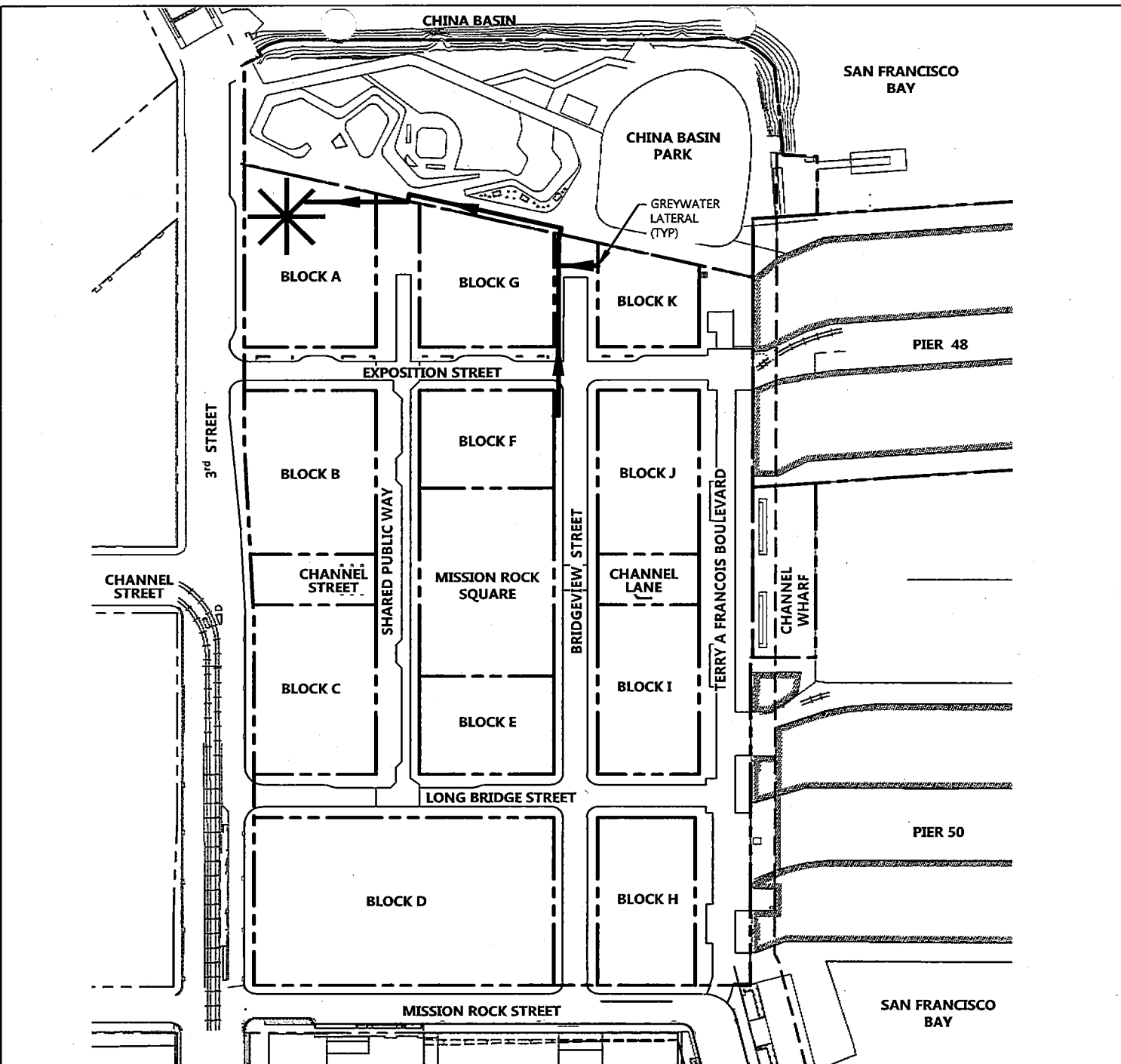

LEGEND

- PROPOSED PARCEL LINE
- - - EXISTING PARCEL LINE
- PROPOSED GREYWATER LINE (8" DIP)
- GREYWATER COLLECTION & TREATMENT PLANT

Source: BKF ENGINEERS, 07/2016

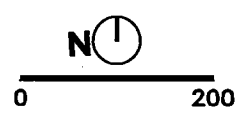

MISSION ROCK INFRASTRUCTURE PLAN 0872 FIGURE 15.2 - CONCEPTUAL GREYWATER INFRASTRUCTURE

DRAWING NAME: \\pk1-sf\vo14\2008\00000000\Mission Rock\Eng\Exhibits\Infrastructure Plan Exhibits\Plotted Sheets\Figure 15.3 Conceptual Recycled Water Infrastructure.dwg
 PLOT DATE: 07-13-17
 PLOTTED BY: FEL

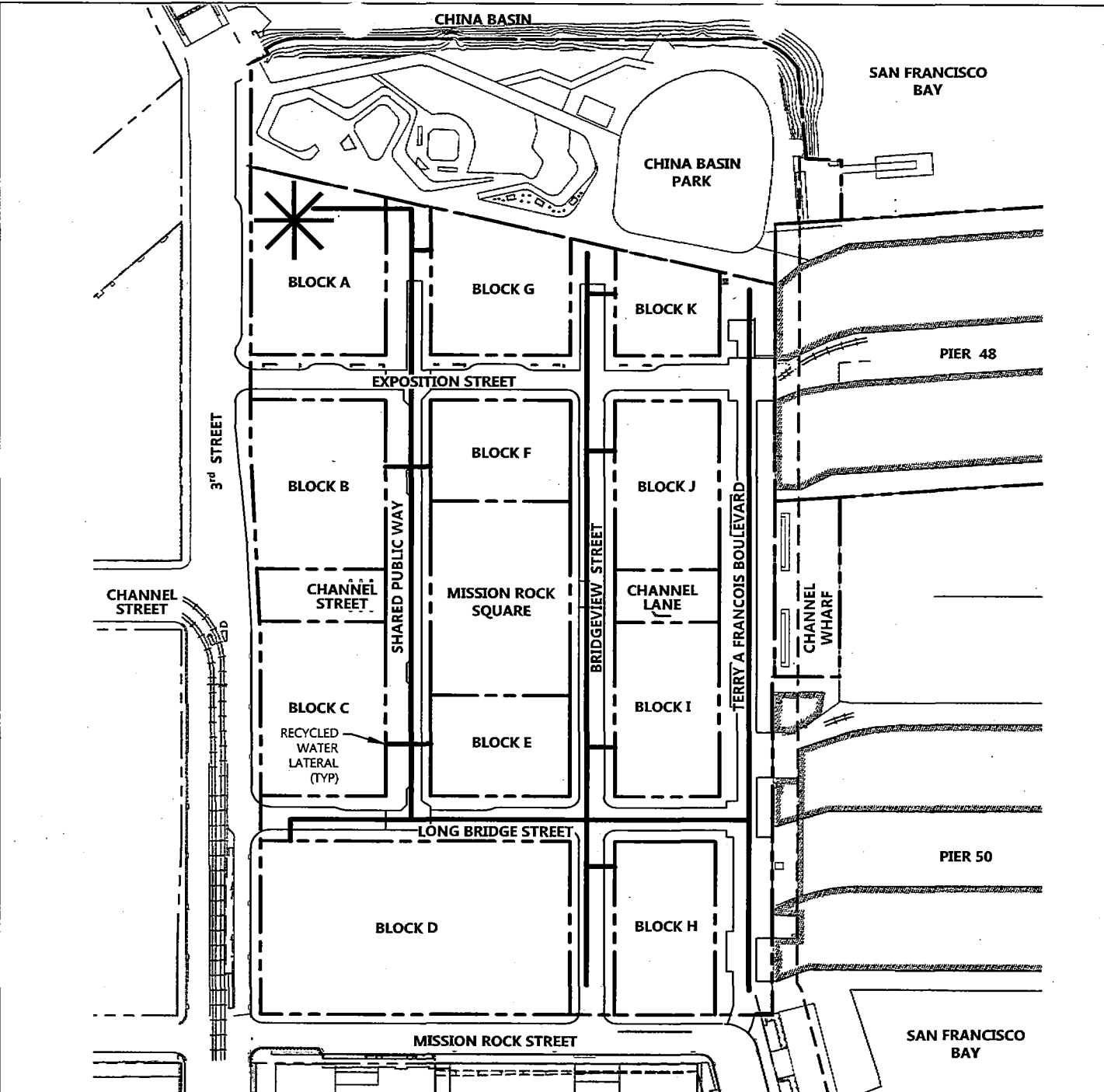

- LEGEND**
- PROPOSED PARCEL LINE
 - - - EXISTING PARCEL LINE
 - PROPOSED NON-POTABLE WATER DISTRIBUTION LINE (8" DIP)
 - ★ GREYWATER COLLECTION & TREATMENT PLANT

Source: BKF ENGINEERS, 07/2018

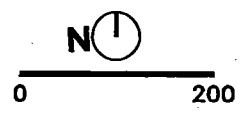

16. STORMWATER MANAGEMENT SYSTEM

16.1 Existing Stormwater Management System

The existing site is approximately 96.6 percent impervious, mostly covered in pavement with a park to the north. The existing site drains to storm drain systems that discharged directly or indirectly to the San Francisco Bay. The west side of the Project is served by an existing SFPUC storm drain system within 3rd Street that is routed to the future SWPS #3 for discharge to Mission Creek. Until SWPS #3 is constructed portions of the run-off discharge to an existing 11' x 11' combined sewer. The re-aligned Mission Rock Street has a new storm drain system that conveys stormwater to Mission Bay SWPS #6 to the south that discharges to the San Francisco Bay adjacent to Radiance and Block P18. Both China Basin Park and Terry A Francois Boulevard have storm drain systems that discharge directly to the San Francisco Bay through existing Port outfalls. The existing condition of the Project site does not include any stormwater facilities to treat stormwater flows prior to discharge.

16.2 Proposed Stormwater Management System

16.2.1 San Francisco Stormwater Management Requirements & Design Guidelines

The SMR is the regulatory guidance document describing requirements for post-construction stormwater management. Stormwater management performance requirements are determined based on the storm drain system available to connect into as well as the jurisdiction of the storm drain system. For Project areas that will connect into the SFPUC's existing separated storm drain system in 3rd Street or Mission Rock Street, or a SFPUC accepted outfall, the SMR requires the Project to implement a stormwater management plan that results in capture and treatment of all stormwater runoff from the 90th-percentile storm event prior to discharge to the separated storm sewer system. For Project areas that will be served by the Port's separated storm drain system outfalling directly to the San Francisco Bay through a Port outfall, the SMR requires the Project to implement a stormwater management plan that results in capture and treatment of all stormwater runoff from the 85th percentile storm event.

16.2.2 Proposed Site Conditions and Baseline Assumptions

The Project includes public streets, parks and plaza open space areas, and Private Development Parcels. The Project will be designed to integrate Low Impact Development (LID) elements with stormwater best management practices (BMPs) to create a sustainable environment at the site and achieve compliance with the SMR. LID elements include landscaping, permeable paving

materials, and vegetated roofs to reduce stormwater runoff from hardscape surfaces. Stormwater treatment BMPs considered for the Project include street flow-through planters, bioretention areas, rain gardens, and green roofs to treat stormwater runoff prior to discharging to the public separated storm drain system.

Public streets will consist of at-grade streets or pile-supported structured streets with a combination of landscape strips, tree wells, permeable pavers, and street flow-through planters. China Basin Park will be elevated by a combination of planting soil and Geofoam within the park and structured streets within the Promenade. Mission Rock Square may be a pile-supported podium or constructed on lightweight fill, Geofoam, and/or imported fill material. China Basin Park and Mission Rock Square will include landscape strips, tree wells, and centralized bioretention areas. The development parcels will be covered entirely with podium structures consisting of a combination of landscape planters, tree wells, green roofs, and pedestrian pathways.

16.2.3 Stormwater Management Design Concepts and Master Plan

The SMR requires the Project to implement BMPs to capture and treat stormwater runoff from all impervious areas for the design storm event. To be included with the Stormwater Management Master Utility Plan, a process flow diagram illustrating the limits of the drainage management areas (DMAs), location of stormwater discharge to existing storm drain system, and jurisdiction of existing storm drain system will be developed to illustrate compliance with the SMR.

The conceptual stormwater management plan for the Project includes DMAs with either localized treatment or centralized treatment facilities. Localized treatment occurs in DMAs that are able to direct surface runoff to BMPs that are sized to treat stormwater runoff from impervious areas per the given design storm event. Private development parcels located within DMAs with localized treatment will allocate a space to implement BMP measures and treat stormwater for the design storm event prior to discharging into the adjacent public storm drain system. Alternatively, Development Parcels also have the option to collect and reuse stormwater on-site.

For areas that are not able to treat surface runoff prior to entering the storm drain system, untreated runoff is pumped to centralized treatment facility located in either China Basin Park or Mission Rock Square. Private development parcels within DMAs without localized treatment are

not required to implement additional BMP measures on-site where centralized treatment areas are sized to treat runoff from the private development parcels.

The conceptual stormwater management approach for the Project is presented in Figure 16.1. Stormwater management performance quantities and strategies will be documented as part of the Project Stormwater Management Master Utility Plan to be submitted for review and approval by the SFPUC and Port.

16.3 Stormwater Control Plan

Based on the designs to be reviewed and approved by the SFPUC and Port as part of the Stormwater Management Master Utility Plan, the stormwater management strategies for the Project will be documented in a Stormwater Control Plan (SCP) in compliance with SFPUC and Port stormwater management regulations and the requirements of the SMR. The selected modeling methodology will be per the SFPUC and Port-accepted hydrologic calculation methods. The Preliminary SCP for the public improvements will be submitted for review and approval before the 60% Improvement Plan for each phase of the project, and the Final SCP will be submitted with the 95% Improvement Plan for that phase or Development Parcel and prior to construction. For Development Parcels, a Preliminary SCP and Final SCP shall be submitted for approval per SFPUC and Port stormwater management requirements.

16.4 Phases for Stormwater Management System Construction

The Developer will design and install the new stormwater management system based on the principle of adjacency and as-needed to facilitate a specific proposed Development Phase and consistent with the requirements of the DA, DDA and ICA. The amount and location of the proposed stormwater management systems installed will be the minimum necessary to support the Development Phase. The new Development Phase will connect to the existing systems as close to the edge of the Development Phase area as possible while maintaining the integrity of the existing system for the remainder of the Project. Development phasing with regard to stormwater treatment and storm drain system is conceptual and remains under design. The phasing and simplification of the stormwater treatment and drain systems will be further coordinated with the SFPUC prior to approval of the MUPs.

At all phases of the development, the Developer must provide functioning and adequate stormwater management in compliance with the SFPUC and Port's post-construction stormwater management requirements and the SMR. The Developer will be required to complete the review process with SFPUC

and Port to seek approval for the Preliminary SCP and Final SCP for each Development Phase. The street right-of-way and Park Improvement Plans must have Final SCP approval prior to issuance of the Street Improvement Permit (SIP). In addition, the Developer must complete the construction of the approved stormwater management and treatment improvements required for each development phase prior to receiving a Certification of Completion for the development phase.

Permanent or interim centralized stormwater management and treatment facilities necessary to achieve SMR compliance within a development phase will be constructed and operational prior to or in conjunction with that phase. Interim stormwater BMPs implemented as part of the on-site remediation will be preserved on undeveloped parcels. As required by the SFPUC and Regional Water Quality Control Board (RWQCB), the Developer will be responsible for constructing and maintaining interim stormwater management and treatment infrastructure, and ensuring such interim treatment facilities remain online and operating continuously until permanent BMP infrastructure is fully functional and operating.

Stormwater management and treatment systems, which may include bioretention areas, street flow-through planters, pump stations, and storage areas located on public or private property within the Project, will be constructed and maintained by the Acquiring Agency, Developer, or its Assignees, where applicable, per the terms of the DA and DDA, ICA, or separate MOU/MOA between the Port, City, and Developer.

DRAWING NAME: \\BKF-SF\vol14\2008\080000_Mission Rock\EMO\Exhibits\Infrastructure Plan Exhibits\Plotted Sheets\Figure 16.1 Conceptual Stormwater Management Plan.dwg
 PLOTTED BY: FELI
 PLOT DATE: 07-15-17
 SOURCE: BKF ENGINEERS, 07/2016

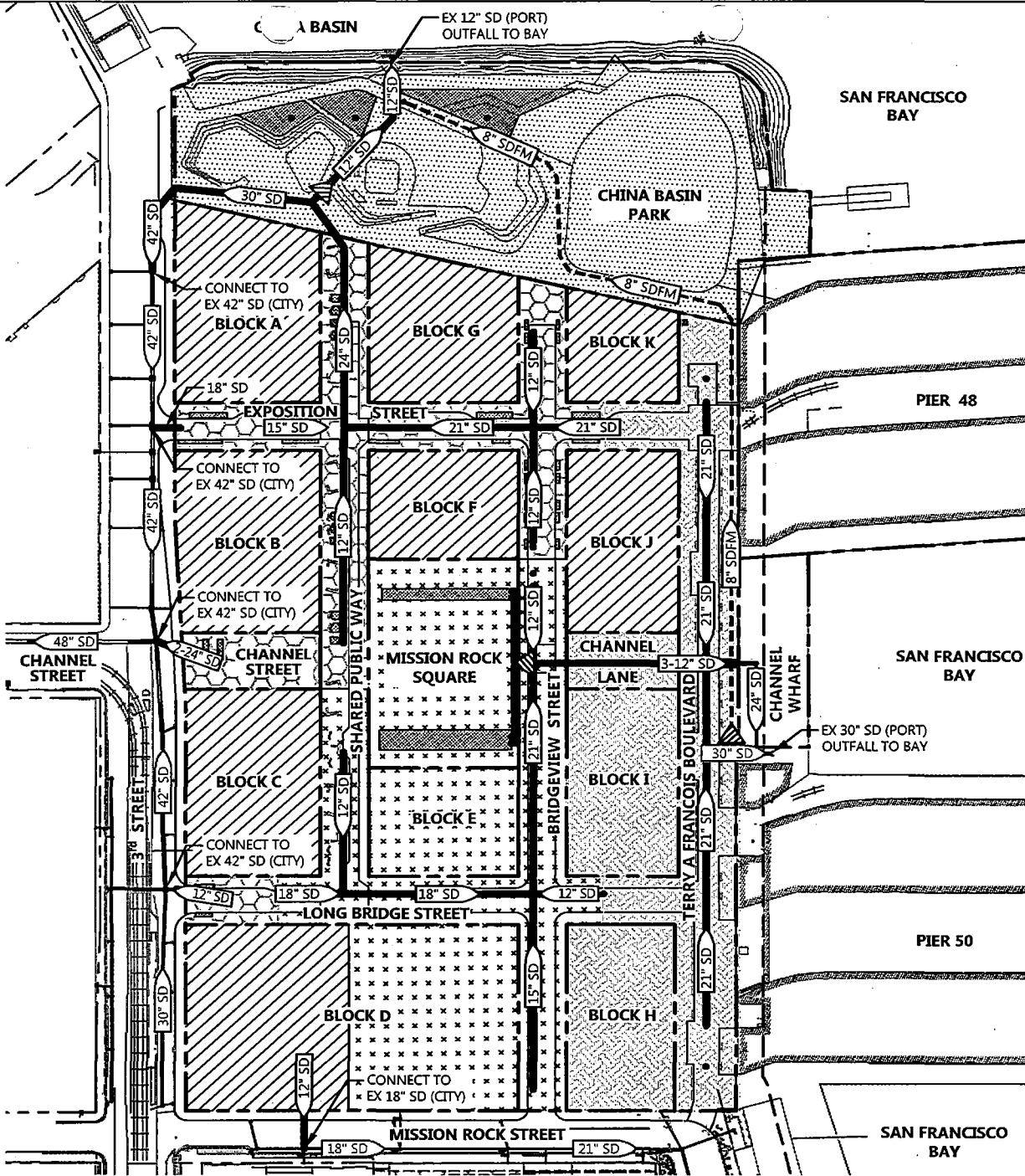

LEGEND

- PROPOSED PARCEL LINE
- EXISTING PARCEL LINE
- 30" SD EXISTING STORM DRAIN LINE
- 12" SD PROPOSED STORM DRAIN MAIN
- 8" SDFM PROPOSED STORM DRAIN FORCE MAIN
- PROPOSED STORM DRAIN MANHOLE
- LOCALIZED STORMWATER TREATMENT AT DEVELOPMENT
- LOCALIZED STORMWATER TREATMENT AT STREETS
- PUMPED TO MISSION ROCK SQUARE FOR CENTRALIZED STORMWATER TREATMENT
- PUMPED TO CHINA BASIN PARK FOR CENTRALIZED STORMWATER TREATMENT
- DRAINED TO CHINA BASIN PARK FOR CENTRALIZED STORMWATER TREATMENT
- BIORETENTION AREA
- TREATMENT PUMP STATION

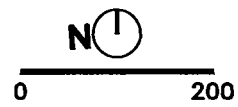

17. DRY UTILITY SYSTEMS

17.1 Existing Electrical, Gas, and Communication Systems

The existing parking lot is bordered by overhead PG&E electrical lines on Terry A Francois Blvd, 3rd Street and Mission Rock Street. The SFPUC provides electrical service to existing facilities at Piers 48 and 50 using existing rights to the overhead PG&E lines serving Piers 48 and 50 and is responsible for invoicing the existing facilities. Existing street lighting and telecom infrastructure are also located along 3rd Street and Mission Rock Street. Site lighting is also located within the Project. 3rd Street serves as a municipal transportation route and contains multiple Overhead Contact System (OCS) lines, owned by SFMTA, which will be maintained during and after construction. Existing PG&E gas and AT&T, or other fiber providers, telecom lines, serving Piers 48 and 50 are located on Terry A Francois Blvd as well.

17.2 Project Power Providers and Requirements

Pursuant to Chapter 99.3 of the San Francisco Administrative Code, all leases and subleases on City property shall receive electric service from the SFPUC unless the SFPUC determines that such service is not feasible. In September 2016, the SFPUC notified the Port and the Developer of its intention to continue to be the electricity provider for the Project and the other Port properties in the vicinity, including Piers 48 and 50. The SFPUC shall prepare an assessment of the feasibility of the City providing electric service to the development (the "Feasibility Study"). The Developer will cooperate with SFPUC in SFPUC's preparation of the Feasibility Study. The Feasibility Study shall include, but not be limited to, the following: 1) electric load projection and schedule; 2) evaluation of existing electric infrastructure and new infrastructure that will be needed; 3) analysis of purchase and delivery costs for electric commodity as well as transmission and distribution services that will be needed to deliver power to the development; 4) the potential for load reduction through energy efficiency and demand response; 5) business structure cost analysis; and 6) financial and cost recovery period analysis. Should the City elect to provide electric service to the Project, such service shall be provided by the City on terms and conditions generally comparable to the electric service otherwise available to the Project. If the City determines that providing power services to the Project is infeasible, the developer will pursue PG&E or other power providers to serve the Project. Should the Project be served by SFPUC power, the Developer will enter into an Electric Service Agreement with the SFPUC.

17.3 Proposed Joint Trench

The proposed Joint Trench is identified schematically on Figures 17.1 and 17.2. Services and lighting will also be provided as required to China Basin Park and Mission Rock Square. Work necessary to provide the joint trench for dry utilities, typically installed within public streets and adjacent sidewalk area, consists of trench excavation and installation of conduit ducts for electrical, gas, and communication lines. In locations where public streets will be built upon structural piles, the joint trench utilities will be installed within the structured street section. Utility vaults, splice boxes, street lights and bases, wire and transformer allowance, and backfill will be included within the structured street section. Gas, Electric and power systems will be constructed per the applicable standards of the agency or company with controlling ownership of said facilities with street lighting infrastructure constructed per City standards. The utility owner/franchisee (such as SFPUC, PG&E, AT&T, Comcast and/or other communication companies) will be responsible for installing facilities such as transformers and wire. Necessary and properly authorized public utility improvements for which franchises are authorized by the City shall be designed and installed in the public right-of-way in accordance with permits approved by SFPDW and SFPUC. Proposed dry utility infrastructure location and separation from parallel wet utilities shall comply with the utility owner's regulations. Joint trenches or utility corridors will be utilized wherever allowed. The location and design of joint trenches or utility corridors in the public right-of-way must be approved by SFPDW and the SFPUC during the subdivision review process. The precise location of the joint trench in the right-of-way will be determined prior to recording the applicable Final Map and identified in the Project construction documents. Nothing in this Infrastructure Plan shall be deemed to preclude the Developer from seeking reimbursement for or causing others to obtain consent for the utilization of such joint trench facilities where such reimbursement or consent requirement is otherwise permitted by law.

17.4 Phases for Dry Utility Systems Construction

Joint trench design and installation will occur in phases based on the principle of adjacency and as-needed to facilitate a specific proposed Development Phase and consistent with the requirements of the DA, DDA and ICA. The amount of existing system replaced and new infrastructure installed along Terry A Francois Blvd, 3rd Street and Mission Rock Street will be the minimum necessary to support the Development Phase and piers. The new infrastructure will connect to the existing systems as close to the proposed development as possible while maintaining the integrity of the existing system. Repairs and/or replacement of the existing facilities necessary to serve the Development Phase will be designed and

constructed by the Developer. Such phased dry utility installation will allow the existing utility services to remain in place as long as possible and reduce disruption of existing uses on the site and adjacent facilities. Temporary or interim electric or dry utility infrastructure may be constructed and maintained as necessary to support service to existing buildings.

The service providers will be responsible for maintenance of existing facilities until replaced by the Developer. In the interim, the service provider is responsible for any power facilities installed under any agreement with the Developer and Acquiring Agency. The service provider will also be responsible for any new power facilities once the horizontal improvements for the Development phase or the new power facility is complete and accepted by the Acquiring Agency.

Impacts to improvements installed with previous Development Phases due to the designs of the new Development Phase will be the responsibility of the Developer and addressed prior to approval of the construction drawings for the new Development Phase.

DRAWING NAME: \\BKF-SF\va\4\2008\00000000\Mission_Rock\EMO\Exhibits\Infrastructure_Plan_Exhibits\Plotted_Sheets\Figure 17.1 Conceptual Dry Utility Systems.dwg
 PLOT DATE: 07-15-17
 PLOTTED BY: FELI

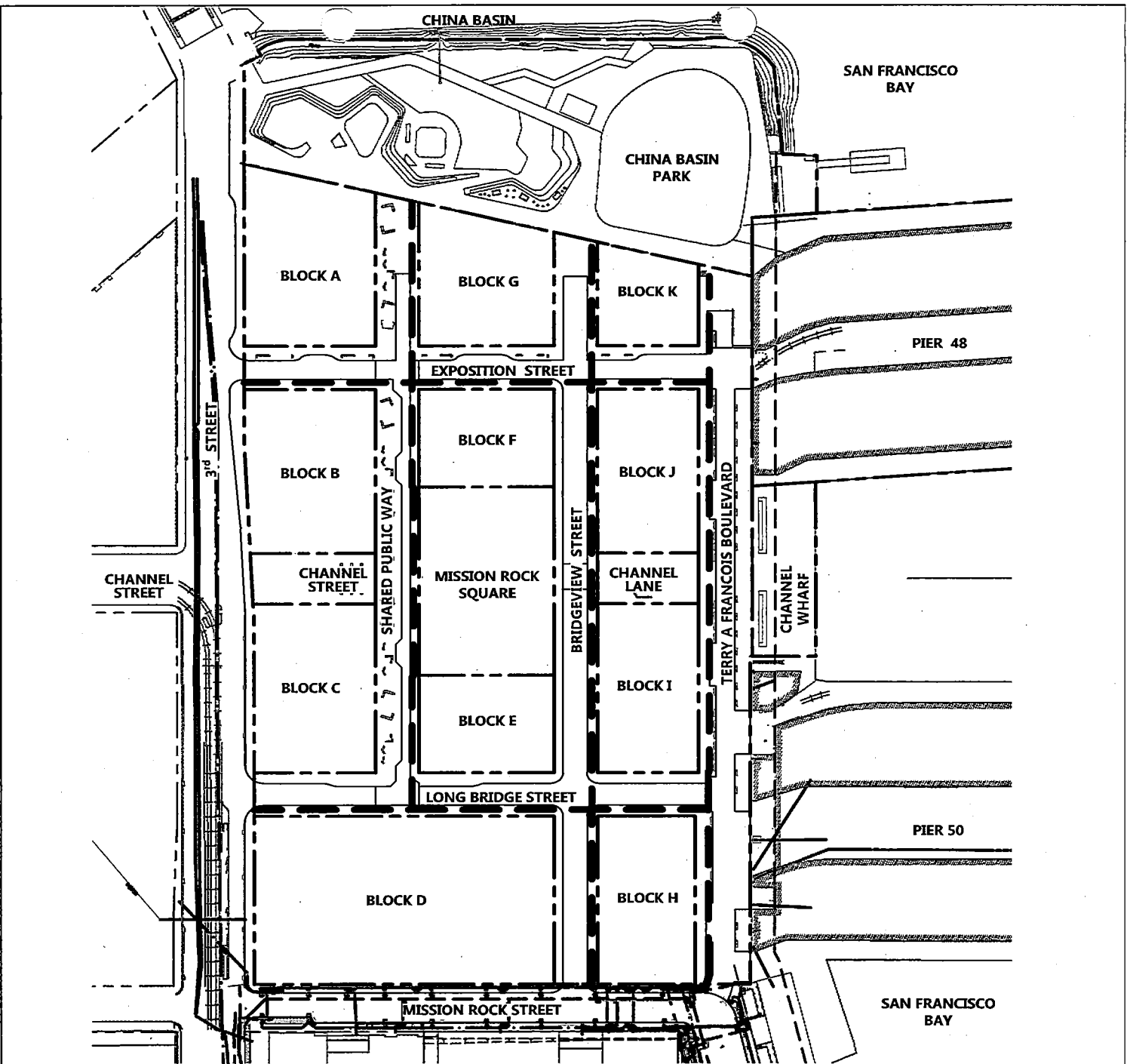

- LEGEND**
- PROPOSED PARCEL LINE
 - - - EXISTING PARCEL LINE
 - PROPOSED JOINT TRENCH
 - - - EXISTING ELECTRIC LINE
 - - - EXISTING JT LINE
 - EXISTING STREET LIGHT
 - EXISTING JT STRUCTURE
 - EXISTING ELECTRIC STRUCTURE

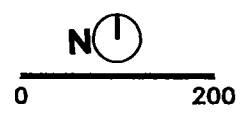

Source: BKF ENGINEERS, 07/2016

DRAWING NAME: \\vik1-sf\vol14\2008\080000_Mission Rock\ENG\Exhibits\Infrastructure Plan Exhibit\Plotted Sheets\Figure 11.2_14.2 Typical Utility Section.dwg
 PLOT DATE: 11-13-17
 PLOTTED BY: vsk

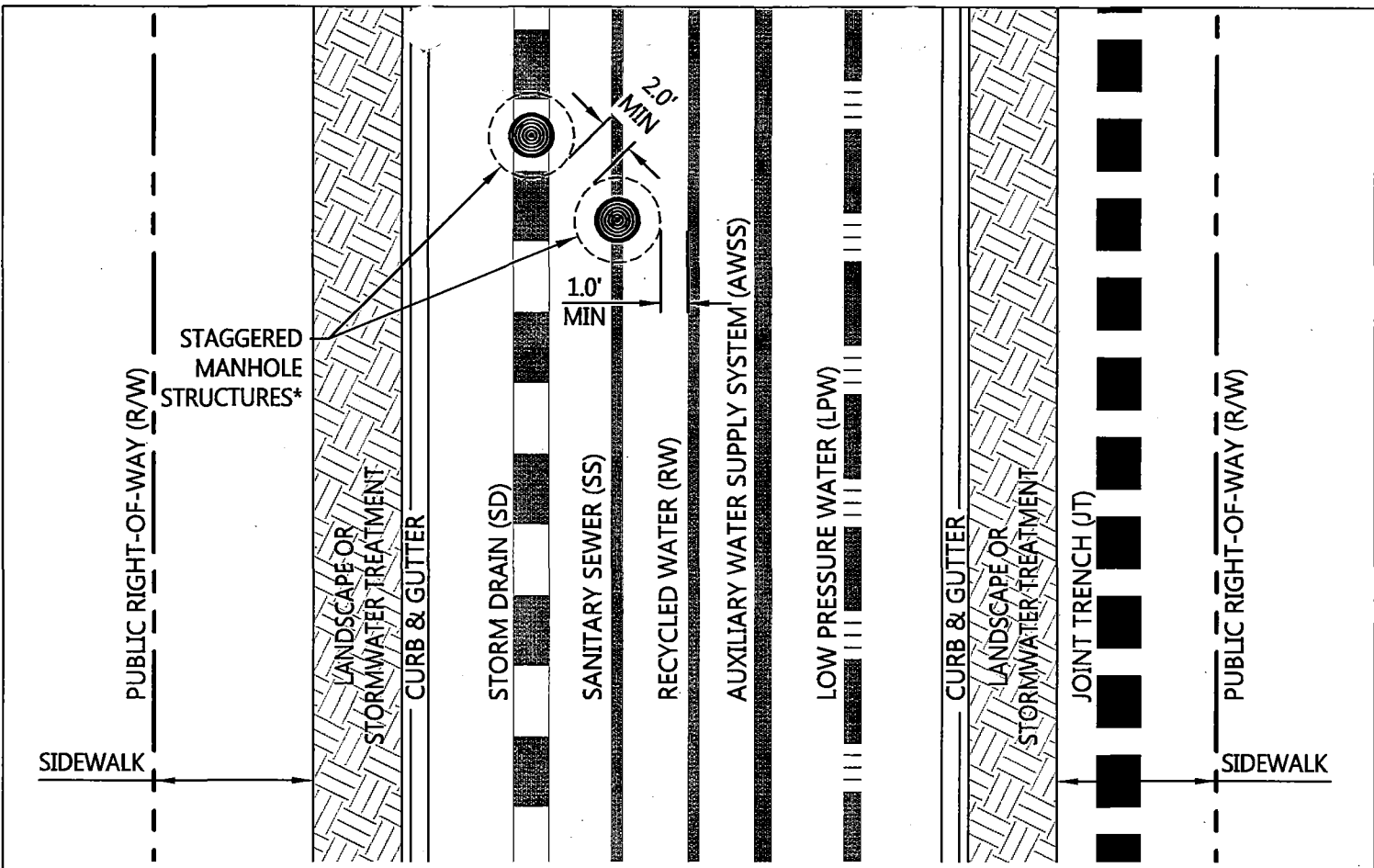

TYPICAL STREETS
NTS

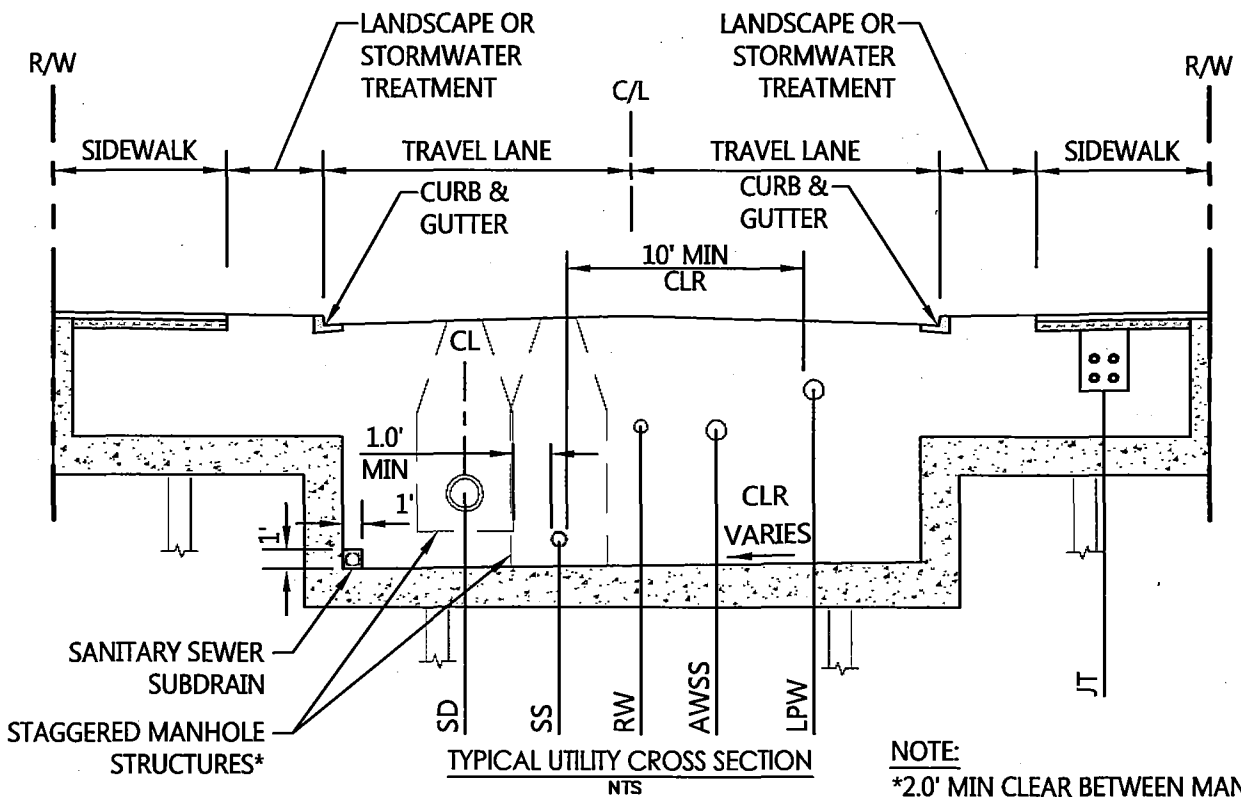

TYPICAL UTILITY CROSS SECTION
NTS

NOTE:
 *2.0' MIN CLEAR BETWEEN MANHOLE STRUCTURES, 1.0' MIN CLEAR FROM PIPE OD TO OUTSIDE MANHOLE STRUCTURE

Source: BRG ENGINEERS, 07/2016

**APPENDIX A
(Not Used)**

APPENDIX B
Hazardous Soil Remediation Plan Letter
September 12, 2011



Ash Creek Associates, Inc.

Environmental and Geotechnical Consultants

September 12, 2011

Jon Knorpp
Seawall Lot 337 Assoc., LLC
24 Willie Mays Plaza
San Francisco, CA 94107

Re: Mission Rock Development – Seawall Lot 337
San Francisco, California
1868-00

Dear Mr. Knorpp:

As requested, this letter outlines the anticipated steps to complete the environmental program related to potential hazardous substances in soil and groundwater at the subject site. Mission Rock Development is planning a mixed use development at Lot 337 in San Francisco, California (the Site). Figure 1 provides a Site Location Map. The Site is a former industrial property within the area subject to the requirements of Article 20 of the City and County of San Francisco Public Health Department Ordinance 253-86 (the Maher Ordinance). In addition, Covenant to Restrict Use of Property (Use Restrictions) were recorded in agreements between the City and County of San Francisco (City) and the California Department of Toxic Substance Control (DTSC) as a part of previous development of the Site. As described herein, these documents outline certain requirements that will need to be met prior to initiating the proposed site development.

BACKGROUND

Environmental investigations were performed at the Site in the 1990s when the Site was redeveloped for use as a parking lot and park. The scope of the investigations performed was developed to satisfy the requirements of the Maher Ordinance and to achieve site closure from the City and DTSC. Several documents were prepared documenting the scope and results of these investigations, including:

- Site Use History and Proposed Article 20 Sampling Program, Proposed Imperial Weitz Parking Lots South of China Basin Channel, San Francisco California prepared by Geomatrix Consultants, Inc. dated March 1999;
- Results of Article 20 Sampling Program and Health Risk Assessment, Proposed Imperial Weitz Parking Lots for the Giants Pacific Bell Ball Park Area e – Port of San Francisco, San Francisco California prepared by Geomatrix Consultants, Inc. dated June 1999;
- Preliminary Screening Evaluation, H&H Ship Service Company, San Francisco, California, prepared by Harding Lawson Associates dated September 14, 1995; and

3015 SW First Avenue
Portland, Oregon 97201-4707
(503) 924-4704 Portland
(360) 567-3977 Vancouver
(503) 943-6357 Fax
www.ashcreekassociates.com

- RCRA Closure Certification Report, Former H&H Ship Service Company, San Francisco, California, prepared by Harding Lawson Associates dated February 4, 1999.

Copies of these reports can be obtained at the Port of San Francisco website at the following link:
<http://www.sf-port.org/index.aspx?page=44>

As part of the cleanup requirements to achieve site closure, a Soil Management Plan was prepared to detail methods and procedures for soil handling, stockpiling, disposal, and accessing to be used during and after site development. A copy of the Soil Management Plan is included as Attachment A to this letter. In addition, land use restrictions were described in the Use Restrictions and recorded in two agreements between the City and DTSC (one for the part of the Site that is South of Terry Francois Blvd and currently used as a parking lot and the second that is north of Terry Francois Blvd and is currently used as a park). A copy of each of the Use Restrictions are included as Attachment B to this letter. The Use Restrictions require, amongst other items, that Maher Ordinance assessments be performed if more than 50 cubic yards of soil are to be disturbed and a variance be obtained if the Site is to be developed for any of the uses listed as "restricted" in the Use Restriction.

ANTICIPATED ACTIVITIES TO ACHIEVE ENVIRONMENTAL CLEARANCES

Based on a review of the available documents and the Use Restrictions for the Site, the following actions are anticipated to achieve environmental clearances of potentially hazardous substances in soil or groundwater necessary to complete the site development.

- 1) Use Variance. The current Use Restrictions do not allow residential development at the Site. It is our understanding that some of the Site may be developed for high-density housing as a part of the proposed development. The intent of the Use Restrictions is to preclude single family home development and it appears that high-density housing is an acceptable use of the Site. However, a variance to the Use Restrictions may be needed. A meeting with the DTSC and the Port of San Francisco (Port) will be conducted to discuss the proposed development and identify whether a variance will be needed from the provisions in the Use Restrictions. If a variance is required, the variance will be developed and written in conjunction with the DTSC and the Port.
- 2) Maier Ordinance. The Use Restrictions and City regulations require that the Maier Ordinance requirements be met prior to initiation of site development. Investigations satisfying the Maier Ordinance were performed in support of the previous development of the Site as a parking area and park. The investigations performed for the Maier Ordinance provided an understanding of both the soil and groundwater quality at the Site. A risk assessment was performed and did not identify unacceptable risk to construction workers or other receptors for that development. The scopes of the previous assessments are consistent with currently proposed site development and appear to be sufficient to meet the requirements of the Maier Ordinance. A meeting with the City and County of San Francisco Department of Public Health (DPH) will be conducted to discuss site conditions and the proposed development to illustrate how the previous investigations have collected the needed data to meet Maier Ordinance requirements for the new development.

If the DPH agrees that sufficient data has been collected to meet the Maier requirements for the Site, a report will be prepared that summarizes the proposed development and existing data for DPH review and approval to document that the Maier Ordinance requirements have been met. If the DPH does not agree and requests additional site data, a work plan will be prepared identifying the work scope and procedures to collect the data the DPH is requesting to meet the Maier Ordinance requirements. The work plan will be submitted to the DPH for review. Upon DPH approval of the work plan, the work scope will be completed and a results report prepared for submittal to DPH to achieve closure on the Maier Ordinance requirements. The DTSC will be kept apprised of the activities being performed to meet the Maier Ordinance to satisfy the requirements of the Use Restrictions.



REMEDIATION PLAN

Based on our understanding of the Site, it is anticipated that site remediation will consist of implementation of a Soil Management Plan consistent to that previously developed for the Site (see Attachment A). The Soil Management Plan describes the methods and procedures for soil management during site construction and following site development, and maintenance of a site cover. Soil management during site construction will consist of dust control, erosion control, stockpile management, and appropriate soil disposal should excess soil be excavated during construction activities. If excess soil is generated, the excess soil would need to be profiled to determine appropriate disposal options. Based on chemical analysis results of soil samples collected from the Site, total metal and organic concentrations are less than the Total Threshold Limit Concentrations (TTLCs) for designation as California Hazardous Waste. However, additional solubility testing of some of the metals (e.g., lead) would likely be required by disposal facilities to better assess the waste profile for the soil. It is possible that the solubility of the lead using the Waste Extraction Test would exceed the Solubility Threshold Limit Concentrations (STLCs) of the state. The excess soil would then be profiled as California Hazardous waste and would need to be disposed of at the appropriately licensed landfill facility.

Please do not hesitate to contact me should you have any questions.

Sincerely,

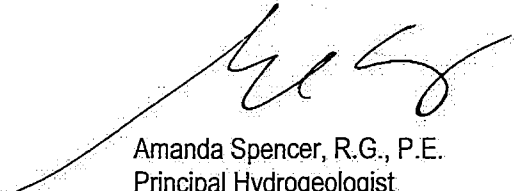

Amanda Spencer, R.G., P.E.
Principal Hydrogeologist

ATTACHMENTS

Figure 1 – Site Location Map

Attachment A – Soil Management Plan

Attachment B – Use Restriction



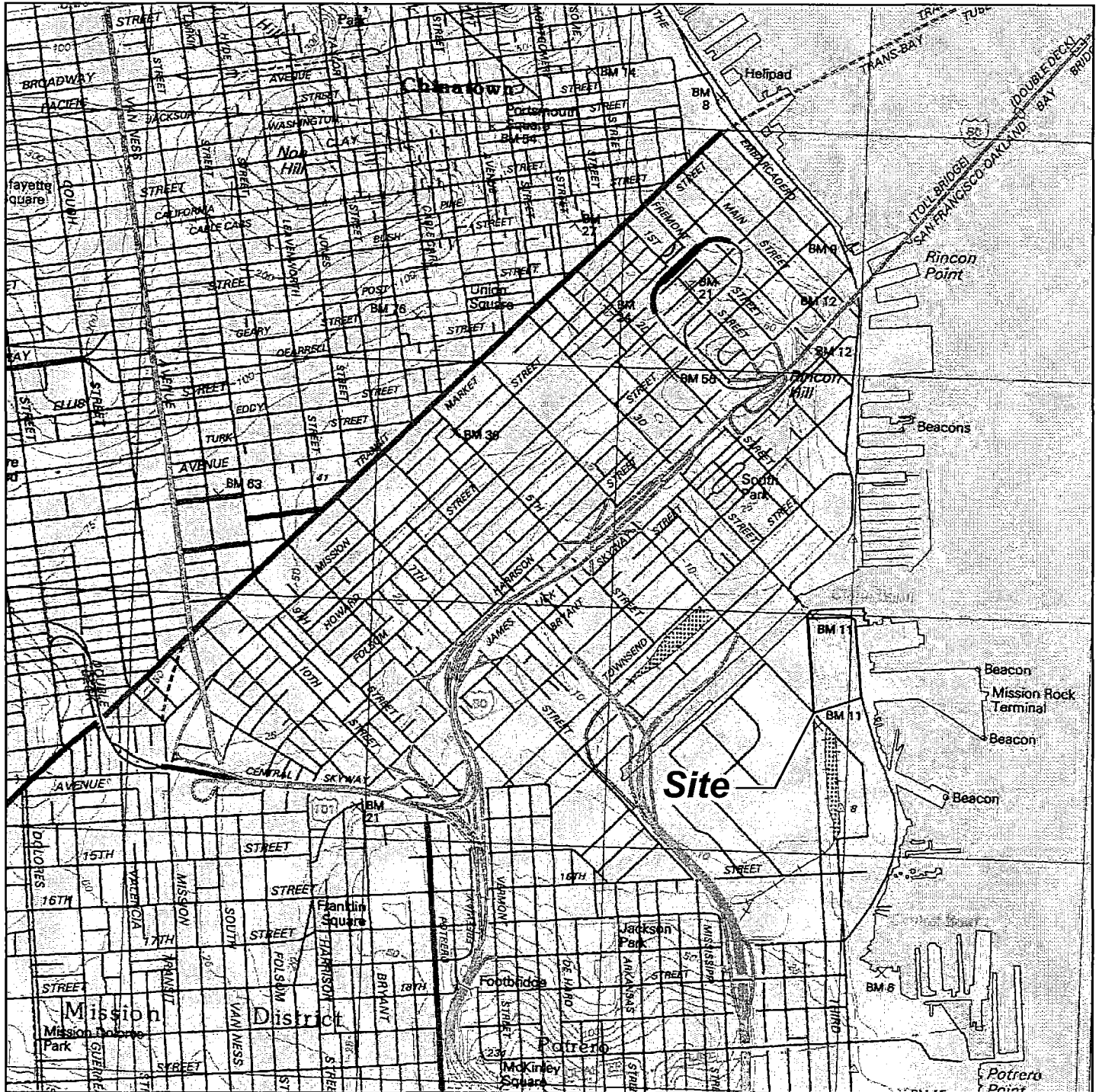

Note: Base map prepared from USGS 7.5-minute quadrangle of San Francisco North, CA, dated 1993 as provided by usgs.gov.



CALIFORNIA



0 2,000 4,000
Approximate Scale in Feet

Site Location Map

Mission Rock Development - Seawall Lot 337
San Francisco, California



Ash Creek Associates, Inc.
Environmental and Geotechnical Consultants

Project Number	1868-00
September 2011	

Figure
1

Attachment A

Soil Management Plan



SOIL MANAGEMENT PLAN

Imperial Weitz Parking Lots for the Giants Pacific Bell Ball Park Area E - Port of San Francisco Property

San Francisco, California

Prepared for:

Imperial Weitz, LLC
800 Second Avenue, Suite 300
Des Moines, Iowa 50309

Prepared by:

Geomatrix Consultants, Inc.
2101 Webster Street, 12th Floor
Oakland, California 94612
(510) 663-4100

June 1999

Project No. 4952

Geomatrix Consultants

TABLE OF CONTENTS

	Page
1.0 INTRODUCTION.....	1
2.0 BACKGROUND.....	1
2.1 SITE SETTING AND HISTORICAL USAGE.....	1
2.2 SITE INVESTIGATIONS.....	2
2.2.1 Previous Site Investigations.....	2
2.2.2 Recent Site Investigation.....	2
2.3 PROPOSED DEVELOPMENT.....	3
2.4 RISK ASSESSMENT.....	4
3.0 OBJECTIVES.....	4
4.0 PROPOSED SOIL MANAGEMENT PROCEDURES.....	5
4.1 SOIL MANAGEMENT PROCEDURES FOR SITE CONSTRUCTION.....	5
4.1.1 Dust Control.....	5
4.1.2 Erosion Control.....	5
4.1.3 Soil Stockpile Management.....	6
4.1.4 Soil Disposal.....	6
4.1.5 Site Access Control.....	6
4.2 SOIL MANAGEMENT FOLLOWING SITE DEVELOPMENT.....	6
5.0 MAINTENANCE OF SITE COVER.....	7
6.0 CONTINGENCY PLAN.....	7
7.0 HEALTH AND SAFETY GUIDELINES.....	7
8.0 FACILITY MAP.....	8
9.0 REFERENCES.....	9

TABLES

Table 1	Summary of Analytical Results - Metals Detected in Soil Samples
Table 2	Summary of Analytical Results - Volatile Organic Compounds Detected in Soil Samples
Table 3	Summary of Analytical Results - Polynuclear Aromatic Compounds Detected in Soil Samples
Table 4	Summary of Analytical Results - Other Maher Parameters
Table 5	Summary of Analytical Results - Metals Detected in Grab Groundwater Samples
Table 6	Summary of Health Risk Assessment Results

TABLE OF CONTENTS
(Continued)

FIGURES

- Figure 1 Site Location Map
- Figure 2 Site Plan Showing Sampling Locations

APPENDIXES

- Appendix A Data Summaries from Previous Investigations
- Appendix B Site Maps Illustrating Alternative Storm Drainage Systems



SOIL MANAGEMENT PLAN
Imperial Weitz Parking Lots for the
Giants Pacific Bell Ball Park
Area E - Port of San Francisco Property
San Francisco, California

1.0 INTRODUCTION

Geomatrix Consultants, Inc. (Geomatrix) has prepared this Soil Management Plan (SMP) on behalf of Imperial Weitz, LLC for the proposed 14-acre parking lot for the Giants' Pacific Bell Ball Park. The proposed parking lot site is located south of China Basin Channel and east of Third Street in San Francisco, California (the site; Figure 1). The site is part of a total of approximately 36 acres of parking to be developed by Imperial Weitz south of China Basin Channel and has been referred to as Area E in previous environmental documents prepared by Geomatrix on behalf of Imperial Weitz.

2.0 BACKGROUND

Imperial Weitz is proposing to construct a paved parking lot on the site. A site history review, environmental investigation and risk evaluation were performed to meet Article 20 requirements and assess potential risks to construction worker and site visitor health associated with soil and groundwater quality at the site. The following summarizes the results of the site history review, environmental investigations, and risk assessment, and describes the proposed parking lot development.

2.1 SITE SETTING AND HISTORICAL USAGE

The approximately 19 acre site is currently owned by the Port of San Francisco (the Port). The subject area was originally marshlands and shallow tidal flats bordering San Francisco Bay. It was filled between 1877 and 1913; the source of the fill is unknown but likely included construction debris and rubble from the 1906 earthquake and cut material from nearby hills and construction areas.

Historical site uses include: railroad trackage and support structures for rail-related activities, parking and shipping, and truck maintenance. H&H Shipping Service Company, Inc. (H&H) occupied the northeastern corner of the site from 1950 to 1996. H&H used the area for vehicle parking and offices, and maintained a tank cleaning area and drum storage unit. No known underground storage tanks (USTs) have been identified on the site. Recently, the site has been

leased by multiple tenants. Tenant uses consist of a recycling center, an automobile sales center, the Mission Rock Recovery Center, a moving company, maritime offices, and automobile storage.

2.2 SITE INVESTIGATIONS

2.2.1 Previous Site Investigations

Burlington Northern Santa Fe Railway Company ("the Railroad") conducted Phase I and Phase II Environmental Assessments of property formerly operated by the Railroad located east of Third Street, between Sixteenth Street and China Basin Channel; this property included the western half of the site. The scope of the Railroad's investigations included one soil boring in the southern portion of the site. Soil samples were collected at depths of 0.5, 5, and 8 feet bgs and analyzed for total petroleum hydrocarbons as gasoline (TPHg), TPH as motor oil (TPHmo), lead, nickel, arsenic, chromium, cadmium, and zinc. Results of chemical analyses on these soil samples indicated that several metals were present at concentrations exceeding typical regional background concentrations (Geomatrix, March 1999).

In addition, HLA has performed an investigation of the former H&H Shipping parcel located in the northeast corner of the site (HLA; 1999). Seventeen soil samples were collected and analyzed for metals, TPH as diesel (TPHd), TPHg, oil and grease, volatile organic compounds (VOCs), polychlorinated biphenyls (PCBs), and polynuclear aromatic hydrocarbons (PNAs). Five groundwater samples were collected and one or more samples were analyzed for metals, TPHd, TPHg, benzene, toluene, ethylbenzene, xylenes [BTEX], PCBs, and PNAs. Several soil samples contained PNAs and metals; very low concentrations of some aromatic hydrocarbons and PCBs were detected in a few soil samples. The groundwater samples contained low to trace concentrations of several metals. Filtered groundwater samples did not contain PNAs; however, unfiltered samples contained low concentrations of several PNA compounds. PCBs and BTEX were not detected in the groundwater samples. Summary tables for the soil and groundwater analysis results of the H&H investigation are contained in Appendix A.

2.2.2 Recent Site Investigation

In April 1999, Geomatrix installed 8 soil borings and collected 16 soil samples (two soil samples per boring) and 2 groundwater samples (from 2 of the 8 locations) for chemical analysis. Sampling locations are illustrated on Figure 2. Primary chemicals detected in soil were PNAs and some metals (i.e., antimony, arsenic, copper, lead, nickel, and mercury). Soil sample results from the recent investigation are summarized in Tables 1 through 5. Several

metals were detected in groundwater; however, chemical concentrations were generally low to non-detect (Table 6). PNAs were not detected in the groundwater samples.

2.3 PROPOSED DEVELOPMENT

The proposed development for the subject area is asphalt paved parking. Two alternatives for storm drainage are being considered, as described below. Figures illustrating the two alternatives for the storm drainage system are contained in Appendix B.

Alternative 1

This alternative for the drainage system consists of a series of storm drainage lines and catch basins to collect and transport storm water from the parking lot site to the main City box culvert located on Channel Street, west of Fourth Street. During a 5 year storm event, the City system could reach capacity and overflows would result. Overflows from the parking lot site would be diverted to a small treatment plant to be located east of Fourth Street, near China Basin Channel. Under this alternative, Area E will be entirely paved with asphalt and surrounded by a 3- to 4-foot fence.

The catch basins will be installed in excavations with aerial dimensions of approximately 4 feet by 4 feet and extending to depths of 4 to 6 feet. Trenches will be excavated to install the piping; the trenches are anticipated to be approximately 2 to 3 feet wide and will extend between 4 to 6 feet below grade. Estimated maximum excavation depth for the piping system is 6 feet bgs. The parking area will be graded and bermed to enhance flow to each of the catch basins, and paved with asphaltic concrete.

Alternative 2

This alternative includes perimeter grassy drainage swales to collect and drain storm water overflows.

The parking area will contain a storm drain system to collect surface water runoff. The storm drain system will consist of a network of catch basins and drainage swales to collect storm water on the parking lot. The storm water will be conveyed through a series of pipes and the drainage swales to one point of discharge. The discharge pipe will collect into one main and flow into the City box sewer in Channel Street near Fourth Street.

The catch basins will be installed in excavations with aerial dimensions of approximately 4 feet by 4 feet and extending to depths of 4 to 6 feet. Trenches will be excavated to install the

pipings; the trenches are anticipated to be approximately 2 to 3 feet wide and will extend between 4 to 6 feet below grade. Estimated maximum excavation depth for the piping system is 6 feet bgs. The swales will be approximately 32 feet in width and 2 to 3 feet in depth. The swales will be covered with a geotextile fabric and grass. The parking area will be graded and bermed to enhance flow to each of the catch basins, and paved with asphaltic concrete.

2.4 RISK ASSESSMENT

A health risk assessment (HRA) was conducted to evaluate the potential human health risks associated with the presence of chemicals in soil and groundwater assuming future use of the site as a parking lot with grassy swales (Geomatrix, May 1999). Potential noncarcinogenic hazard indexes and theoretical lifetime excess cancer risks were estimated for future on-site construction workers and future on-site visitors assuming conservative estimates of human exposure. Future on-site construction workers may be exposed to chemicals in soil across the site to the depth required for installation of the storm drain system or in groundwater if encountered in excavation areas. Following construction, potential exposure to future on-site visitors would be limited to exposed soil in the grass-covered swale areas.

The results of the HRA indicate that the presence of chemicals in soil and groundwater at the site should not pose an unacceptable noncarcinogenic or carcinogenic risk to future on-site construction workers and visitors. A summary table for the HRA results is provided as Table 7. Based on these results, it was also concluded that potential risks to nearby residents during construction and future on-site maintenance workers and trespassers after construction would also not be of concern.

3.0 OBJECTIVES

As described above, the results of the HRA indicate that chemicals in site soil do not present an unacceptable human health risk. However, dust from a construction site can present a nuisance if not controlled. Likewise, erosion of on-site soil during construction activities can increase the turbidity of surface water run-off.

Therefore, the objectives of the SMP are to:

- provide guidelines for soil handling, stockpiling, dust and erosion minimization and, if needed, soil disposal during site construction activities for the proposed parking lot; and

- describe procedures for soil management following site construction for the duration of the use of the Site as a parking lot.

4.0 PROPOSED SOIL MANAGEMENT PROCEDURES

The following two sections describe the soil management procedures that will be implemented during and following site construction.

4.1 SOIL MANAGEMENT PROCEDURES FOR SITE CONSTRUCTION

The following procedures will be implemented during site construction activities to minimize dust and control erosion.

4.1.1 Dust Control

The dust control measures to be implemented at the site correspond to the PM₁₀ control measures recommended by the Bay Area Air Quality Management District (BAAQMD) in their California Environmental Quality Act Guidelines. These measures consist of:

- Water all active construction areas at least twice daily or as necessary to prevent visible dust plumes from migrating outside of the site limits.
- Mist or spray water while loading transportation vehicles.
- Minimize drop heights while loading transportation vehicles.
- Use tarpaulins or other effective covers for trucks carrying soils that travel on public streets.
- Pave, apply water 3 times daily, or apply non-toxic soil stabilizers on all unpaved access roads, parking areas, and staging areas.
- Sweep all paved access routes parking areas and staging areas daily, if visibly soiled.
- Sweep street daily if visible soil material is carried onto public streets from the site.

4.1.2 Erosion Control

A Stormwater Pollution Prevention Plan (SWPPP) will be developed by the site contractor prior to initiation of Site work that details procedures for minimizing erosion. The SWPPP will include elements such as silt traps and hay bales to minimize surface water runoff from the Site into storm drains or the San Francisco Bay, berms to control Site runoff, and covering soil stockpiles during the rainy season (November through March) to minimize sediment runoff.

4.1.3 Soil Stockpile Management

Temporary stockpiling of excavated soil may be necessary throughout site construction. Soil stockpiled at the Site will be lightly sprayed with water as needed to minimize dust. To the extent practical, the soil stockpiles will be covered with plastic sheeting or other similar material at times when not in active use. When a soil stockpile is uncovered during the rainy season, it will be surrounded by hay bales and/or silt traps to minimize sediment runoff.

4.1.4 Soil Disposal

Site development has been designed to minimize the generation of excess soil; therefore, soil requiring off-site disposal is not anticipated. Although not anticipated at this time, if excess soil is generated from the site, the excess soil will be profiled to determine appropriate disposal options. Handling and disposal of the soil will be conducted in accordance with all applicable state and federal laws.

Based on chemical analysis results of soil samples collected from the site, total metal and organic concentrations are less than the Total Threshold Limit Concentrations (TTLCs) for designation as California Hazardous Waste. However, additional solubility testing of some of the metals (e.g., lead) would likely be required by disposal facilities to better assess the waste profile for the soil.

4.1.5 Site Access Control

The construction site will be fenced to control pedestrian or vehicular entry, except at controlled points (i.e., gates). Gates will be closed and locked during non-construction hours. "No-trespassing" signs will be posted every 500 feet along the fencing.

4.2 SOIL MANAGEMENT FOLLOWING SITE DEVELOPMENT

Following site development, the soil will be covered by asphalt pavement or grass (in the swale areas) and it is unlikely that the soil will be accessed, with the exception of future maintenance work on subsurface utilities. The HRA assessed possible health risks to future maintenance workers at the parking lot and concluded that chemicals in soil at the site should not pose an unacceptable carcinogenic or noncarcinogenic risk (Geomatrix, May 1999). Soil management procedures during future site maintenance work requiring soil excavation will be as described in Section 4.1 of this SMP; if waste soil is generated, the soil will be disposed in accordance with the procedures described in Section 4.1.4.

5.0 MAINTENANCE OF SITE COVER

Procedures in this section are applicable only if Alternative 2 is selected for the storm drainage system.

Although the HRA concluded that soil in the grass-covered swale area would not present an unacceptable risk to human health for parking lot visitors or trespassers, it is prudent that the grass-covered swale areas be well maintained. Therefore, the swale areas will be inspected monthly during the baseball season, and quarterly during the off-season to visually observe the condition of the grass cover. Large areas of exposed soil (e.g., areas larger than several feet in diameter) should be reseeded as quickly as practical. A log of the parking area inspections ("Inspection Log") will be maintained at the site and will include written comments on the condition of the grass cover, areas requiring repairs, and repair dates.

Annual inspections of the paved parking areas will be performed to observe whether breaches in the pavement that may allow prolonged access to site soil are visible. If observed, the breach would be repaired such that the soil cover is maintained. Results of the annual inspections of the paved parking areas will be documented in the Inspection Log, described above.

6.0 CONTINGENCY PLAN

A Contingency Plan for this site is not warranted. The purpose of a Contingency Plan is to present response actions to an emergency situation. The results of the HRA indicate that exposure to site soil or groundwater while breaches in the pavement or grassy areas are being repaired would not present a situation requiring an emergency response.

7.0 HEALTH AND SAFETY GUIDELINES

A health and safety plan for site construction will be developed by the site contractor before initiation of the development activities. The results of the HRA indicate that the presence of chemicals in soil and groundwater at the site should not pose an unacceptable health risk to future construction workers or nearby receptors during construction or future maintenance workers, visitors or trespassers after construction. Therefore, a health and safety plan for known chemical hazards at the Site is not warranted, and the health and safety plan will focus on physical hazards. Additionally, contingency actions for encountering unanticipated buried hazards (e.g., drums, or other containers) will also be included in the health and safety plan.



8.0 FACILITY MAP

The final construction plan for the Site development is not complete. A copy of this plan will be forwarded to the SFDPH as an addendum to this SMP once it has been finalized.



9.0 REFERENCES

Geomatrix Consultants, Inc., 1999, Site Use History and Article 20 Sampling Program, March.

Harding Lawson Associates, 1999, RCRA Closure Certification Report, Former H&H Ship Service Facility, San Francisco, California, February 4.

TABLE 1
SUMMARY OF ANALYTICAL RESULTS
METALS DETECTED IN SOIL SAMPLES¹

Proposed Imperial Parking Area
 Area E - Port of San Francisco Property
 South of China Basin Channel, San Francisco, California

Concentrations are reported in milligrams per kilogram (mg/kg)

Sample I.D.	Sample Interval (feet bgs)	Antimony	Arsenic	Barium	Beryllium	Cadmium	Total Chromium	Cobalt	Copper	Lead	Mercury	Molybdenum	Nickel	Selenium	Silver	Thallium	Vanadium	Zinc
GMX-1-1.0	0.5 - 1.0	<5.0	<0.35	27	<5.0	<5.0	120	16	9.6	8.7	<0.1	<5.0	220	<5.0	<5.0	<5.0	36	37
GMX-1-4.5	4.5 - 5.0	<5.0	2.5	35	<5.0	<5.0	200	24	12	13	<0.1	<5.0	370	<5.0	<5.0	<5.0	20	32
GMX-2-1.0	0.5 - 1.0	<5.0	<0.35	170	<5.0	<5.0	62	15	50	220	0.13	<5.0	71	<5.0	<5.0	<5.0	49	150
GMX-2-4.5	4.5 - 5.0	<5.0	<0.35	160	<5.0	<5.0	91	17	31	54	<0.1	18	110	<5.0	<5.0	<5.0	40	83
GMX-3-1.0	0.5 - 1.0	33	64	84	<5.0	<5.0	35	12	93	250	0.28	<5.0	140	<5.0	<5.0	<5.0	20	250
GMX-3-4.5	4.5 - 5.0	15	7.7	76	<5.0	<5.0	110	14	44	98	0.23	<5.0	240	<5.0	<5.0	<5.0	24	130
GMX-4-1.0	0.5 - 1.0	<5.0	1.8	170	<5.0	<5.0	42	16	40	110	0.16	<5.0	100	<5.0	<5.0	<5.0	31	94
GMX-4-4.5	4.5 - 5.0	<5.0	<0.35	100	<5.0	<5.0	36	8.7	26	53	<0.1	<5.0	40	<5.0	<5.0	<5.0	27	60
GMX-5-1.0	0.5 - 1.0	<5.0	0.47	26	<5.0	<5.0	21	<5.0	7.1	42	<0.1	<5.0	20	<5.0	<5.0	<5.0	17	69
GMX-5-7.0	4.5 - 5.0	<5.0	2.5	47	<5.0	<5.0	11	<5.0	13	60	0.57	<5.0	12	<5.0	<5.0	<5.0	12	35
GMX-6-1.0	0.5 - 1.0	<5.0	<0.35	360	<5.0	<5.0	17	12	66	17	<0.1	<5.0	21	<5.0	<5.0	<5.0	28	40
GMX-6-4.5	4.5 - 5.0	<5.0	<0.35	210	<5.0	<5.0	43	14	46	62	0.18	<5.0	59	<5.0	<5.0	<5.0	29	55
GMX-7-1.0	0.5 - 1.0	<5.0	10	160	<5.0	<5.0	21	5.3	93	290	5.7	<5.0	28	<5.0	<5.0	<5.0	17	320
GMX-7-5.0	4.5 - 5.0	<5.0	<0.35	180	<5.0	<5.0	87	21	35	750	<0.1	<5.0	250	<5.0	<5.0	<5.0	29	160
GMX-8-1.0	0.5 - 1.0	<5.0	<0.35	680	<5.0	<5.0	21	32	130	18	<0.1	<5.0	34	<5.0	<5.0	<5.0	40	49
GMX-8-4.5	4.5 - 5.0	<5.0	5	100	<5.0	<5.0	6.8	<5.0	21	61	<0.1	<5.0	9.1	<5.0	<5.0	<5.0	12	41
Background ²		5.5	19.1	323	1	2.7	99	22	69	16	0.4	7.4	120	5.6	1.8	27	74	106
95% UTL		25.7	45.7	572.3	5.0	5.0	190.0	32.8	133.1	602.0	4.0	14.0	379.8	5.0	5.0	5.0	53.7	311.7
95% UTL > Background?		Yes	Yes	Yes	NA	NA	Yes	Yes	Yes	Yes	Yes	Yes	Yes	NA	NA	NA	No	Yes

Note:

¹ Soil samples collected by Geomatrix Consultants, Inc. and analyzed by Entech Analytical Laboratories of Sunnyvale, California, for Title 22 metals using EPA Methods 6000/7000 Series.

² Background = Lawrence Berkeley National Laboratory, 1995.

Abbreviations:

feet bgs = feet below ground surface.

< = analyte not detected at or above method detection limit shown.

NA = not applicable; sample results below detection limit reported by the analytical laboratory.

95% UTL = 95 percent upper tolerance limit.



TABLE 2
SUMMARY OF ANALYTICAL RESULTS
VOLATILE ORGANIC COMPOUNDS DETECTED IN SOIL SAMPLES¹
Proposed Imperial Parking Area
Area E - Port of San Francisco Property
South of China Basin Channel, San Francisco, California
Concentrations are reported in milligrams per kilogram (mg/kg)

Sample I.D.	Sample Interval (feet bgs)	Toluene	Ethylbenzene	Xylenes	1,2,4-Trimethylbenzene
GMX-1-1.0	0.5 - 1.0	0.030	<0.005	0.029	0.010
GMX-1-4.5	4.5 - 5.0	0.008	<0.005	<0.005	<0.005
GMX-2-1.0	0.5 - 1.0	0.013	<0.005	0.009	0.005
GMX-2-4.5	4.5 - 5.0	0.007	<0.005	<0.005	<0.005
GMX-3-1.0	0.5 - 1.0	0.014	<0.005	0.006	<0.005
GMX-3-4.5	4.5 - 5.0	0.023	<0.005	0.018	0.014
GMX-4-1.0	0.5 - 1.0	0.020	<0.005	0.030	<0.005
GMX-4-4.5	4.5 - 5.0	<0.005	<0.005	<0.005	<0.005
GMX-5-1.0	0.5 - 1.0	0.027	<0.005	0.014	0.008
GMX-5-7.0	4.5 - 5.0	<0.005	<0.005	<0.005	<0.005
GMX-6-1.0	0.5 - 1.0	0.037	<0.005	0.056	0.036
GMX-6-4.5	4.5 - 5.0	<0.005	<0.005	<0.005	<0.005
GMX-7-1.0	0.5 - 1.0	0.008	<0.005	0.009	<0.005
GMX-7-5.0	4.5 - 5.0	0.021	<0.005	0.009	<0.005
GMX-8-1.0	0.5 - 1.0	<0.005	0.023	0.046	<0.005
GMX-8-4.5	4.5 - 5.0	0.008	<0.005	0.010	<0.005

Note:

¹ Soil samples collected by Geomatrix Consultants, Inc. and analyzed by Entech Analytical Laboratories of Sunnyvale, California, for VOCs using EPA Method 8260B.

Abbreviations:

feet bgs = feet below ground surface.

<= indicates result less than the laboratory detection limit indicated.

VOCs = volatile organic compounds.

TABLE 3
SUMMARY OF ANALYTICAL RESULTS
POLYNUCLEAR AROMATIC COMPOUNDS DETECTED IN SOIL SAMPLES¹

Proposed Imperial Parking Area
 Area E - Port of San Francisco Property
 South of China Basin Channel, San Francisco, California

Concentrations are reported in milligrams per kilogram (mg/kg)

Sample I.D.	Sample Interval (feet bgs)	Acenaphthene	Acenaphthylene	Anthracene	Benzo(a)anthracene	Benzo(b)fluoranthene	Benzo(k)fluoranthene	Benzo(g,h,i)perylene	Benzo(a)pyrene	Chrysene	Dibenzo(a,h)anthracene	Fluoranthene	Fluorene	Indeno(1,2,3-cd)pyrene	Naphthalene ²	Phenanthrene	Pyrene
GMX-1-1.0	0.5 - 1.0	<0.04	<0.04	<0.04	<0.04	<0.002	<0.04	<0.04	<0.04	0.089	<0.04	<0.04	<0.04	<0.04	<0.04	<0.04	0.058
GMX-1-4.5	4.5 - 5.0	<0.01	<0.01	0.023	<0.01	0.029	<0.01	<0.01	<0.01	<0.01	<0.01	0.025	<0.01	<0.01	<0.01	0.024	0.029
GMX-2-1.0	0.5 - 1.0	<0.02	0.024	0.103	0.141	<0.002	<0.02	<0.02	<0.02	0.08	<0.02	0.363 ³	<0.02	<0.02	<0.02	0.105	0.415 ³
GMX-2-4.5	4.5 - 5.0	<0.002	0.0024	0.0066	0.022	0.022	0.0048	<0.002	<0.002	0.011	<0.002	0.023	<0.002	<0.002	0.0058	0.0068	0.025
GMX-3-1.0	0.5 - 1.0	<0.02	<0.02	0.078	0.114	<0.002	<0.02	<0.02	<0.02	0.064	<0.02	0.169	<0.02	<0.02	<0.02	0.08	0.16
GMX-3-4.5	4.5 - 5.0	<0.01	<0.01	<0.01	0.025	0.04	<0.01	<0.01	<0.01	0.014	<0.01	0.036	<0.01	<0.01	<0.01	0.024	0.045
GMX-4-1.0	0.5 - 1.0	<0.04	<0.04	<0.04	0.072	<0.04	<0.04	<0.04	<0.04	0.061	<0.04	0.142	<0.04	<0.04	<0.04	0.071	0.183
GMX-4-4.5	4.5 - 5.0	0.053	0.107	0.129	<0.02	<0.2	<0.2	<0.2	0.295	0.18	<0.2	0.628 ⁴	<0.02	<0.2	0.057	0.668 ⁴	0.777 ⁴
GMX-5-1.0	0.5 - 1.0	<0.02	<0.02	<0.02	<0.002	<0.02	<0.02	<0.02	<0.02	<0.02	<0.02	0.032	<0.02	<0.02	<0.02	0.02	0.034
GMX-5-7.0	4.5 - 5.0	<0.002	<0.002	0.026	<0.002	<0.002	<0.002	<0.002	<0.002	0.004	<0.002	0.011	<0.002	<0.002	<0.002	0.026	0.013
GMX-6-1.0	0.5 - 1.0	<0.04	<0.04	<0.04	0.205	<0.04	<0.04	<0.04	<0.04	<0.04	<0.04	0.046	<0.04	<0.04	<0.04	0.06	0.107
GMX-6-4.5	4.5 - 5.0	<0.01	<0.01	0.029	0.122	0.1	0.023	0.038	0.072	0.056	<0.01	0.11	<0.01	0.042	<0.01	0.029	0.111
GMX-7-1.0	0.5 - 1.0	<0.02	<0.02	0.024	0.187	<0.02	<0.02	<0.02	<0.02	0.098	<0.02	0.196	<0.02	<0.02	<0.02	0.194	0.224
GMX-7-5.0	4.5 - 5.0	<0.01	<0.01	<0.01	0.031	<0.01	<0.01	<0.01	<0.01	<0.04	<0.01	<0.01	<0.01	<0.01	<0.04	0.072	<0.01
GMX-8-1.0	0.5 - 1.0	<0.04	<0.04	<0.04	<0.04	<0.04	<0.04	<0.04	<0.04	<0.04	<0.04	0.288	<0.04	<0.04	0.095	0.156	0.374
GMX-8-4.5	4.5 - 5.0	0.019	0.078	<0.01	0.314 ⁴	0.457 ⁴	<0.01	<0.01	<0.01	0.323 ⁴	<0.01	0.772 ⁴	<0.01	<0.01	<0.01	0.288 ⁴	0.680 ⁴

Notes:

¹ Soil samples collected by Geomatrix Consultants, Inc. and analyzed by Advanced Technology Laboratories of Signal Hill, California, for PNAs using EPA Method 8270 SIMS.

² Detected concentration reported as part of EPA Method 8260.

³ Results reported from a 1:100 dilution.

⁴ Results reported from a 1:50 dilution.

Abbreviations:

feet bgs = feet below ground surface.

< = indicates result less than the laboratory detection limit indicated.

PNAs = polynuclear aromatic hydrocarbons.

TABLE 4
SUMMARY OF ANALYTICAL RESULTS
OTHER MAHER PARAMETERS¹

Proposed Imperial Parking Area
Area E - Port of San Francisco Property
South of China Basin Channel, San Francisco, California

Concentrations are reported in milligrams per kilogram (mg/kg) unless noted

Sample I.D.	Sample Interval (feet bgs)	Asbestos	Cyanide	Fluoride	Total Sulfide	pH (no units)	FID (ppmv)
GMX-1-1.0	0.5 - 1.0	<1%	<0.5	<0.5	<0.5	8.4	0
GMX-1-4.5	4.5 - 5.0	NA	NA	NA	NA	NA	
GMX-2-1.0	0.5 - 1.0	NA	NA	NA	NA	NA	100
GMX-2-4.5	4.5 - 5.0	<1%	NA	NA	NA	9.4	
GMX-3-1.0	0.5 - 1.0	NA	NA	NA	NA	NA	0
GMX-3-4.5	4.5 - 5.0	<1%	<0.5	<0.5	<0.5	8.8	
GMX-4-1.0	0.5 - 1.0	<1%	NA	NA	NA	9.4	100
GMX-4-4.5	4.5 - 5.0	NA	NA	NA	NA	NA	
GMX-5-1.0	0.5 - 1.0	<1%	<0.5	<0.5	<0.5	9.1	100
GMX-5-7.0	4.5 - 5.0	NA	NA	NA	NA	NA	
GMX-6-1.0	0.5 - 1.0	NA	NA	NA	NA	NA	1100
GMX-6-4.5	4.5 - 5.0	<1%	NA	NA	NA	9.2	
GMX-7-1.0	0.5 - 1.0	NA	NA	NA	NA	NA	10
GMX-7-5.0	4.5 - 5.0	<1%	<0.5	<0.5	<0.5	9.2	
GMX-8-1.0	0.5 - 1.0	<1%	NA	NA	NA	7.7	150
GMX-8-4.5	4.5 - 5.0	NA	NA	NA	NA	NA	

Note:

¹ Soil samples collected by Geomatrix Consultants, Inc. and analyzed for pH, cyanide, total sulfide, fluoride, and asbestos using EPA Methods 9045, 9010, 9030, and 340.2M, and polarized light microscopy. Analyses performed by Entech Analytical Laboratories, Inc. of Sunnyvale, California (pH and fluoride), Advanced Technology Laboratories of Signal Hill, California (cyanide and total sulfide), and EMSL Analytical, Inc. of Milpitas, California (asbestos).

Abbreviations:

feet bgs = feet below ground surface.

< = analyte not detected at or above method detection limit shown.

NA = not analyzed.

FID = flame ionization detector.

ppmv = parts per million vapor.

TABLE 5
SUMMARY OF ANALYTICAL RESULTS
METALS DETECTED IN GRAB GROUNDWATER SAMPLES¹
 Proposed Imperial Parking Area
 Area E - Port of San Francisco Property
 South of China Basin Channel, San Francisco, California

Concentrations are reported in milligrams per liter (mg/l)

Sample I.D.	Sb	Ar	Ba	Be	Cd	Cr.Total	Co	Cu	Pb	Hg	Mo	Ni	Se	Ag	Tl	V	Zn
GMX-1 ²	0.092/ 0.1	<0.005	0.1	<0.004	<0.005	<0.005	<0.005	<0.005	<0.015	<0.0005	0.018/ 0.02	0.010/ 0.011	<0.015	<0.005	<0.002	<0.010	0.014
GMX-5	<0.005	<0.005	1.7	<0.004	<0.005	0.006	0.008	<0.005	<0.015	<0.0005	0.051	0.006	<0.015	0.034	<0.002	<0.010	0.025

Notes:

¹ Soil samples collected by Geomatrix Consultants, Inc. and analyzed by Entech Analytical Laboratories, of Sunnyvale, California for Title 22 metals using EPA Methods 6000/7000 Series.

² Second result from duplicate sample GMX-11.

Abbreviation:

< = indicates result less than the laboratory detection limit indicated.

Sb = Antimony

Ar = Arsenic

Ba = Barium

Be = Beryllium

Cd = Cadmium

Cr Total = Total Chromium

Co = Cobalt

Cu = Copper

Pb = Lead

Hg = Mercury

Mo = Molybdenum

Ni = Nickel

Se = Selenium

Ag = Silver

Tl = Thallium

V = Vanadium

Zn = Zinc



TABLE 6

SUMMARY OF HEALTH RISK ASSESSMENT RESULTS

Proposed Imperial Weitz Parking Lot Areas

Area E - Port of San Francisco Property

South of China Basin Channel, San Francisco, California

Noncancer Hazard Indexes

Scenario	Incidental Ingestion of Soil	Dermal Contact with Soil	Inhalation of Particulates	Dermal Contact with Groundwater	Hazard Index
Future On-site Construction Worker	6E-02	2E-03	8E-04	7E-03	7E-02
Future On-site Visitor	1E-02	5E-03	7E-07	NA	1E-02

Theoretical Lifetime Excess Cancer Risks

Scenario	Incidental Ingestion of Soil	Dermal Contact with Soil	Inhalation of Particulates	Dermal Contact with Groundwater	Excess Cancer Risk
Future On-site Construction Worker	3E-07	1E-08	7E-08	4E-06	4E-06
Future On-site Visitor	5E-07	3E-07	9E-10	NA	8E-07

Note:

NA = Not applicable

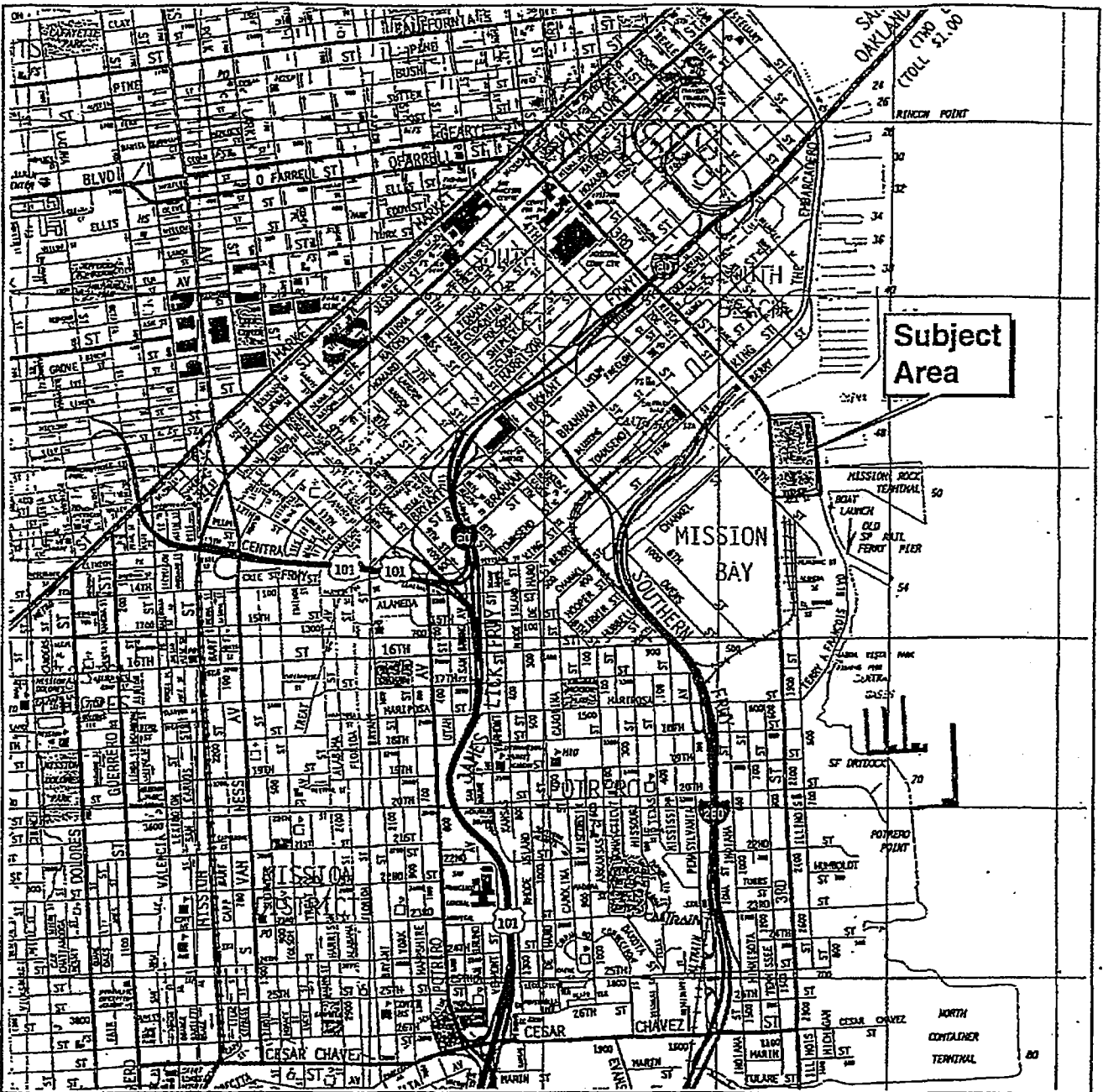

Base map from *The Thomas Guide, 1997 Golden Gate Street Guide and Directory*. Reproduced with permission granted by THOMAS BROS. MAPS. This map is copyrighted by THOMAS BROS. MAPS. It is unlawful to copy or reproduce all or any part thereof, whether for personal use or resale, without permission. All rights reserved.

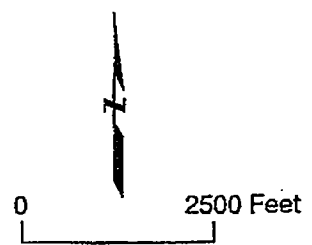

SITE LOCATION MAP
 Proposed Imperial Parking Area
 Area E - San Francisco Port Property
 South of China Basin
 San Francisco, California

Figure
 1
 Project No.
 4952

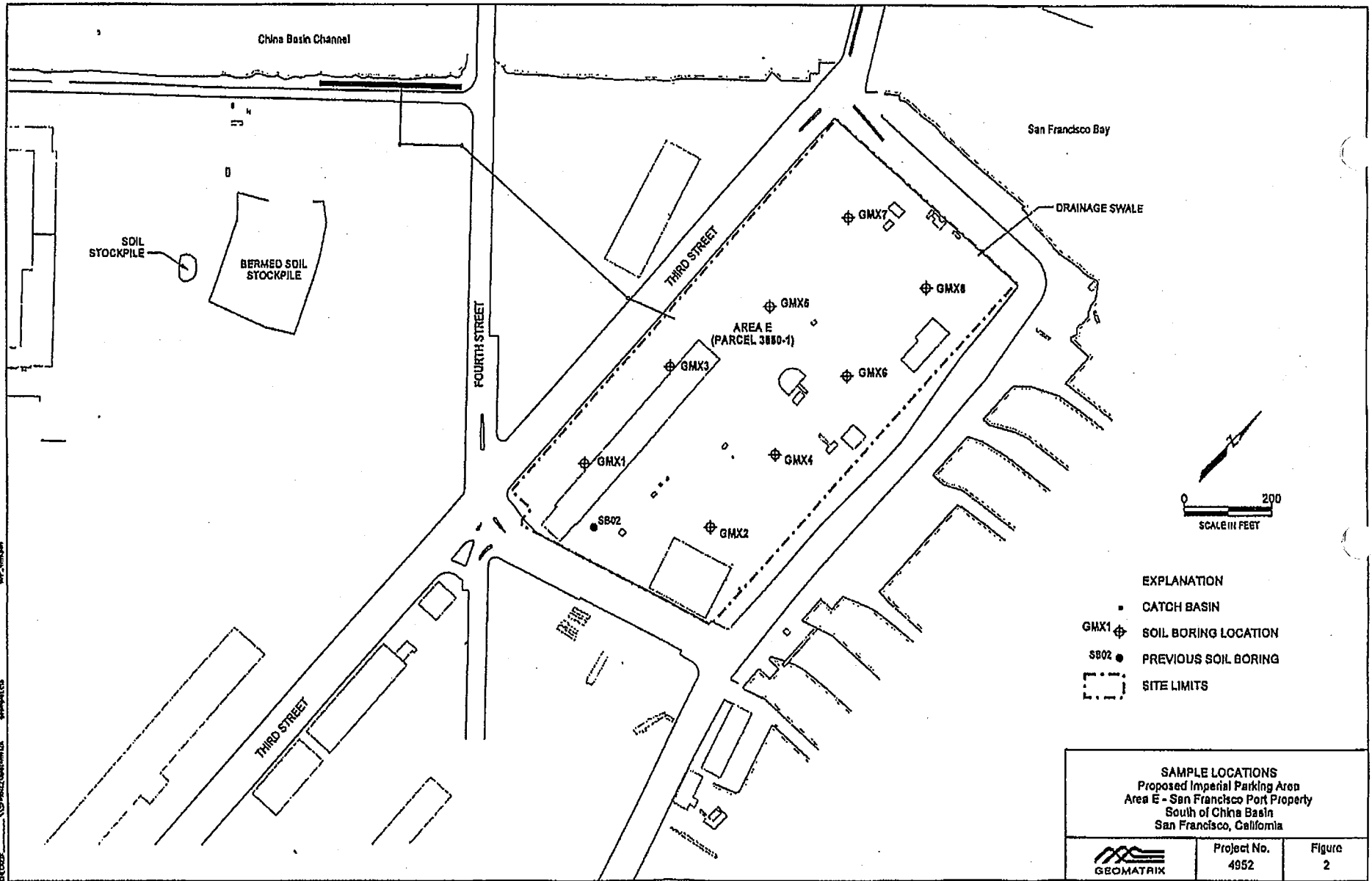



APPENDIX A

Data Summaries from Previous Investigations

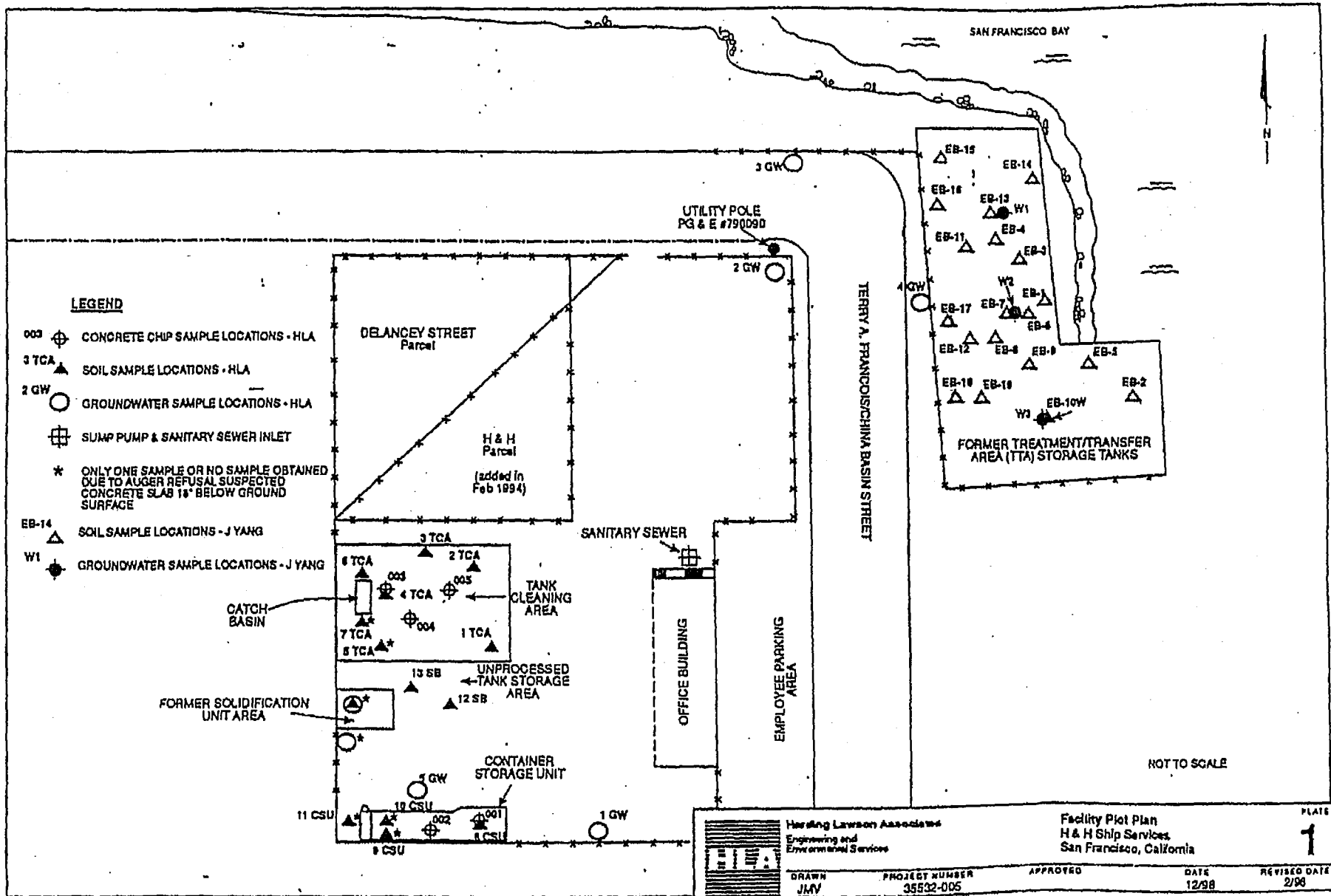

**Table 4. Summary of Chemicals Detected In Soil
Tank Cleaning Area, Container Storage Unit, and Solidification Unit
H & H Ship Service Company
San Francisco, California**

Analyte	Units	Number of Detections	Number of Analyses	Frequency of Detection	Minimum Detected Conc.	Maximum Detected Conc.	Location of Maximum Conc.
Inorganics							
Arsenic	mg/kg	16	17	94%	ND	9.2E+01	3TCA-008
Barium	mg/kg	17	17	100%	3.8E+01	6.5E+02	12SB-023
Cadmium	mg/kg	1	17	6%	ND	5.3E-01	3TCA-008
Chromium	mg/kg	17	17	100%	7.3E+00	7.0E+01	1TCA-001
Cobalt	mg/kg	17	17	100%	3.8E+00	4.0E+01	3TCA-007
Copper	mg/kg	17	17	100%	8.9E+00	1.4E+02	10CSU-021
Lead	mg/kg	18	17	94%	ND	2.1E+02	1TCA-001
Mercury	mg/kg	18	17	94%	ND	4.8E-01	2TCA-005
Nickel	mg/kg	17	17	100%	1.3E+01	3.2E+02	6TCA-014
Silver	mg/kg	3	17	18%	ND	3.0E+00	3TCA-007
Thallium	mg/kg	11	17	65%	ND	1.1E+01	1TCA-001
Vanadium	mg/kg	17	17	100%	1.8E+01	4.8E+01	5TCA-013
Zinc	mg/kg	17	17	100%	3.2E+01	2.5E+02	4TCA-011
Petroleum							
Oil and Grease (Total)	mg/kg	17	17	100%	1.1E+02	6.4E+03	4TCA-011
Oil and Grease (Non-Polar)	mg/kg	18	17	94%	ND	5.0E+03	3TCA-007
TPH-Diesel	mg/kg	17	17	100%	5.0E+00	2.1E+03	4TCA-011
TPH-Gasoline	mg/kg	4	17	24%	ND	1.0E+02	4TCA-011
Toluene	mg/kg	17	17	100%	1.2E-02	1.3E+00	3TCA-007
Ethylbenzene	mg/kg	3	17	18%	ND	6.3E-01	4TCA-011
Xylene	mg/kg	6	17	35%	ND	9.3E+00	4TCA-011
PCBs							
Aroclor 1018	mg/kg	2	17	12%	ND	1.0E-01	5TCA-013
Aroclor 1254	mg/kg	7	17	41%	ND	2.4E-01	5TCA-013
Aroclor 1260	mg/kg	3	17	18%	ND	5.5E-01	5TCA-013
PAHs							
Acenaphthene	mg/kg	2	17	12%	ND	9.3E-01	8CSU-018
Acenaphthylene	mg/kg	3	17	18%	ND	1.5E+00	8CSU-018
Anthracene	mg/kg	5	17	29%	ND	3.1E+00	8CSU-018
Benz(a)anthracene	mg/kg	11	17	65%	ND	2.4E+00	8CSU-018
Benzo(b,k)fluoranthene	mg/kg	11	17	65%	ND	2.6E+00	8CSU-018
Benzo(a)pyrene	mg/kg	10	17	59%	ND	1.8E+00	8CSU-018
Benzo(g,h,i)perylene	mg/kg	10	17	59%	ND	6.6E-01	8CSU-018
Chrysene	mg/kg	11	17	65%	ND	2.3E+00	8CSU-018
Dibenz(a,h)anthracene	mg/kg	7	17	41%	ND	3.7E-01	8CSU-018
Fluoranthene	mg/kg	14	17	82%	ND	4.3E+00	8CSU-018
Fluorene	mg/kg	5	17	29%	ND	3.7E+00	8CSU-018
Indeno(1,2,3-cd)pyrene	mg/kg	9	17	53%	ND	7.0E-01	8CSU-018
Naphthalene	mg/kg	5	17	29%	ND	2.5E+00	4TCA-011
Phenanthrene	mg/kg	15	17	88%	ND	6.3E+00	8CSU-018
Pyrene	mg/kg	15	17	88%	ND	4.7E+00	8CSU-018

mg/kg Milligrams per kilogram.
Note: Only detected compounds are listed.

**Table 6. Summary of Chemicals Detected in Groundwater
Tank Cleaning Area, Container Storage Unit, and Solidification Unit
H & H Ship Service Company
San Francisco, California**

Chemical	Units	Number of Detections	Number of Analyses	Frequency of Detection	Minimum Detected Concentration	Maximum Detected Concentration	Location of Maximum Concentration
Inorganics (filtered)							
Arsenic	mg/L	1	5	20%	0.812	0.812	3GW
Barium	mg/L	5	5	100%	0.0847	0.748	3GW
Cobalt	mg/L	1	5	20%	0.0165	0.0165	2GW
Molybdenum	mg/L	1	5	20%	0.0207	0.0207	4GW
Nickel	mg/L	2	5	40%	0.0419	0.0683	2GW
Zinc	mg/L	1	5	20%	0.128	0.128	4GW
Inorganics (unfiltered)							
Arsenic	mg/L	2	4	50%	0.3	9.2	1GW
Barium	mg/L	4	4	100%	0.27	5.1	1GW
Cadmium	mg/L	3	4	75%	0.012	0.028	1GW
Chromium	mg/L	4	4	100%	0.049	1.1	3GW
Cobalt	mg/L	4	4	100%	0.31	2.5	3GW
Copper	mg/L	4	4	100%	0.056	2	2GW
Lead	mg/L	4	4	100%	0.66	5.8	2GW
Mercury	mg/L	4	4	100%	0.0017	2	4GW
Nickel	mg/L	4	4	100%	0.32	12	3GW
Thallium	mg/L	1	4	25%	0.15	0.15	1GW
Vanadium	mg/L	3	4	75%	0.061	0.47	1GW
Zinc	mg/L	4	4	100%	1	7.2	1GW
Petroleum (unfiltered)							
TPH-Diesel	mg/L	1	4	25%	2.4	2.4	1GW
PCBs (unfiltered) None Detected							
PAHs (unfiltered)							
Acenaphthylene	µg/L	1	5	20%	0.5	0.5	1GW
Anthracene	µg/L	1	5	20%	1.1	1.1	1GW
Benzo(a)anthracene	µg/L	3	5	60%	0.14	5.1	1GW
Benzo(b)fluoranthene	µg/L	1	1	100%	0.56	0.56	5GW
Benzo(k)fluoranthene	µg/L	1	1	100%	0.12	0.12	5GW
Benzo(b,k)fluoranthene	µg/L	3	4	75%	0.6	10	1GW
Benzo(a)pyrene	µg/L	3	5	60%	0.34	6.8	1GW
Benzo(g,h,i)perylene	µg/L	3	5	60%	0.5	5.5	1GW
Chrysene	µg/L	2	5	40%	7	7	1GW
Dibenz(a,h)anthracene	µg/L	1	5	20%	1.2	1.2	1GW
Fluoranthene	µg/L	3	5	60%	0.7	10	1GW
Fluorene	µg/L	1	5	20%	1.5	1.5	5GW
Indeno(1,2,3-cd)pyrene	µg/L	1	5	20%	4.2	4.2	1GW
Naphthalene	µg/L	3	5	60%	0.5	1.1	5GW
Phenanthrene	µg/L	4	5	80%	0.5	4.8	1GW
Pyrene	µg/L	4	5	80%	0.6	10	1GW
PAHs (filtered) None Detected							

mg/L Milligrams per liter.

µg/L Micrograms per liter.

ND Not detected.

NA Not available.

Note: Only detected analytes are listed.

APPENDIX B

Site Plans Illustrating Alternative Storm Drainage Systems

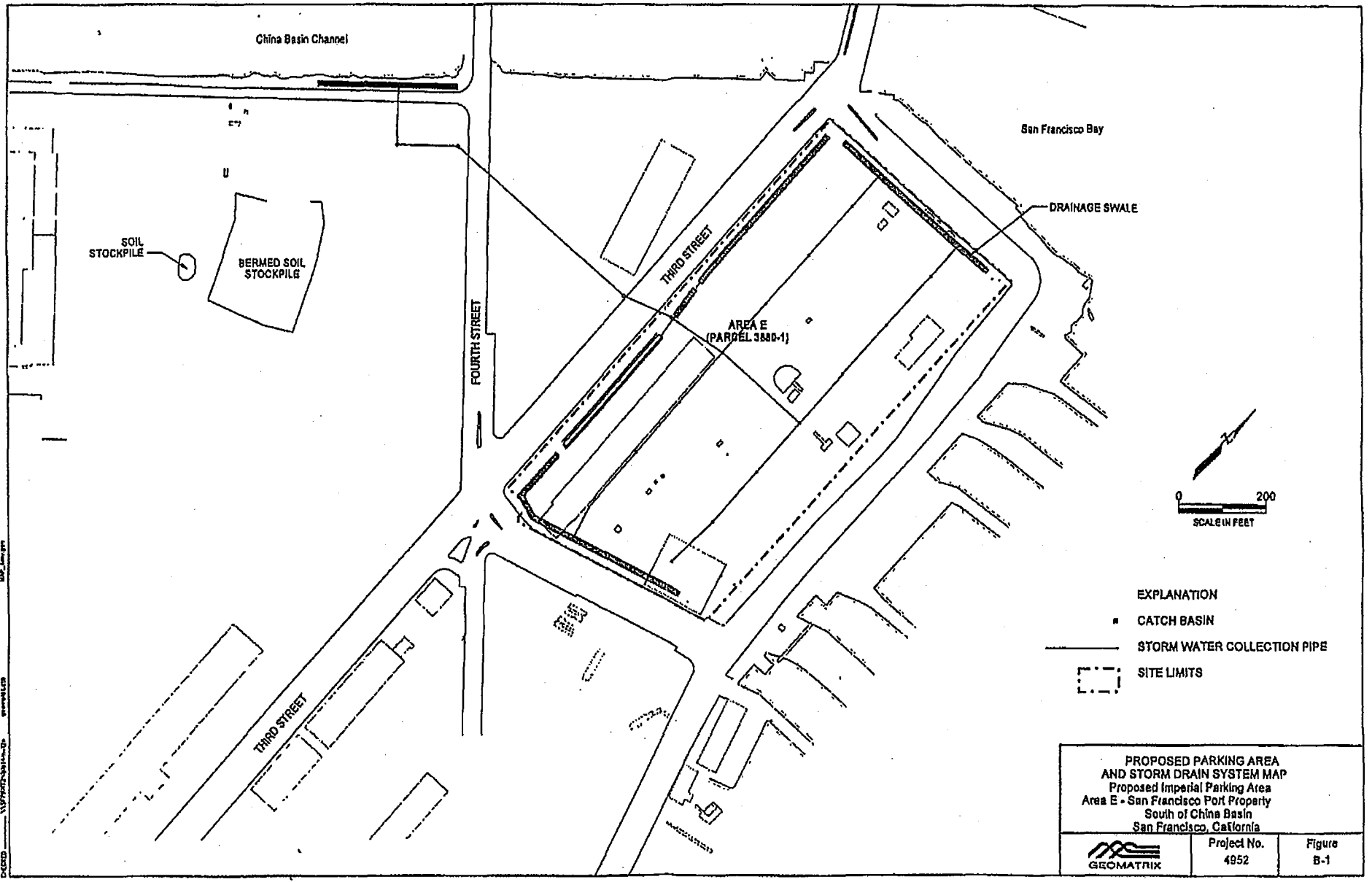

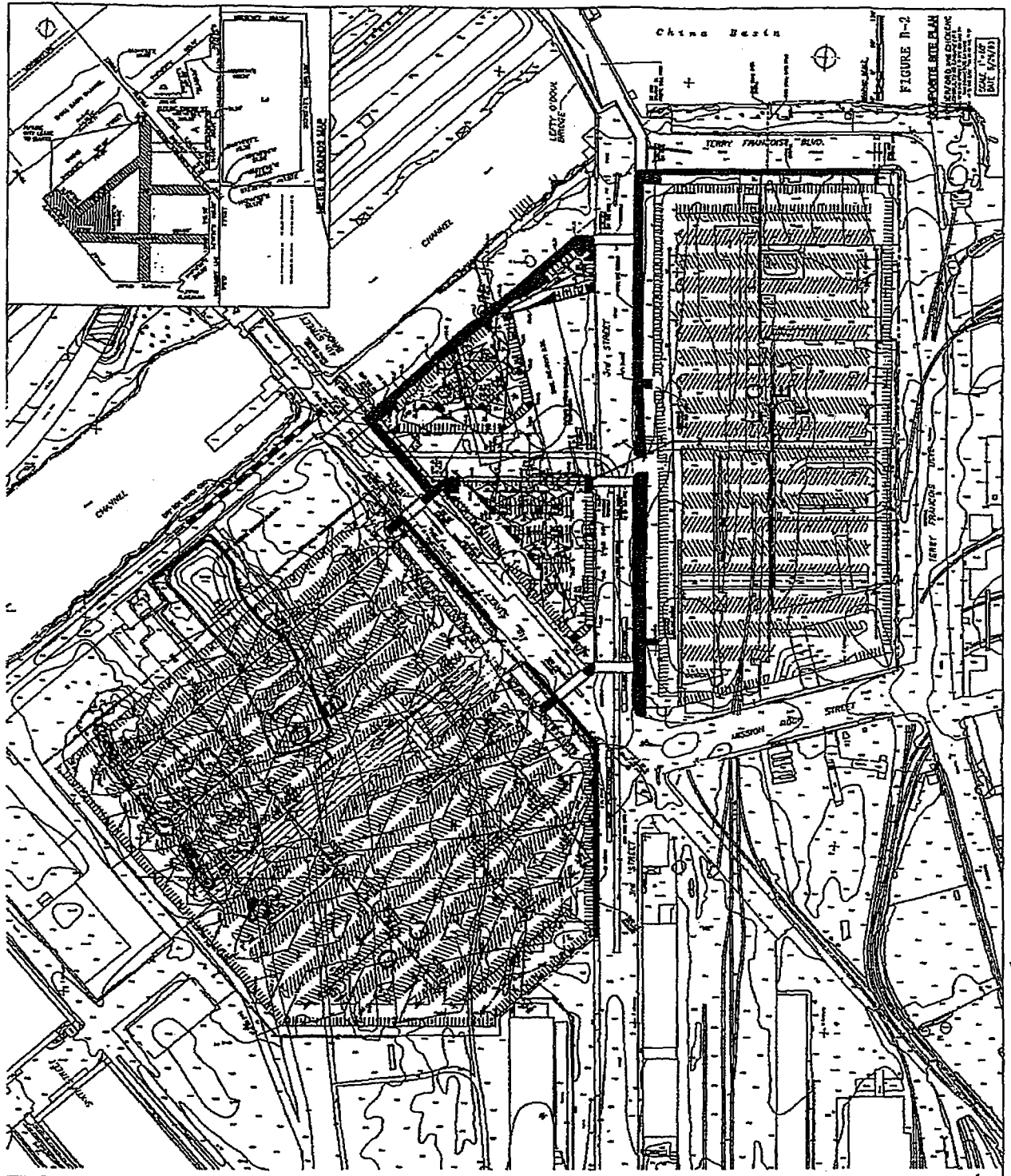

Attachment B

Use Restriction



San Francisco Assessor-Recorder
Doris M. Ward, Assessor-Recorder
DOC- 2000-G723986-00

RECORDING REQUESTED BY:
The Port of San Francisco
Ferry Building
San Francisco, California 94111

Acct 25-NO CHARGE DOCUMENT
Thursday, JAN 27, 2000 10:47:55
FRE \$0.00
Ttl Pd \$0.00 Nbr-0001346614
REEL H561 IMAGE 0199 ced/ER/1-16

WHEN RECORDED, MAIL TO:

Department of Toxic Substances Control
700 Heinz Avenue, Suite 300
Berkeley, California 94710
Attention: Mohinder S. Sandhu, P.E., Chief
Standardized Permits and Corrective
Action Branch

N/c
16

SPACE ABOVE THIS LINE RESERVED FOR RECORDER'S USE

COVENANT TO RESTRICT USE OF PROPERTY

ENVIRONMENTAL RESTRICTION

(Re: H&H Site located at Seawall Lot 337, City and County of San Francisco)

This Covenant and Agreement ("Covenant") is made by and between COVENANT TO RESTRICT USE OF PROPERTY

ENVIRONMENTAL RESTRICTION

Re: H&H Site located at Seawall Lot 337, City and County of San Francisco

This Covenant and Agreement ("Covenant") is made by and between the City and County of San Francisco, a charter city and county in trust (the "Covenantor"), the current owner, of certain property situated in the City and County of San Francisco, State of California, described in Exhibit "A", attached hereto and incorporated herein by this reference (the "Property"), and the Department of Toxic Substances Control (the

"Department"). Pursuant to Civil Code section 1471(c), the Department has determined that this Covenant is reasonably necessary to protect present or future human health or safety or the environment as a result of the presence on the land of hazardous materials as defined in Health and Safety Code ("H&SC") section 25260. The Covenantor and the Department, collectively referred to as the "Parties", therefore intend that the use of the Property be restricted as set forth in this Covenant, in order to protect human health, safety and the environment.

ARTICLE I
STATEMENT OF FACTS

1.01. The Property, totaling approximately 14 acres, is more particularly described in Exhibit "A" and depicted in Exhibit "A-1", attached hereto and incorporated herein by this reference. The Property is located in the area now generally bounded by Terry Francois Boulevard on the North and East, in the City and County of San Francisco, California.

1.02. The site was created by filling marshlands and shallow tidal flats bordering San Francisco Bay between 1877 and 1913. Sources of fill are unknown, but likely included construction/demolition debris and rubble, and rock and dirt cut from nearby hills. Historical uses of the Site include railroad tracks and related support structures, parking and shipping by truck, and truck maintenance. From 1950 to 1996 H&H Ship Service operated a hazardous waste treatment facility, including a tank cleaning area and drum storage unit, and used portions of the Property for vehicle parking and offices.

In 1978 several of the wastes managed at the H&H Ship Service facility were determined to be hazardous wastes subject to federal and state hazardous waste management regulations. Since that time, the Department of Toxic Substances Control (or its predecessor in interest, the Department of Health Services) authorized H&H Ship Service's operations pursuant to an interim status document. Under this authorization the property was a hazardous waste facility (Facility), regulated by the Department, subject to the requirements of the California Hazardous Waste Control Law ("HWCL"), at Health and Safety Code ("H&S Code") section 25100 et seq., and the federal Resource Conservation and Recovery Act ("RCRA"), at 42 U.S.C. section 6901 et seq.

The Department is requiring this Covenant pursuant to the closure requirements of the HWCL, including H&S Code section 25246 and post-closure notices provisions of Title 22 California Code of Regulations [section 66265.119(b) for interim status hazardous waste facilities], as part of the facility closure. The Department circulated a closure plan, dated August 30, 1996 and a draft Categorical Exemption pursuant to the California Environmental Quality Act, Public Resources Code section 21000 et seq for

public review and comment from December 23, 1999 to January 24, 2000. The Department approved the closure plan, closure certification report titled, *RCRA Closure Certification Report, Former H&H Ship Service Facility, San Francisco, California, dated February 4, 1999*, containing a health risk assessment, and the Categorical Exemption on January 26, 2000. Hazardous wastes, which are also hazardous materials as defined in Health and Safety Code sections 25117 and 25260, including petroleum hydrocarbons, polynuclear aromatic hydrocarbons, metals and arsenic, remain in the soil and groundwater at the Site at concentrations below those which would pose a significant human health risk under proposed reuse scenarios. The health risk assessment did not evaluate an unrestricted land use scenario, recreational use involving direct contact with soil, or potential impacts from use of groundwater. Therefore a deed restriction to limit use of the property to those exposure scenarios evaluated and found to be below acceptable risk limits is required as part of the facility closure.

1.03. As detailed in the health risk assessment within the *RCRA Closure Certification Report*, as approved by the Department on January 26, 2000, portions of the surface and subsurface soils on the Site contain hazardous wastes and hazardous materials, as defined in H&S Code section 25117 and 25260, including the following contaminants of concern: arsenic (up to 92 mg/kg) and benzo(a)pyrene (up to 2.5 mg/kg). Groundwater beneath the Property is found within 10 to 20 feet below ground surface. Dissolved arsenic was found in groundwater at up to 812 ug/l. California drinking water standards are arsenic at 50 ug/l. Because the health risk assessment did not evaluate an unrestricted land use scenario, recreational use involving direct contact with soil, or potential impacts from use of groundwater, the Department concluded that use of the Property as a residence, hospital, school for persons under the age of 21, day care center, or recreational use involving direct contact with soil would entail an unacceptable potential human health risk. The Department further concluded that the Property, subject to the restrictions of this Covenant, does not present an unacceptable threat to human safety or the environment.

ARTICLE II DEFINITIONS

2.01. Department. "Department" shall mean the California Department of Toxic Substances Control and shall include its successor agencies, if any.

2.02. Owner. "Owner" shall mean the Covenantor, its successors in interest, and their successors in interest, including heirs and assigns, who at any time hold title to all or any portion of the Property.

2.03. Occupant. "Occupant" shall mean Owners and any person or entity entitled by ownership, leasehold, or other legal relationship to the right to occupy any portion of the Property.

ARTICLE III
GENERAL PROVISIONS

3.01. Restrictions to Run With the Land. This Covenant sets forth protective provisions, covenants, restrictions, and conditions (collectively referred to as "Restrictions"), upon and subject to which the Property and every portion thereof shall be improved, held, used, occupied, leased, sold, hypothecated, encumbered, and/or conveyed. Each and every one of the Restrictions: (a) shall run with the land pursuant to H&SC sections 25202.5, and 25202.6 and Civil Code section 1471; (b) shall inure to the benefit of and pass with each and every portion of the Property, (c) shall apply to and bind the respective successors in interest to the Property, (d) are for the benefit of, and shall be enforceable by the Department, and (e) are imposed upon the entire Property unless expressly stated as applicable only to a specific portion thereof.

3.02. Binding Upon Owners/Occupants. Pursuant to Health and Safety Code section 25202.5(b), this Covenant shall be binding upon all of the owners of the land, their heirs, successors, and assignees, and the agents, employees, and lessees of the owners, heirs, successors, and assignees. Pursuant to Civil Code section 1471(b), all successive owners of the Property are expressly bound hereby for the benefit of the covenantee(s) herein. "Owner" shall include "Covenantor".

3.04. Written Notice of Hazardous Substance Release. The Owner shall, prior to the sale, lease, or rental of the Property, give written notice that a release of hazardous substances has come to be located on or beneath the Property, pursuant to Health and Safety Code section 25359.7. Such written notice shall include a copy of this Covenant.

ARTICLE IV
RESTRICTIONS

- 4.01. Prohibited Uses. The Property shall not be used for any of the following purposes:
- (a) A residence, including any mobile home or factory built housing, constructed or installed for use as residential human habitation;
 - (b) A hospital for humans;
 - (c) A public or private school for persons under 21 years of age;
 - (d) A day care center for children; or
 - (e) Recreational use involving direct contact with soil.

4.02. Soil Management

- (a) Any contaminated soils brought to the surface by grading, excavation, trenching or backfilling shall be managed in accordance with all applicable provisions of state and federal law.
- (b) If more than 50 cubic yards of any surface or subsurface soil will be disturbed, including excavation and grading, then the soil shall be evaluated for potential human health risks in compliance with Article 20 of the SF Municipal Code ("the Maher Ordinance"), and managed accordingly.

4.03. Prohibited Activities. The following activities shall not be conducted at the Property:

- (a) No raising of food (e.g., cattle, food crops, cotton, etc.) shall be permitted on the property.
- (b) No groundwater shall be extracted on the Property for purposes other than site remediation or construction dewatering without prior written approval by the Department.

4.04. Access for Department. Covenantor agrees that the Department shall have reasonable right of entry and access to the Property for inspection, monitoring, and other activities consistent with the purposes of this Covenant as deemed necessary by the Department in order to protect the public health and safety.

ARTICLE V ENFORCEMENT

5.01. Enforcement. Failure of the Covenantor and/or Owner to comply with any of the Restrictions specifically applicable to it shall be grounds for the Department, by reason of this Covenant, to require that the Covenantor and/or Owner modify or remove any improvements ("Improvements" herein shall mean all buildings, roads, driveways, and paved parking areas, constructed or placed upon any portion of the Property constructed in violation of the Restrictions.) Violation of this Covenant shall be grounds for the Department to file civil and/or criminal actions against the Covenantor and/or Owner as provided by law.

ARTICLE VI
VARIANCE, TERMINATION, AND TERM

6.01. Variance. Any Owner or, with the Owner's written consent, any Occupant of the Property or any portion thereof may apply to the Department for a written variance from the provisions of this Covenant. Such application shall be made in accordance with H&S Code section 25202.6.

6.02. Termination. Any Owner, and/or, with the Owner's written consent, any Occupant of the Property, or any portion thereof, may apply to the Department for a termination of the Restrictions or other terms of this Covenant as they apply to all or any portion of the Property. Such application shall be made in accordance with H&S Code section 25202.6.

6.03. Term. Unless ended in accordance with the Termination Paragraph above, by law, or by the Department in the exercise of its discretion, this Covenant shall continue in effect in perpetuity.

ARTICLE VII
MISCELLANEOUS

7.01. No Dedication Intended. Nothing set forth in this Covenant shall be construed to be a gift or dedication, or offer of a gift or dedication, of the Property, or any portion thereof to the general public or anyone else for any purpose whatsoever.

7.02. Department References. All references to the Department include successor agencies/departments or other successor entity.

7.03. Recordation. The Covenantor shall record this Covenant, with all referenced Exhibits, in the County of San Francisco within ten (10) days of the Covenantor's receipt of a fully executed original.

7.04. Notices. Whenever any person gives or serves any notice ("Notice" as used herein includes any demand or other communication with respect to this Covenant), each such Notice shall be in writing and shall be deemed effective: (1) when delivered, if personally delivered to the person being served or to an officer of a corporate party being served, or (2) three (3) business days after deposit in the mail, if mailed by United States mail, postage paid, certified, return receipt requested:

To Owner:

G723986

On or Before 12/31/00:

Port of San Francisco
3100 Ferry Building
San Francisco, CA 94111
Attention: Carol Bach,

With a copy to

Noreen Ambrose
Port General Counsel
Port of San Francisco
3100 Ferry Building
San Francisco, CA 94111.

After 12/31/00:

Port of San Francisco
Pier 1
San Francisco, CA 94111
Attention: Carol Bach,

With a copy to:
Noreen Ambrose
Port General Counsel
Port of San Francisco
Pier 1
San Francisco, CA 94111.

To Department:

California Environmental Protection Agency
Department of Toxic Substances Control
700 Heinz Avenue, Suite 300
Berkeley, CA 94710-2737
Attention: Branch Chief
Standardized Permits and Corrective Action Branch

Any party may change its address or the individual to whose attention a notice is to be sent by giving written notice in compliance with this paragraph.

7.05. Partial Invalidity. If any portion of the Restrictions or other term set forth herein is determined by a court of competent jurisdiction to be invalid for any reason, the surviving portions of this Covenant shall remain in full force and effect as if such portion found invalid had not been included herein.

G723986

IN WITNESS WHEREOF, the Parties execute this Covenant.

"Covenantor" CITY & COUNTY OF SAN FRANCISCO

Date: 1/26/00 By: 
DOUGLAS F. WONG
Its: Executive Director
CITY OF SAN FRANCISCO

"Department" DEPARTMENT OF TOXIC SUBSTANCES CONTROL

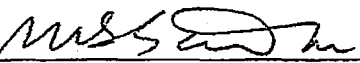
Date: 1/26/00 By: 
MOHINDER S. SANDHU
Its: Chief, Standardized Permits and Corrective Action
Branch

CALIFORNIA ALL-PURPOSE ACKNOWLEDGMENT

State of California }
County of San Francisco } ss.

On January 26, 2000, before me, Virna C. Wu, "Notary Public"
Date Name and Title of Officer (e.g., "Jane Doe, Notary Public")

personally appeared Douglas Farrell Wong
Name(s) of Signer(s)

personally known to me
 proved to me on the basis of satisfactory evidence

to be the person(s) whose name(s) is/are subscribed to the within instrument and acknowledged to me that he/she/they executed the same in his/her/their authorized capacity(ies), and that by his/her/their signature(s) on the instrument the person(s), or the entity upon behalf of which the person(s) acted, executed the instrument.

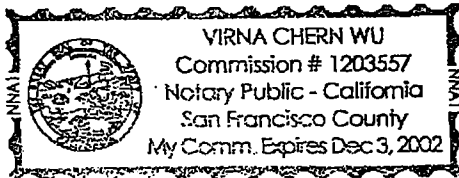

WITNESS my hand and official seal.

Virna Chern Wu
Signature of Notary Public

Place Notary Seal Above

OPTIONAL

Though the information below is not required by law, it may prove valuable to persons relying on the document and could prevent fraudulent removal and reattachment of this form to another document.

Description of Attached Document

Title or Type of Document: Environmental Restriction

Document Date: 1/26/2000 Number of Pages: 8 + 6 (Parcel A, C, D)

Signer(s) Other Than Named Above: None

Capacity(ies) Claimed by Signer

Signer's Name: Douglas Farrell Wong

- Individual
- Corporate Officer — Title(s): _____
- Partner — Limited General
- Attorney in Fact
- Trustee
- Guardian or Conservator
- Other: Port Executive Director

Signer Is Representing: Port of San Francisco

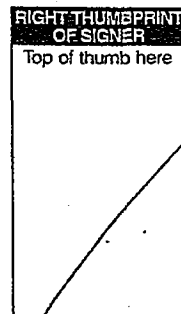

G723986

CALIFORNIA ALL-PURPOSE ACKNOWLEDGMENT

State of California }
County of San Francisco } ss.

On January 26, 2000, before me, Virna C. Wu, "Notary Public"
Date Name and Title of Officer (e.g., "Jane Doe, Notary Public")

personally appeared Mohinder Singh Sandhu
Name(s) of Signer(s)

- personally known to me
- proved to me on the basis of satisfactory evidence

to be the person(s) whose name(s) is/are subscribed to the within instrument and acknowledged to me that he/she/they executed the same in his/her/their authorized capacity(ies), and that by his/her/their signature(s) on the instrument the person(s), or the entity upon behalf of which the person(s) acted, executed the instrument.

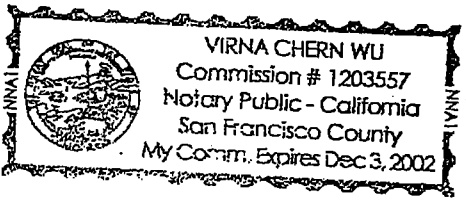

WITNESS my hand and official seal.

Virna C Wu

Place Notary Seal Above

Signature of Notary Public

OPTIONAL

Though the information below is not required by law, it may prove valuable to persons relying on the document and could prevent fraudulent removal and reattachment of this form to another document.

Description of Attached Document

Title or Type of Document: Environmental Restriction

Document Date: 01/26/2000 Number of Pages: 8+6 (Parcel A, C, D)

Signer(s) Other Than Named Above: None

Capacity(ies) Claimed by Signer

Signer's Name: Mohinder Singh Sandhu

- Individual
- Corporate Officer — Title(s): _____
- Partner — Limited General
- Attorney in Fact
- Trustee
- Guardian or Conservator
- Other: Chief, Standardized Permits & Corrective Action Branch

Signer Is Representing: Dept. of Toxic Substances Control

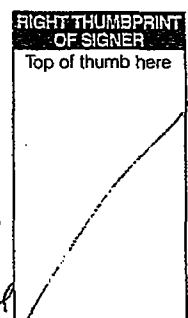

G723986

SEAWALL LOT 337

PARCEL A

ALL THAT CERTAIN REAL PROPERTY SITUATED AT THE CITY AND COUNTY OF SAN FRANCISCO, BEING A PORTION OF SEAWALL LOT 337 OF THE SAN FRANCISCO PORT AUTHORITY, DESCRIBED AS FOLLOWS; COMMENCING AT THE SOUTHWEST CORNER OF THE INTERSECTION OF TOWNSEND STREET AND DELANCEY STREET (FORMERLY FIRST STREET), SAID CORNER BEING INNER 14 OF THE INNER WATERFRONT LINE AS DESCRIBED IN THE RECORDS ON FILE AT THE OFFICE OF ENGINEERING OF THE SAN FRANCISCO PORT AUTHORITY; RUNNING THENCE ALONG SAID INNER WATERFRONT LINE AT S 3DEG 02'27" E A DISTANCE OF 2,217.59 FEET TO THE TRUE POINT OF BEGINNING; THENCE CONTINUING ALONG THE LAST AFOREMENTIONED COURSE A DISTANCE OF 149.77 FEET; THENCE AT S 86DEG 57'33" W A DISTANCE OF 38.12 FEET; THENCE AT S 3DEG 14'22" E A DISTANCE OF 31.51 FEET; THENCE AT N 86DEG 45'38" E A DISTANCE OF 55.69 FEET; THENCE AT S 3DEG 02'27" E A DISTANCE OF 120.00 FEET; THENCE AT S 86DEG 45'38" W A DISTANCE OF 55.27 FEET; THENCE AT N 3DEG 14'22" W A DISTANCE OF 120.00 FEET; THENCE AT S 86DEG 45'38" W A DISTANCE OF 40.17 FEET; THENCE AT S 3DEG 14'22" E A DISTANCE OF 120.00 FEET; THENCE AT N 86DEG 45'38" E A DISTANCE OF 40.17 FEET; THENCE AT S 3DEG 14'22" E A DISTANCE OF 48.20 FEET; THENCE AT S 86DEG 57'33" W A DISTANCE OF 142.25 FEET; THENCE AT

G723986

S 86DEG 50'57" W A DISTANCE OF 111.99 FEET; THENCE AT
N 3DEG 10'55" W A DISTANCE OF 200.00 FEET; THENCE AT
N 86DEG 57'33" E A DISTANCE OF 171.00 FEET; THENCE AT
N 3DEG 02'27" W A DISTANCE OF 149.48 FEET; THENCE AT
N 86DEG 49'20" E A DISTANCE OF 121.29 FEET TO THE TRUE POINT OF
BEGINNING, CONTAINING AN AREA OF 70,765.20 SQUARE FEET, MORE
OR LESS.

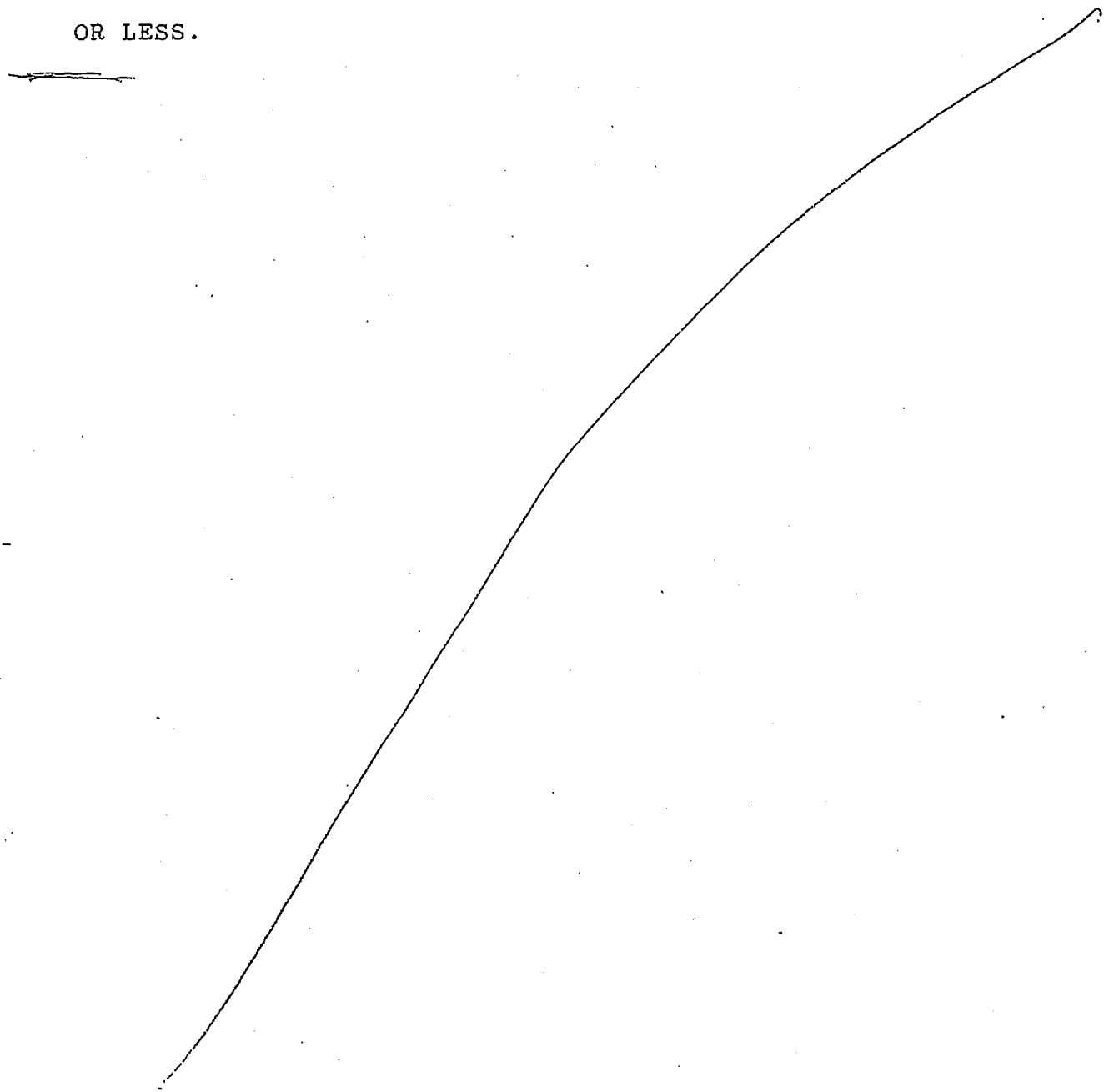

G723986

SEAWALL LOT 337

PARCEL C

BEING A PORTION OF SEAWALL LOT 337 OF THE SAN FRANCISCO PORT AUTHORITY ,CITY AND COUNTY OF SAN FRANCISCO, BRIEFLY DESCRIBED AS FOLLOWS; COMMENCING AT THE SOUTHWEST CORNER OF THE INTERSECTION OF TOWNSEND STREET AND DELANCEY STREET (FORMERLY FIRST STREET), SAID CORNER BEING INNER 14 OF THE INNER WATERFRONT LINE AS DESCRIBED IN THE RECORDS ON FILE AT THE OFFICE OF ENGINEERING OF THE SAN FRANCISCO PORT AUTHORITY; RUNNING THENCE ALONG THE AFORESAID INNER WATERFRONT LINE AT S 3DEG 02'27" E A DISTANCE OF 2,367.36 FEET TO THE TRUE POINT OF BEGINNING; THENCE AT S 48DEG 02'27" E A DISTANCE OF 25.00 FEET; THENCE AT S 3DEG 02'27" E A DISTANCE OF 13.64 FEET; THENCE AT S 86DEG 45'38" W A DISTANCE OF 55.69 FEET; THENCE AT N 3DEG 14'22" W A DISTANCE OF 31.51 FEET; THENCE AT N 86DEG 57'33" E A DISTANCE OF 38.12 FEET TO THE TRUE POINT OF BEGINNING, CONTAINING AN AREA OF 1,594.90 SQUARE FEET, MORE OR LESS.

G723986

ALSO INCLUDED IN THIS PARCEL IS A PORTION OF SEAWALL
LOT 337 BRIEFLY DESCRIBED AS FOLLOWS;
COMMENCING AT THE SOUTHWEST CORNER OF THE INTERSECTION OF
TOWNSEND STREET AND DELANCEY STREET (FORMERLY FIRST STREET)
SAID POINT BEING INNER 14 OF THE INNER WATERFRONT LINE AS
DESCRIBED IN THE RECORDS ON FILE AT THE OFFICE OF ENGINEERING
OF THE SAN FRANCISCO PORT AUTHORITY; RUNNING THENCE ALONG THE
AFORESAID INNER WATERFRONT LINE A DISTANCE OF 2,518.74 FEET;
THENCE AT N 86DEG 45'38" E A DISTANCE OF 17.66 FEET TO THE
TRUE POINT OF BEGINNING; THENCE AT S 3DEG 02'27" E DISTANCE OF
30.72 FEET; THENCE AT S 41DEG 57'33" W A DISTANCE OF 25.00
FEET; THENCE S 86DEG 57'33" W A DISTANCE OF 37.43 FEET; THENCE
AT N 3DEG 14'22" W A DISTANCE OF 48.20 FEET; THENCE AT
N 86DEG 45'38" E DISTANCE OF 55.27 FEET TO THE TRUE POINT
OF BEGINNING, CONTAINING AN AREA OF 2,509.60 SQUARE FEET, MORE
OR LESS.

G723986

SEAWALL LOT 337

PARCEL D

PARCEL D IS A TWO-STORY WAREHOUSE AND OFFICE BUILDING LOCATED AT CHINA BASIN STREET WHOSE FOOTPRINT IS BRIEFLY DESCRIBED AS FOLLOWS;

COMMENCING AT THE SOUTHWEST CORNER OF THE INTERSECTION OF TOWNSEND STREET AND DELANCEY STREET (FORMERLY FIRST STREET), SAID POINT BEING INNER 14 OF THE INNER WATERFRONT LINE AS DESCRIBED IN THE RECORDS ON FILE AT THE OFFICE OF ENGINEERING OF THE SAN FRANCISCO PORT AUTHORITY; RUNNING THENCE SOUTHERLY ALONG THE AFORESAID INNER WATERFRONT LINE AT S 3DEG 02'27" E A DISTANCE OF 2,398.74 FEET; THENCE AT N 86DEG 45'38" E A DISTANCE OF 38.02 FEET TO THE TRUE POINT OF BEGINNING; THENCE AT S 3DEG 14'22" E A DISTANCE OF 120.00 FEET; THENCE AT S 86DEG 45'38" W A DISTANCE OF 40.17 FEET; THENCE AT N 3DEG 14'22" W A DISTANCE OF 120.00 FEET; THENCE AT N 86DEG 45'38" E A DISTANCE OF 40.17 FEET TO THE TRUE POINT OF BEGINNING, CONTAINING AN AREA OF 4,820.00 SQUARE FEET, MORE OR LESS.

ALSO INCLUDED IN THIS PARCEL IS THE SECOND FLOOR OFFICE SPACE OF THE AFOREMENTIONED TWO-STORY BUILDING WITH AN AREA OF 2,414.00 SQUARE FEET, MORE OR LESS.

G723986

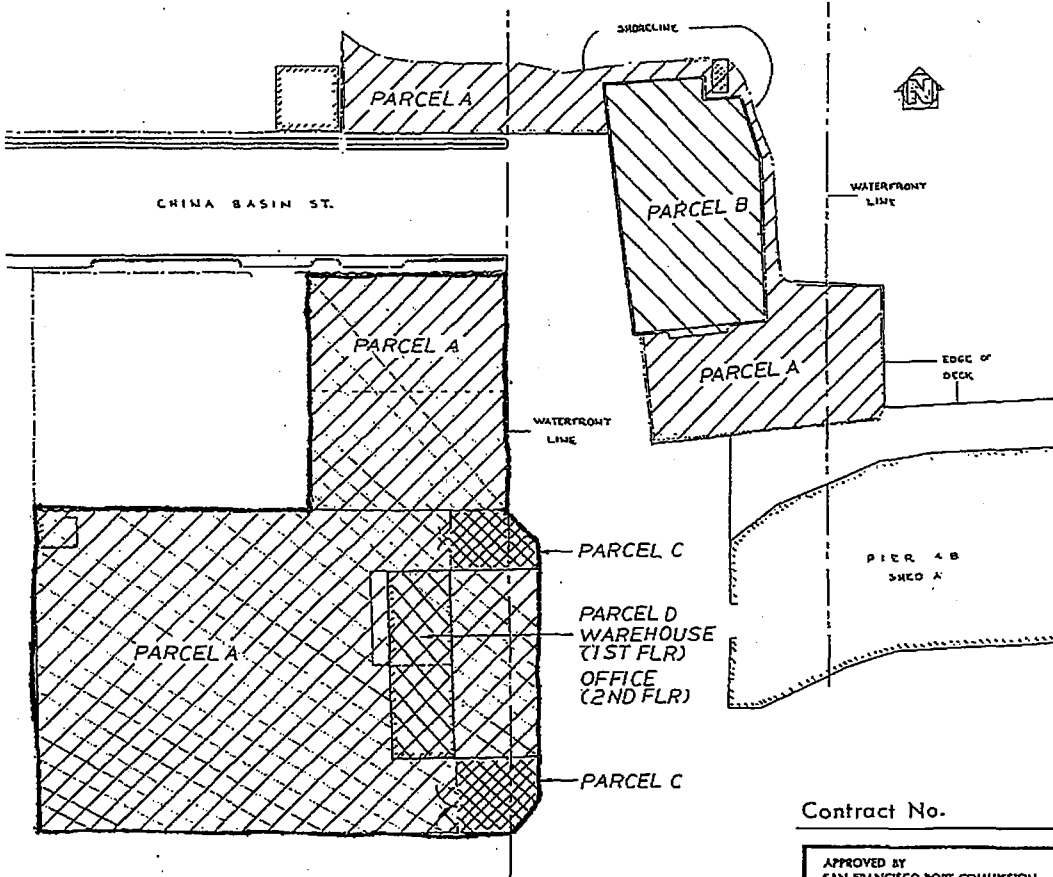

PARCEL A 91,844 SF
 PARCEL B 14,071 SF
 SUB-TOTAL 105,915 SF
 PARCEL C 4,105 SF
 PARCEL D
 WAREHOUSE 4,820 SF
 OFFICE 2,414 SF
 TOTAL 117,254 SF

Contract No.

APPROVED BY
 SAN FRANCISCO PORT COMMISSION
 DATE July 21, 1992
Chris Zinkler
 CHIEF ENGINEER

NO.	DATE	DESCRIPTION
REVISIONS		
PORT OF SAN FRANCISCO SAN FRANCISCO PORT COMMISSION DEPARTMENT OF ENGINEERING		
EXHIBIT A-1 H & H SHIP SERVICE CO. LEASE NO. L-11679		
DRAWN BY	E.C.C.	CHECKED BY
DESIGNED BY		DATE
SECTION HEAD		SCALE
DRAWING NO.		SHEET NO.
		OF SHEETS

200208 0-Wong

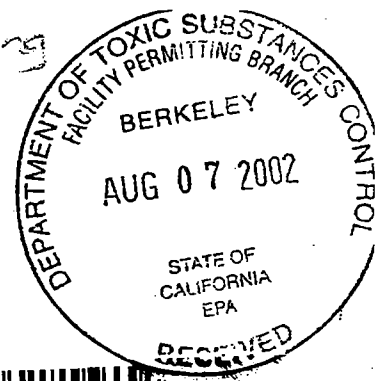

RECORDING REQUESTED BY:
The Port of San Francisco
Ferry Building
San Francisco, California 94111

WHEN RECORDED, MAIL TO

Department of Toxic Substances Control
700 Heinz Avenue, Suite 300
Berkeley, California 94710
Attention: Mohinder S. Sandhu, P.E., Chief
Standardized Permits and Corrective Action
Branch



San Francisco Assessor-Recorder
Doris M. Ward, Assessor-Recorder
DOC-2002-H209674-00

Acct 25-NO CHARGE DOCUMENT
Thursday, JUL 25, 2002 12:45:40
Ttl Pd \$0.00 Nbr-0001906468
REEL I187 IMAGE 0545
ojl/JL/1-14

SPACE ABOVE THIS LINE RESERVED FOR RECORDER'S USE

COVENANT TO RESTRICT USE OF PROPERTY

ENVIRONMENTAL RESTRICTION

(Re: H&H Site located at China Basin Channel and Terry Francois Blvd, City and County of San Francisco)

This Covenant and Agreement ("Covenant") is made by and between the City and County of San Francisco, a charter city and county in trust (the "Covenantor"), the current owner of certain property situated in the City and County of San Francisco, State of California, described in Exhibit "A", attached hereto and incorporated herein by this reference (the "Property"), and the Department of Toxic Substances Control (the "Department"). Pursuant to Civil Code section 1471(c) and the California Health and Safety Code, Section 25222.1, the Department has determined that this Covenant is reasonably necessary to protect present or future human health or safety or the environment as a result of the presence on the land of hazardous materials as defined in Health and Safety Code ("H&SC"), Section 25260. The Covenantor and the Department, collectively referred to as the "Parties", therefore intend that the use of the Property be restricted as set forth in this Covenant, in order to protect human health,

safety and the environment.

ARTICLE I
STATEMENT OF FACTS

1.01. The Property, totaling approximately 0.6 acres, is more particularly described in Exhibit "A" and depicted in Exhibit "A-1", attached hereto and incorporated herein by this reference. The Property is located in the area now generally bounded by Terry Francois Boulevard to the west, China Basin Channel to the north, and San Francisco Bay to the east, in the City and County of San Francisco, California.

1.02. The site was created by filling marshlands and shallow tidal flats bordering San Francisco Bay between 1877 and 1913. Sources of fill are unknown, but likely included construction/demolition debris and rubble, and rock and dirt cut from nearby hills. Historical uses of the Site include railroad tracks and related support structures and parking. From 1950 to 1996 H&H Ship Service occupied the area for wastewater treatment and transfer operations, including aboveground storage tanks for receiving, settling and treating wastewater containing petroleum.

In 1978 several of the wastes managed at the H&H Ship Service facility were determined to be hazardous wastes subject to federal and state hazardous waste management regulations. Since that time, the Department of Toxic Substances Control (or its predecessor in interest, the Department of Health Services) authorized H&H Ship Service's operations pursuant to an interim status document. Under this authorization the property was a hazardous waste facility (Facility), regulated by the Department, subject to the requirements of the California Hazardous Waste Control Law ("HWCL"), at Health and Safety Code ("H&S Code") section 25100 et seq., and the federal Resource Conservation and Recovery Act ("RCRA"), at 42 U.S.C. section 6901 et seq. Under Interim Status, the property was a portion of the Facility that was known as the Treatment/Transfer Area (TTA).

The Department is requiring this Covenant pursuant to the closure requirements of the HWCL, including H&S Code section 25246 and post-closure notices provisions of Title 22 California Code of Regulations [section 66265.119(b) for interim status hazardous waste facilities], as part of the facility closure. In 1994, the Department reviewed H&H's Closure Plan to ensure that the closure of the TTA met the requirements in Title 22, California Code of Regulations, Chapter 15, Article 7. The Department circulated the draft Closure Plan and Proposed Negative Declaration for public review and comment from August 11, 1994 to September 13, 1994. The Department approved the Closure Plan on January 13, 1995 and filed a Notice of Determination for the project with the

State Clearinghouse on February 15, 1995.

The Department reviewed the closure certification report titled, *RCRA Closure Certification Report, Former H&H Ship Service Facility, San Francisco, California*, (February 4, 1999), and subsequent submittals titled *Response to Comments, RCRA Closure Certification Report, Former H&H Ship Service Facility*, (November 2, 1999); *Results of Article 20 Sampling Program. Proposed China Basin Park Area* (July 2000); *Site Investigation and Surface Soil Sampling Results, Former H&H Ship Service Company – Treatment Transfer Area Parcel* (February 28, 2002); and *Addendum to the Article 20 Health Risk Assessment* (July 18, 2002). Upon filing of this deed restriction, the Department will approve the closure certification report.

Hazardous wastes, which are also hazardous materials as defined in Health and Safety Code sections 25117 and 25260, including petroleum hydrocarbons, polynuclear aromatic hydrocarbons, metals and arsenic, remain in the soil and groundwater at the Site at concentrations below those which would pose a significant human health risk under proposed reuse scenarios. Therefore a deed restriction to limit use of the property to those exposure scenarios evaluated and found to be below acceptable risk limits is required as part of the facility closure.

1.03. As detailed in the above-referenced reports, portions of the surface and subsurface soils on the Site contain hazardous wastes and hazardous materials, as defined in H&S Code section 25117 and 25260, including the following contaminants of concern: arsenic (up to 96 mg/kg) and benzo(a)pyrene (up to 11 mg/kg). Groundwater beneath the Property is found within 10 to 20 feet below ground surface. Dissolved arsenic was found in groundwater at up to 180 ug/l. The California drinking water standard for arsenic is 50 ug/l.

A review of the analytical results and the chemical distribution suggests that there are "hot spots". Hot spots are areas of affected soil or groundwater having concentrations higher than an empirically determined percentile of the distribution of concentrations in a particular population. 65 soil samples from 20 locations at various depths were collected within the TTA. Elevated concentrations of benzo(a)pyrene equivalent B(a)P EQ were measured in samples collected from two borings locations (EB-1, 19.8 milligrams per kilogram [mg/kg]) and (EB-20, 7.9 mg/kg). One surface soil sample (GMX-08) contained B(a)P EQ concentration of 1.5 mg/kg. All other concentrations of B(a)P EQ were less than 1 mg/kg. Elevated concentrations of arsenic and lead were observed in samples collected from borings EB-1 (3,000 mg/kg lead), EB-5 (96 mg/kg arsenic and 1,300 mg/kg lead), and EB-18 (2,400 mg/kg lead). Borings EB-1 and EB-5 are located in the eastern section of the TTA; GMX-08 is located near the northern perimeter; and borings EB-18 and EB-20 are located in the southwest section.

Based on these observations, borings EB-1, EB-5, GMX-08, EB-18, and EB-20 can be considered hot spots. However, each of borings is located under a concrete/asphalt

foundation or a compacted aggregate/crushed rock/roadbase material. The concrete/asphalt foundation or compacted aggregate/crushed rock/roadbase material serves as a physical barrier preventing direct contact with chemicals in soil; thus, there are no potential direct exposure pathways to chemicals at these hot spots by future receptors. If in the unlikely event that the concrete/asphalt foundation is removed, the excess cancer risk to a receptor from the hot spots would range from 9×10^{-5} to 3×10^{-6} .

Imported topsoil at least 18 inches thick followed by a layer of sod will be placed over the existing asphalt-concrete foundation. The concrete is present at one foot thick to at least 3 feet thick across approximately two-third of the TTA. The remaining one-third of the TTA is currently overlain with an aggregate/crushed rock/roadbase material. The concrete/asphalt foundation and compacted aggregate/crushed rock/roadbase layer precludes a complete exposure pathway. Additional of the 18 inches of topsoil and sod layer will eliminate potential direct exposures to soil in fill material within the TTA.

In order to ensure that no complete pathways are established, the Department will require that the existing concrete/asphalt foundation remain undisturbed so long as the intended use of the Property is to be a recreational park. Additionally, the Department will require that the site be covered (capped) with at least eighteen (18) inches of imported topsoil on top of an indicator lining material to denote the separation of the topsoil from native fill. Because the health risk assessment also did not evaluate an unrestricted land use scenario or potential impacts from use of groundwater, the Department concluded that use of the Property as a residence, hospital, school for persons under the age of 21, or day care center would entail an unacceptable use. The Department further concluded that the Property, subject to the restrictions of this Covenant, does not present an unacceptable threat to human safety or the environment.

ARTICLE II DEFINITIONS

2.01. Department. "Department" shall mean the California Department of Toxic Substances Control and shall include its successor agencies, if any.

2.02. Owner. "Owner" shall mean the Covenantor, its successors in interest, and their successors in interest, including heirs and assigns, who at any time hold title to all or any portion of the Property.

2.03. Occupant. "Occupant" shall mean Owners and any person or entity entitled by ownership, leasehold, or other legal relationship to the right to occupy any portion of the Property.

2.04. Cap. "Cap" shall mean eighteen (18) inches of imported topsoil on top of

an indicator lining material which is used to denote the separation of the imported topsoil from native fill.

2.05 Concrete/Asphalt Foundation. "Concrete/Asphalt Foundation" shall mean the existing concrete/asphalt surface which is overlain approximately two-third of the Property.

2.03. ARTICLE III GENERAL PROVISIONS

3.01. Restrictions to Run With the Land. This Covenant sets forth protective provisions, covenants, restrictions, and conditions (collectively referred to as "Restrictions"), upon and subject to which the Property and every portion thereof shall be improved, held, used, occupied, leased, sold, hypothecated, encumbered, and/or conveyed. Each and every one of the Restrictions: (a) shall run with the land pursuant to H&SC sections 25202.5, and 25202.6 and Civil Code section 1471; (b) shall inure to the benefit of and pass with each and every portion of the Property, (c) shall apply to and bind the respective successors in interest to the Property, (d) are for the benefit of, and shall be enforceable by the Department, and (e) are imposed upon the entire Property unless expressly stated as applicable only to a specific portion thereof.

3.02. Binding Upon Owners/Occupants. Pursuant to Health and Safety Code section 25202.5(b), this Covenant shall be binding upon all of the owners of the land, their heirs, successors, and assignees, and the agents, employees, and lessees of the owners, heirs, successors, and assignees. Pursuant to Civil Code section 1471(b), all successive owners of the Property are expressly bound hereby for the benefit of the covenantee(s) herein. "Owner" shall include "Covenantor".

3.03. Written Notice of Hazardous Substance Release. The Owner shall, prior to the sale, lease, or rental of the Property, give written notice that a release of hazardous substances has come to be located on or beneath the Property, pursuant to Health and Safety Code section 25359.7. Such written notice shall include a copy of this Covenant.

3.04. Incorporation into Deeds and Leases. The Restrictions set forth herein shall be incorporated by reference in each and all deeds and leases for any portion of the Property.

3.05. Conveyance of Property. Covenantor agrees that the Owner shall provide notice to the Department not later than thirty (30) days after any conveyance of any ownership interest in the Property (excluding mortgages, liens, and other non-possessory encumbrances). The Department shall not, by reason of this Covenant, have authority to approve, disapprove, or otherwise affect such proposed conveyance, except as otherwise provided by law, by administrative order, or specific provision of this Covenant.

ARTICLE IV
RESTRICTIONS

4.01. Prohibited Uses. The Property shall not be used for any of the following purposes:

- (a) A residence, including any mobile home or factory built housing, constructed or installed for use as residential human habitation;
- (b) A public or private school for persons under 21 years of age; or
- (c) A hospital for humans; or
- (c) A day care center for children.

4.02 Prohibited Activities. The following activities shall not be conducted at the Property:

- (a) No raising of food (e.g., cattle, food crops, cotton, etc.) shall be permitted on the property.
- (b) No groundwater shall be extracted on the Property for purposes other than site remediation or construction dewatering without prior written approval by the Department.

4.03 Non-Interference with the Cap. Covenantor agrees:

- (a) No activities which will disturb the Cap (e.g. excavation, grading, removal, trenching, filling, earth movement, or mining) shall be permitted on the Property without prior review and approval by the Department.
- (b) All uses and development of the Property shall preserve the integrity of the Cap.
- (c) Any proposed alteration of the Cap shall require written approval by the Department.
- (d) Covenantor shall notify the Department of each of the following: (i) The type, cause, location and date of any disturbance to the Cap which could affect the ability of the Cap to contain subsurface hazardous materials in the Property, and (ii) the type and date of repair of such disturbance. Notification to the Department shall be made as provided below within ten (10) working days of both the discovery of any such disturbance(s) and the completion of any repairs. Timely and accurate notification by any Owner or Occupant shall satisfy this requirement on behalf of all other

Owners and Occupants.

4.04. Management of Native Fill and Concrete/Asphalt Foundation Material

- (a) All uses and development of the Property shall preserve the integrity of the existing Concrete/Asphalt Foundation.
- (b) No activities (e.g., excavation, grading, removal, trenching, filling, earth movement or mining) which will disturb the native fill and/or the Concrete/Asphalt Foundation material underlying the Cap as indicated in Exhibit B shall be permitted on the Property without a Department-approved Soil Management Plan and Health and Safety Plan.
- (c) Native fill and/or Concrete/Asphalt Foundation material shall not be managed or handled such that it may migrate into the bay.
- (d) Any native fill and/or Concrete/Asphalt Foundation material brought to the surface by grading, excavation, trenching or backfilling shall be managed in accordance with the applicable state and federal laws and their implementing regulations.
- (e) The Owner shall provide the Department written notice at least fourteen (14) days prior to any building, filling, grading, mining or excavating at the Property.
- (f) If more than 50 cubic yards of any native fill will be disturbed, including excavation and grading, then the soil shall be evaluated for potential human health risks in compliance with Article 20 of the SF Municipal Code ("the Maher Ordinance"), and managed accordingly.
- (g) Covenantor shall notify the Department of each of the following: (i) The type, cause, location and date of any disturbance to the native fill and/or Concrete/Asphalt Foundation which could affect the ability of the Concrete/Asphalt Foundation to contain subsurface hazardous materials in the Property, and (ii) the type and date of repair of such disturbance. Notification to the Department shall be made as provided below within ten (10) working days of both the discovery of any such disturbance(s) and the completion of any repairs. Timely and accurate notification by any Owner or Occupant shall satisfy this requirement on behalf of all other Owners and Occupants.

4.05. Access for Department. Covenantor agrees that the Department shall

have reasonable right of entry and access to the Property for inspection, monitoring, and other activities consistent with the purposes of this Covenant as deemed necessary by the Department in order to protect the public health and safety.

ARTICLE V
ENFORCEMENT

5.01. Enforcement. Failure of the Covenantor and/or Owner to comply with any of the Restrictions specifically applicable to it shall be grounds for the Department, by reason of this Covenant, to require that the Covenantor and/or Owner modify or remove any improvements ("Improvements" herein shall mean all buildings, roads, driveways, and paved parking areas, constructed or placed upon any portion of the Property constructed in violation of the Restrictions.) Violation of this Covenant shall be grounds for the Department to file civil and/or criminal actions against the Covenantor and/or Owner as provided by law.

ARTICLE VI
VARIANCE, TERMINATION, AND TERM

6.01. Variance. Any Owner or, with the Owner's written consent, any Occupant of the Property or any portion thereof may apply to the Department for a written variance from the provisions of this Covenant. Such application shall be made in accordance with H&S Code section 25202.6.

6.02. Termination. Any Owner, and/or, with the Owner's written consent, any Occupant of the Property, or any portion thereof, may apply to the Department for a termination of the Restrictions or other terms of this Covenant as they apply to all or any portion of the Property. Such application shall be made in accordance with H&S Code section 25202.6.

6.03. Term. Unless ended in accordance with the Termination Paragraph above, by law, or by the Department in the exercise of its discretion, this Covenant shall continue in effect in perpetuity.

ARTICLE VII
MISCELLANEOUS

7.01. No Dedication Intended. Nothing set forth in this Covenant shall be construed to be a gift or dedication, or offer of a gift or dedication, of the Property, or any portion thereof to the general public or anyone else for any purpose whatsoever.

7.02. Department References. All references to the Department include successor agencies/departments or other successor entity.

7.03. Recordation. The Covenantor shall record this Covenant, with all referenced Exhibits, in the County of San Francisco within ten (10) days of the Covenantor's receipt of a fully executed original.

7.04. Notices. Whenever any person gives or serves any notice ("Notice" as used herein includes any demand or other communication with respect to this Covenant), each such Notice shall be in writing and shall be deemed effective: (1) when delivered, if personally delivered to the person being served or to an officer of a corporate party being served, or (2) three (3) business days after deposit in the mail, if mailed by United States mail, postage paid, certified, return receipt requested:

To Owner:

Carol Bach
Assist. Deputy Director, Environmental Health and Safety
Port of San Francisco
Pier 1
San Francisco, CA 94111

With a copy to:

Noreen Ambrose
Port General Counsel
Port of San Francisco
Pier 1
San Francisco, CA 94111.

To Department:

California Environmental Protection Agency
Department of Toxic Substances Control
700 Heinz Avenue, Suite 300
Berkeley, CA 94710-2737
Attention: Chief, Standardized Permits and Corrective Action
Branch

Any party may change its address or the individual to whose attention a notice is to be sent by giving written notice in compliance with this paragraph.

7.05. Partial Invalidity. If any portion of the Restrictions or other term set forth herein is determined by a court of competent jurisdiction to be invalid for any reason, the surviving portions of this Covenant shall remain in full force and effect as if such portion found invalid had not been included herein.

H209674

IN WITNESS WHEREOF, the Parties execute this Covenant.

"Covenantor"

Date: 7/24/02

By: //original signed by//
DOUGLAS F. WONG
Its: Executive Director

"Department"

Date: 7/24/02

By: //original signed by//
Mohinder S. Sandhu, P.E.
Its: Chief, Standardized Permits and Corrective Action
Branch

CALIFORNIA ALL-PURPOSE ACKNOWLEDGMENT

State of California

County of San Francisco } ss.

On July 24, 2002 before me, Virna C. Wu "Notary Public"
Date Name and Title of Officer (e.g., "Jane Doe, Notary Public")

personally appeared Mohinder Singh Sandhu
Name(s) of Signer(s)

- personally known to me.
- ~~proved to me on the basis of satisfactory evidence~~



to be the person(s) whose name(s) is/are subscribed to the within instrument and acknowledged to me that he/she/they executed the same in his/her/their authorized capacity(ies), and that by his/her/their signature(s) on the instrument, or the entity upon behalf of which the person(s) acted, executed the instrument.

WITNESS my hand and official seal.

Place Notary Seal Above

//original signed by//
Signature of Notary Public

OPTIONAL

Though the information below is not required by law, it may prove valuable to persons relying on the document and could prevent fraudulent removal and reattachment of this form to another document.

Description of Attached Document

Title or Type of Document: Covenant to Restrict Use of Property

Document Date: None Number of Pages: 10 Pages + Exhibits A & B

Signer(s) Other Than Named Above: None

Capacity(ies) Claimed by Signer

Signer's Name: Mohinder Singh Sandhu

- Individual
- Corporate Officer — Title(s): _____
- Partner — Limited General
- Attorney in Fact
- Trustee
- Guardian or Conservator
- Other: Port Executive Director

Signer Is Representing: Port of San Francisco

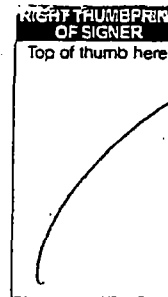

CALIFORNIA ALL-PURPOSE ACKNOWLEDGMENT

State of California }
County of San Francisco } ss.

On July 24, 2002 before me, Virna C. Wu "Notary Public"
Date Name and Title of Officer (e.g., "Jane Doe, Notary Public")

personally appeared Mohinder Singh Sandhu
Name(s) of Signer(s)

- personally known to me
- proved to me on the basis of satisfactory evidence

to be the person(s) whose name(s) is/are subscribed to the within instrument and acknowledged to me that he/she/they executed the same in his/her/their authorized capacity(ies), and that by his/her/their signature(s) on the instrument the person(s), or the entity upon behalf of which the person(s) acted, executed the instrument.

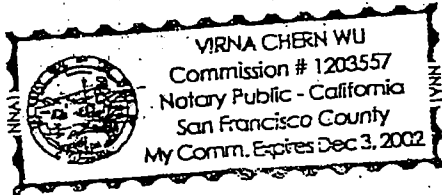

WITNESS my hand and official seal.

//original signed by//
Signature of Notary Public

Place Notary Seal Above

OPTIONAL

Though the information below is not required by law, it may prove valuable to persons relying on the document and could prevent fraudulent removal and reattachment of this form to another document.

Description of Attached Document

Title or Type of Document: Covenant to Restrict Use of Property

Document Date: None Environmental Restriction Number of Pages: 10 Pages + Exhibits A & B

Signer(s) Other Than Named Above: None

Capacity(ies) Claimed by Signer

Signer's Name: Mohinder Singh Sandhu

- Individual
- Corporate Officer — Title(s): _____
- Partner — Limited General
- Attorney in Fact
- Trustee
- Guardian or Conservator
- Other: Chief, Standardized Permits & Corrective

Signer Is Representing: Department of Toxic Substances
Action Branch
Control

RIGHT THUMBPRINT OF SIGNER

Top of thumb here

EXHIBIT A

H&H Parcel – Tank Treatment Area

All that certain real property of the San Francisco Port Commission, City and County of San Francisco, State of California, situate at the northeast corner of Terry A. Francois Boulevard (formerly China Basin Street), more particularly described as follows:

Commencing at the point of intersection of the northwesterly line of Townsend Street with the southwesterly line of Delancey Street (formerly First Street), said point being Inner 14 of the Inner Waterfront Line as described in records on file in the office of Engineering of said San Francisco Port Commission; Thence along said Inner Waterfront Line, S 03°02'27" E a distance of 2132.11 feet; Thence N 86°51'14" E a distance of 65.28 feet, to the True Point Of Beginning; Thence S 10°21'36" E a distance of 127.93 feet; Thence N 80°50'39" E a distance of 4.70 feet; Thence S 09°13'14" E a distance of 68.59 feet; Thence N 81°09'11" E a distance of 146.17 feet; Thence N 03°21'24" W a distance of 85.74 feet; Thence S 88°44'14" W a distance of 54.91 feet; Thence N 66°55'27" W a distance of 9.19 feet; Thence N 07°12'31" W a distance of 68.86 feet; Thence N 21°58'29" W a distance of 44.82 feet; Thence S 83°22'07" W a distance of 28.09 feet; Thence N 05°44'30" W a distance of 14.69 feet; Thence S 81°59'17" W a distance of 65.99 feet; Thence S 10°21'36" E a distance of 30.22 feet to the True Point Of Beginning; Containing 26,592 square feet (0.61 acres), more or less.

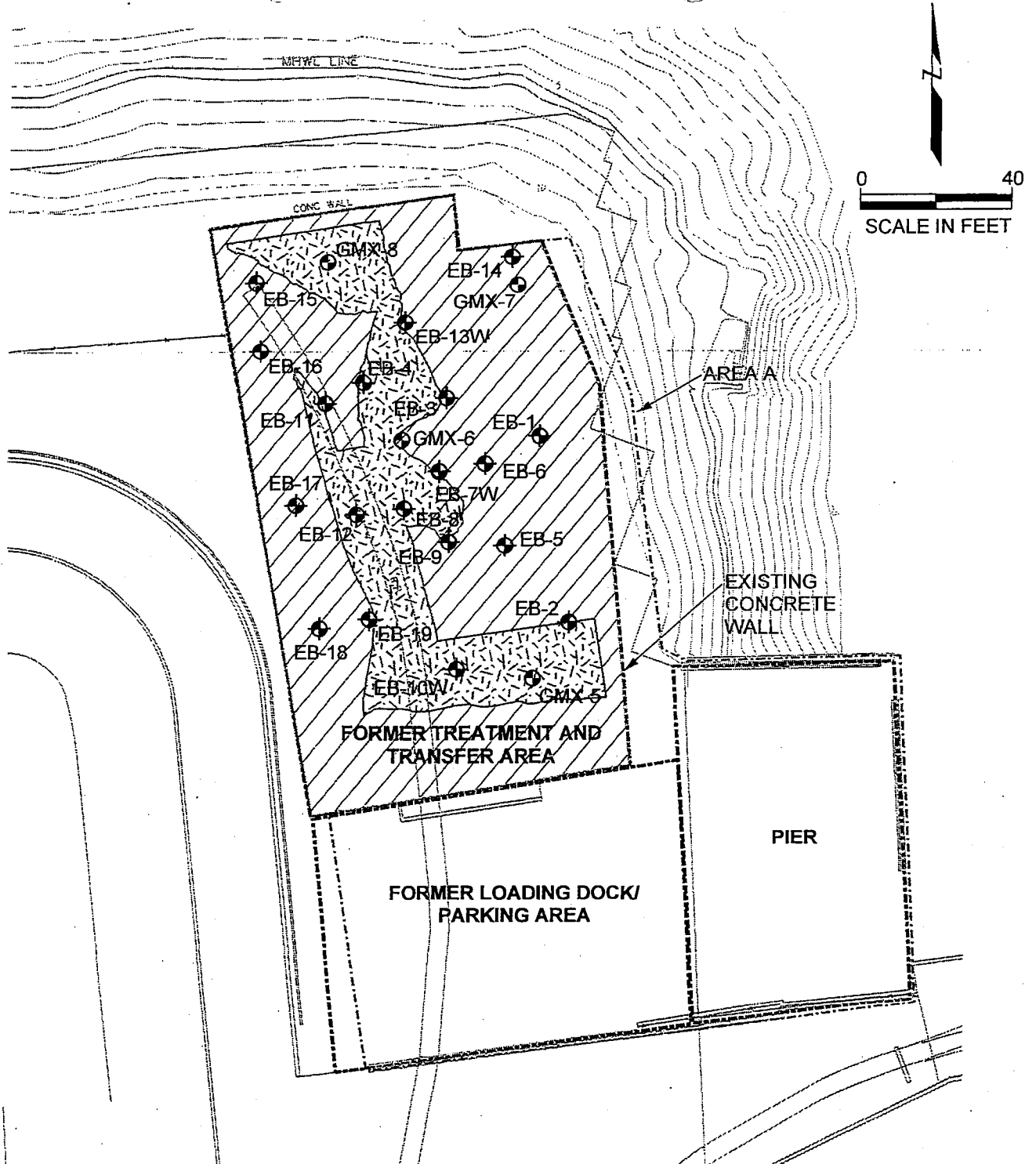

EXPLANATION

- ⊕ Soil samples collected at multiple depths by J. Yang and Assoc. March 15, 1995
- ⊙ Surface soil samples collected by Geomatrix, November 16, 2001

-  Area of aggregate/crushed rock/road base material
-  Concrete/asphalt foundation

EXHIBIT B

APPENDIX C
Soil Management Plan
June 1999

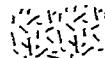
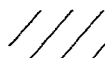

SOIL MANAGEMENT PLAN

Imperial Weitz Parking Lots for the Giants Pacific Bell Ball Park Area E - Port of San Francisco Property

San Francisco, California

Prepared for:

Imperial Weitz, LLC
800 Second Avenue, Suite 300
Des Moines, Iowa 50309

Prepared by:

Geomatrix Consultants, Inc.
2101 Webster Street, 12th Floor
Oakland, California 94612
(510) 663-4100

June 1999

Project No. 4952

Geomatrix Consultants

TABLE OF CONTENTS

	Page
1.0 INTRODUCTION.....	1
2.0 BACKGROUND.....	1
2.1 SITE SETTING AND HISTORICAL USAGE.....	1
2.2 SITE INVESTIGATIONS.....	2
2.2.1 Previous Site Investigations	2
2.2.2 Recent Site Investigation.....	2
2.3 PROPOSED DEVELOPMENT.....	3
2.4 RISK ASSESSMENT.....	4
3.0 OBJECTIVES.....	4
4.0 PROPOSED SOIL MANAGEMENT PROCEDURES.....	5
4.1 SOIL MANAGEMENT PROCEDURES FOR SITE CONSTRUCTION.....	5
4.1.1 Dust Control	5
4.1.2 Erosion Control	5
4.1.3 Soil Stockpile Management.....	6
4.1.4 Soil Disposal.....	6
4.1.5 Site Access Control	6
4.2 SOIL MANAGEMENT FOLLOWING SITE DEVELOPMENT	6
5.0 MAINTENANCE OF SITE COVER.....	7
6.0 CONTINGENCY PLAN.....	7
7.0 HEALTH AND SAFETY GUIDELINES.....	7
8.0 FACILITY MAP	8
9.0 REFERENCES.....	9

TABLES

Table 1	Summary of Analytical Results - Metals Detected in Soil Samples
Table 2	Summary of Analytical Results - Volatile Organic Compounds Detected in Soil Samples
Table 3	Summary of Analytical Results - Polynuclear Aromatic Compounds Detected in Soil Samples
Table 4	Summary of Analytical Results - Other Maher Parameters
Table 5	Summary of Analytical Results - Metals Detected in Grab Groundwater Samples
Table 6	Summary of Health Risk Assessment Results

TABLE OF CONTENTS
(Continued)

FIGURES

- Figure 1 Site Location Map
Figure 2 Site Plan Showing Sampling Locations

APPENDIXES

- Appendix A Data Summaries from Previous Investigations
Appendix B Site Maps Illustrating Alternative Storm Drainage Systems



SOIL MANAGEMENT PLAN
Imperial Weitz Parking Lots for the
Giants Pacific Bell Ball Park
Area E - Port of San Francisco Property
San Francisco, California

1.0 INTRODUCTION

Geomatrix Consultants, Inc. (Geomatrix) has prepared this Soil Management Plan (SMP) on behalf of Imperial Weitz, LLC for the proposed 14-acre parking lot for the Giants' Pacific Bell Ball Park. The proposed parking lot site is located south of China Basin Channel and east of Third Street in San Francisco, California (the site; Figure 1). The site is part of a total of approximately 36 acres of parking to be developed by Imperial Weitz south of China Basin Channel and has been referred to as Area E in previous environmental documents prepared by Geomatrix on behalf of Imperial Weitz.

2.0 BACKGROUND

Imperial Weitz is proposing to construct a paved parking lot on the site. A site history review, environmental investigation and risk evaluation were performed to meet Article 20 requirements and assess potential risks to construction worker and site visitor health associated with soil and groundwater quality at the site. The following summarizes the results of the site history review, environmental investigations, and risk assessment, and describes the proposed parking lot development.

2.1 SITE SETTING AND HISTORICAL USAGE

The approximately 19 acre site is currently owned by the Port of San Francisco (the Port). The subject area was originally marshlands and shallow tidal flats bordering San Francisco Bay. It was filled between 1877 and 1913; the source of the fill is unknown but likely included construction debris and rubble from the 1906 earthquake and cut material from nearby hills and construction areas.

Historical site uses include: railroad trackage and support structures for rail-related activities, parking and shipping, and truck maintenance. H&H Shipping Service Company, Inc. (H&H) occupied the northeastern corner of the site from 1950 to 1996. H&H used the area for vehicle parking and offices, and maintained a tank cleaning area and drum storage unit. No known underground storage tanks (USTs) have been identified on the site. Recently, the site has been

leased by multiple tenants. Tenant uses consist of a recycling center, an automobile sales center, the Mission Rock Recovery Center, a moving company, maritime offices, and automobile storage.

2.2 SITE INVESTIGATIONS

2.2.1 Previous Site Investigations

Burlington Northern Santa Fe Railway Company ("the Railroad") conducted Phase I and Phase II Environmental Assessments of property formerly operated by the Railroad located east of Third Street, between Sixteenth Street and China Basin Channel; this property included the western half of the site. The scope of the Railroad's investigations included one soil boring in the southern portion of the site. Soil samples were collected at depths of 0.5, 5, and 8 feet bgs and analyzed for total petroleum hydrocarbons as gasoline (TPHg), TPH as motor oil (TPHmo), lead, nickel, arsenic, chromium, cadmium, and zinc. Results of chemical analyses on these soil samples indicated that several metals were present at concentrations exceeding typical regional background concentrations (Geomatrix, March 1999).

In addition, HLA has performed an investigation of the former H&H Shipping parcel located in the northeast corner of the site (HLA; 1999). Seventeen soil samples were collected and analyzed for metals, TPH as diesel (TPHd), TPHg, oil and grease, volatile organic compounds (VOCs), polychlorinated biphenyls (PCBs), and polynuclear aromatic hydrocarbons (PNAs). Five groundwater samples were collected and one or more samples were analyzed for metals, TPHd, TPHg, benzene, toluene, ethylbenzene, xylenes [BTEX], PCBs, and PNAs. Several soil samples contained PNAs and metals; very low concentrations of some aromatic hydrocarbons and PCBs were detected in a few soil samples. The groundwater samples contained low to trace concentrations of several metals. Filtered groundwater samples did not contain PNAs; however, unfiltered samples contained low concentrations of several PNA compounds. PCBs and BTEX were not detected in the groundwater samples. Summary tables for the soil and groundwater analysis results of the H&H investigation are contained in Appendix A.

2.2.2 Recent Site Investigation

In April 1999, Geomatrix installed 8 soil borings and collected 16 soil samples (two soil samples per boring) and 2 groundwater samples (from 2 of the 8 locations) for chemical analysis. Sampling locations are illustrated on Figure 2. Primary chemicals detected in soil were PNAs and some metals (i.e., antimony, arsenic, copper, lead, nickel, and mercury). Soil sample results from the recent investigation are summarized in Tables 1 through 5. Several

metals were detected in groundwater; however, chemical concentrations were generally low to non-detect (Table 6). PNAs were not detected in the groundwater samples.

2.3 PROPOSED DEVELOPMENT

The proposed development for the subject area is asphalt paved parking. Two alternatives for storm drainage are being considered, as described below. Figures illustrating the two alternatives for the storm drainage system are contained in Appendix B.

Alternative 1

This alternative for the drainage system consists of a series of storm drainage lines and catch basins to collect and transport storm water from the parking lot site to the main City box culvert located on Channel Street, west of Fourth Street. During a 5 year storm event, the City system could reach capacity and overflows would result. Overflows from the parking lot site would be diverted to a small treatment plant to be located east of Fourth Street, near China Basin Channel. Under this alternative, Area E will be entirely paved with asphalt and surrounded by a 3- to 4-foot fence.

The catch basins will be installed in excavations with aerial dimensions of approximately 4 feet by 4 feet and extending to depths of 4 to 6 feet. Trenches will be excavated to install the piping; the trenches are anticipated to be approximately 2 to 3-foot wide and will extend between 4 to 6 feet below grade. Estimated maximum excavation depth for the piping system is 6 feet bgs. The parking area will be graded and bermed to enhance flow to each of the catch basins, and paved with asphaltic concrete.

Alternative 2

This alternative includes perimeter grassy drainage swales to collect and drain storm water overflows.

The parking area will contain a storm drain system to collect surface water runoff. The storm drain system will consist of a network of catch basins and drainage swales to collect storm water on the parking lot. The storm water will be conveyed through a series of pipes and the drainage swales to one point of discharge. The discharge pipe will collect into one main and flow into the City box sewer in Channel Street near Fourth Street.

The catch basins will be installed in excavations with aerial dimensions of approximately 4 feet by 4 feet and extending to depths of 4 to 6 feet. Trenches will be excavated to install the

pipng; the trenches are anticipated to be approximately 2 to 3 feet wide and will extend between 4 to 6 feet below grade. Estimated maximum excavation depth for the piping system is 6 feet bgs. The swales will be approximately 32 feet in width and 2 to 3 feet in depth. The swales will be covered with a geotextile fabric and grass. The parking area will be graded and bermed to enhance flow to each of the catch basins, and paved with asphaltic concrete.

2.4 RISK ASSESSMENT

A health risk assessment (HRA) was conducted to evaluate the potential human health risks associated with the presence of chemicals in soil and groundwater assuming future use of the site as a parking lot with grassy swales (Geomatrix, May 1999). Potential noncarcinogenic hazard indexes and theoretical lifetime excess cancer risks were estimated for future on-site construction workers and future on-site visitors assuming conservative estimates of human exposure. Future on-site construction workers may be exposed to chemicals in soil across the site to the depth required for installation of the storm drain system or in groundwater if encountered in excavation areas. Following construction, potential exposure to future on-site visitors would be limited to exposed soil in the grass-covered swale areas.

The results of the HRA indicate that the presence of chemicals in soil and groundwater at the site should not pose an unacceptable noncarcinogenic or carcinogenic risk to future on-site construction workers and visitors. A summary table for the HRA results is provided as Table 7. Based on these results, it was also concluded that potential risks to nearby residents during construction and future on-site maintenance workers and trespassers after construction would also not be of concern.

3.0 OBJECTIVES

As described above, the results of the HRA indicate that chemicals in site soil do not present an unacceptable human health risk. However, dust from a construction site can present a nuisance if not controlled. Likewise, erosion of on-site soil during construction activities can increase the turbidity of surface water run-off.

Therefore, the objectives of the SMP are to:

- provide guidelines for soil handling, stockpiling, dust and erosion minimization and, if needed, soil disposal during site construction activities for the proposed parking lot; and

- describe procedures for soil management following site construction for the duration of the use of the Site as a parking lot.

4.0 PROPOSED SOIL MANAGEMENT PROCEDURES

The following two sections describe the soil management procedures that will be implemented during and following site construction.

4.1 SOIL MANAGEMENT PROCEDURES FOR SITE CONSTRUCTION

The following procedures will be implemented during site construction activities to minimize dust and control erosion.

4.1.1 Dust Control

The dust control measures to be implemented at the site correspond to the PM₁₀ control measures recommended by the Bay Area Air Quality Management District (BAAQMD) in their California Environmental Quality Act Guidelines. These measures consist of:

- Water all active construction areas at least twice daily or as necessary to prevent visible dust plumes from migrating outside of the site limits.
- Mist or spray water while loading transportation vehicles.
- Minimize drop heights while loading transportation vehicles.
- Use tarpaulins or other effective covers for trucks carrying soils that travel on public streets.
- Pave, apply water 3 times daily, or apply non-toxic soil stabilizers on all unpaved access roads, parking areas, and staging areas.
- Sweep all paved access routes parking areas and staging areas daily, if visibly soiled.
- Sweep street daily if visible soil material is carried onto public streets from the site.

4.1.2 Erosion Control

A Stormwater Pollution Prevention Plan (SWPPP) will be developed by the site contractor prior to initiation of Site work that details procedures for minimizing erosion. The SWPPP will include elements such as silt traps and hay bales to minimize surface water runoff from the Site into storm drains or the San Francisco Bay, berms to control Site runoff, and covering soil stockpiles during the rainy season (November through March) to minimize sediment runoff.

4.1.3 Soil Stockpile Management

Temporary stockpiling of excavated soil may be necessary throughout site construction. Soil stockpiled at the Site will be lightly sprayed with water as needed to minimize dust. To the extent practical, the soil stockpiles will be covered with plastic sheeting or other similar material at times when not in active use. When a soil stockpile is uncovered during the rainy season, it will be surrounded by hay bales and/or silt traps to minimize sediment runoff.

4.1.4 Soil Disposal

Site development has been designed to minimize the generation of excess soil; therefore, soil requiring off-site disposal is not anticipated. Although not anticipated at this time, if excess soil is generated from the site, the excess soil will be profiled to determine appropriate disposal options. Handling and disposal of the soil will be conducted in accordance with all applicable state and federal laws.

Based on chemical analysis results of soil samples collected from the site, total metal and organic concentrations are less than the Total Threshold Limit Concentrations (TTLCs) for designation as California Hazardous Waste. However, additional solubility testing of some of the metals (e.g., lead) would likely be required by disposal facilities to better assess the waste profile for the soil.

4.1.5 Site Access Control

The construction site will be fenced to control pedestrian or vehicular entry, except at controlled points (i.e., gates). Gates will be closed and locked during non-construction hours. "No-trespassing" signs will be posted every 500 feet along the fencing.

4.2 SOIL MANAGEMENT FOLLOWING SITE DEVELOPMENT

Following site development, the soil will be covered by asphalt pavement or grass (in the swale areas) and it is unlikely that the soil will be accessed, with the exception of future maintenance work on subsurface utilities. The HRA assessed possible health risks to future maintenance workers at the parking lot and concluded that chemicals in soil at the site should not pose an unacceptable carcinogenic or noncarcinogenic risk (Geomatrix, May 1999). Soil management procedures during future site maintenance work requiring soil excavation will be as described in Section 4.1 of this SMP; if waste soil is generated, the soil will be disposed in accordance with the procedures described in Section 4.1.4.

5.0 MAINTENANCE OF SITE COVER

Procedures in this section are applicable only if Alternative 2 is selected for the storm drainage system.

Although the HRA concluded that soil in the grass-covered swale area would not present an unacceptable risk to human health for parking lot visitors or trespassers, it is prudent that the grass-covered swale areas be well maintained. Therefore, the swale areas will be inspected monthly during the baseball season, and quarterly during the off-season to visually observe the condition of the grass cover. Large areas of exposed soil (e.g., areas larger than several feet in diameter) should be reseeded as quickly as practical. A log of the parking area inspections ("Inspection Log") will be maintained at the site and will include written comments on the condition of the grass cover, areas requiring repairs, and repair dates.

Annual inspections of the paved parking areas will be performed to observe whether breaches in the pavement that may allow prolonged access to site soil are visible. If observed, the breach would be repaired such that the soil cover is maintained. Results of the annual inspections of the paved parking areas will be documented in the Inspection Log, described above.

6.0 CONTINGENCY PLAN

A Contingency Plan for this site is not warranted. The purpose of a Contingency Plan is to present response actions to an emergency situation. The results of the HRA indicate that exposure to site soil or groundwater while breaches in the pavement or grassy areas are being repaired would not present a situation requiring an emergency response.

7.0 HEALTH AND SAFETY GUIDELINES

A health and safety plan for site construction will be developed by the site contractor before initiation of the development activities. The results of the HRA indicate that the presence of chemicals in soil and groundwater at the site should not pose an unacceptable health risk to future construction workers or nearby receptors during construction or future maintenance workers, visitors or trespassers after construction. Therefore, a health and safety plan for known chemical hazards at the Site is not warranted, and the health and safety plan will focus on physical hazards. Additionally, contingency actions for encountering unanticipated buried hazards (e.g., drums, or other containers) will also be included in the health and safety plan.



8.0 FACILITY MAP

The final construction plan for the Site development is not complete. A copy of this plan will be forwarded to the SFDPH as an addendum to this SMP once it has been finalized.



9.0 REFERENCES

Geomatrix Consultants, Inc., 1999, Site Use History and Article 20 Sampling Program, March.

Harding Lawson Associates, 1999, RCRA Closure Certification Report, Former H&H Ship Service Facility, San Francisco, California, February 4.

TABLE 1
SUMMARY OF ANALYTICAL RESULTS
METALS DETECTED IN SOIL SAMPLES¹

Proposed Imperial Parking Area
Area E - Port of San Francisco Property
South of China Basin Channel, San Francisco, California

Concentrations are reported in milligrams per kilogram (mg/kg)

Sample I.D.	Sample Interval (feet bgs)	Antimony	Arsenic	Barium	Beryllium	Cadmium	Total Chromium	Cobalt	Copper	Lead	Mercury	Molybdenum	Nickel	Selenium	Silver	Thallium	Vanadium	Zinc
GMX-1-1.0	0.5 - 1.0	<5.0	<0.35	27	<5.0	<5.0	120	16	9.6	8.7	<0.1	<5.0	220	<5.0	<5.0	<5.0	36	37
GMX-1-4.5	4.5 - 5.0	<5.0	2.5	35	<5.0	<5.0	200	24	12	13	<0.1	<5.0	370	<5.0	<5.0	<5.0	20	32
GMX-2-1.0	0.5 - 1.0	<5.0	<0.35	170	<5.0	<5.0	62	15	50	220	0.13	<5.0	71	<5.0	<5.0	<5.0	49	150
GMX-2-4.5	4.5 - 5.0	<5.0	<0.35	160	<5.0	<5.0	91	17	31	54	<0.1	18	110	<5.0	<5.0	<5.0	40	83
GMX-3-1.0	0.5 - 1.0	33	64	84	<5.0	<5.0	35	12	93	250	0.28	<5.0	140	<5.0	<5.0	<5.0	20	250
GMX-3-4.5	4.5 - 5.0	15	7.7	76	<5.0	<5.0	110	14	44	98	0.23	<5.0	240	<5.0	<5.0	<5.0	24	130
GMX-4-1.0	0.5 - 1.0	<5.0	1.8	170	<5.0	<5.0	42	16	40	110	0.16	<5.0	100	<5.0	<5.0	<5.0	31	94
GMX-4-4.5	4.5 - 5.0	<5.0	<0.35	100	<5.0	<5.0	36	8.7	26	53	<0.1	<5.0	40	<5.0	<5.0	<5.0	27	60
GMX-5-1.0	0.5 - 1.0	<5.0	0.47	26	<5.0	<5.0	21	<5.0	7.1	42	<0.1	<5.0	20	<5.0	<5.0	<5.0	17	69
GMX-5-7.0	4.5 - 5.0	<5.0	2.5	47	<5.0	<5.0	11	<5.0	13	60	0.57	<5.0	12	<5.0	<5.0	<5.0	12	35
GMX-6-1.0	0.5 - 1.0	<5.0	<0.35	360	<5.0	<5.0	17	12	66	17	<0.1	<5.0	21	<5.0	<5.0	<5.0	28	40
GMX-6-4.5	4.5 - 5.0	<5.0	<0.35	210	<5.0	<5.0	43	14	46	62	0.18	<5.0	59	<5.0	<5.0	<5.0	29	55
GMX-7-1.0	0.5 - 1.0	<5.0	10	160	<5.0	<5.0	21	5.3	93	290	5.7	<5.0	28	<5.0	<5.0	<5.0	17	320
GMX-7-5.0	4.5 - 5.0	<5.0	<0.35	180	<5.0	<5.0	87	21	35	750	<0.1	<5.0	250	<5.0	<5.0	<5.0	29	160
GMX-8-1.0	0.5 - 1.0	<5.0	<0.35	680	<5.0	<5.0	21	32	130	18	<0.1	<5.0	34	<5.0	<5.0	<5.0	40	49
GMX-8-4.5	4.5 - 5.0	<5.0	5	100	<5.0	<5.0	6.8	<5.0	21	61	<0.1	<5.0	9.1	<5.0	<5.0	<5.0	12	41
Background ²		5.5	19.1	323	1	2.7	99	22	69	16	0.4	7.4	120	5.6	1.8	27	74	106
95% UTL		25.7	45.7	572.3	5.0	5.0	190.0	32.8	133.1	602.0	4.0	14.0	379.8	5.0	5.0	5.0	53.7	311.7
95% UTL > Background?		Yes	Yes	Yes	NA	NA	Yes	Yes	Yes	Yes	Yes	Yes	Yes	NA	NA	NA	No	Yes

Note:

¹ Soil samples collected by Geomatrix Consultants, Inc. and analyzed by Entech Analytical Laboratories of Sunnyvale, California, for Title 22 metals using EPA Methods 6000/7000 Series.

² Background = Lawrence Berkeley National Laboratory, 1995.

Abbreviations:

feet bgs = feet below ground surface.

< = analyte not detected at or above method detection limit shown.

NA = not applicable; sample results below detection limit reported by the analytical laboratory.

95% UTL = 95 percent upper tolerance limit.



TABLE 2
SUMMARY OF ANALYTICAL RESULTS
VOLATILE ORGANIC COMPOUNDS DETECTED IN SOIL SAMPLES¹
Proposed Imperial Parking Area
Area E - Port of San Francisco Property
South of China Basin Channel, San Francisco, California
Concentrations are reported in milligrams per kilogram (mg/kg)

Sample I.D.	Sample Interval (feet bgs)	Toluene	Ethyl-benzene	Xylenes	1,2,4-Trimethyl-benzene
GMX-1-1.0	0.5 - 1.0	0.030	<0.005	0.029	0.010
GMX-1-4.5	4.5 - 5.0	0.008	<0.005	<0.005	<0.005
GMX-2-1.0	0.5 - 1.0	0.013	<0.005	0.009	0.005
GMX-2-4.5	4.5 - 5.0	0.007	<0.005	<0.005	<0.005
GMX-3-1.0	0.5 - 1.0	0.014	<0.005	0.006	<0.005
GMX-3-4.5	4.5 - 5.0	0.023	<0.005	0.018	0.014
GMX-4-1.0	0.5 - 1.0	0.020	<0.005	0.030	<0.005
GMX-4-4.5	4.5 - 5.0	<0.005	<0.005	<0.005	<0.005
GMX-5-1.0	0.5 - 1.0	0.027	<0.005	0.014	0.008
GMX-5-7.0	4.5 - 5.0	<0.005	<0.005	<0.005	<0.005
GMX-6-1.0	0.5 - 1.0	0.037	<0.005	0.056	0.036
GMX-6-4.5	4.5 - 5.0	<0.005	<0.005	<0.005	<0.005
GMX-7-1.0	0.5 - 1.0	0.008	<0.005	0.009	<0.005
GMX-7-5.0	4.5 - 5.0	0.021	<0.005	0.009	<0.005
GMX-8-1.0	0.5 - 1.0	<0.005	0.023	0.046	<0.005
GMX-8-4.5	4.5 - 5.0	0.008	<0.005	0.010	<0.005

Note:

¹ Soil samples collected by Geomatrix Consultants, Inc. and analyzed by Entech Analytical Laboratories of Sunnyvale, California, for VOCs using EPA Method 8260B.

Abbreviations:

feet bgs = feet below ground surface.

<= indicates result less than the laboratory detection limit indicated.

VOCs = volatile organic compounds.

TABLE 3
SUMMARY OF ANALYTICAL RESULTS
POLYNUCLEAR AROMATIC COMPOUNDS DETECTED IN SOIL SAMPLES¹

Proposed Imperial Parking Area
 Area E - Port of San Francisco Property
 South of China Basin Channel, San Francisco, California

Concentrations are reported in milligrams per kilogram (mg/kg)

Sample I.D.	Sample Interval (feet bgs)	Acenaphthene	Acenaphthylene	Anthracene	Benzo(a)anthracene	Benzo(b)fluoranthene	Benzo(k)fluoranthene	Benzo(g,h,i)perylene	Benzo(a)pyrene	Chrysene	Dibenzo(a,h)anthracene	Fluoranthene	Fluorene	Indeno(1,2,3-cd)pyrene	Naphthalene ²	Phenanthrene	Pyrene
GMX-1-1.0	0.5 - 1.0	<0.04	<0.04	<0.04	<0.04	<0.002	<0.04	<0.04	<0.04	0.089	<0.04	<0.04	<0.04	<0.04	<0.04	<0.04	0.058
GMX-1-4.5	4.5 - 5.0	<0.01	<0.01	0.023	<0.01	0.029	<0.01	<0.01	<0.01	<0.01	<0.01	0.025	<0.01	<0.01	<0.01	0.024	0.029
GMX-2-1.0	0.5 - 1.0	<0.02	0.024	0.103	0.141	<0.002	<0.02	<0.02	<0.02	0.08	<0.02	0.363 ³	<0.02	<0.02	<0.02	0.105	0.415 ³
GMX-2-4.5	4.5 - 5.0	<0.002	0.0024	0.0066	0.022	0.022	0.0048	<0.002	<0.002	0.011	<0.002	0.023	<0.002	<0.002	0.0058	0.0068	0.025
GMX-3-1.0	0.5 - 1.0	<0.02	<0.02	0.078	0.114	<0.002	<0.02	<0.02	<0.02	0.064	<0.02	0.169	<0.02	<0.02	<0.02	0.08	0.16
GMX-3-4.5	4.5 - 5.0	<0.01	<0.01	<0.01	0.025	0.04	<0.01	<0.01	<0.01	0.014	<0.01	0.036	<0.01	<0.01	<0.01	0.024	0.045
GMX-4-1.0	0.5 - 1.0	<0.04	<0.04	<0.04	0.072	<0.04	<0.04	<0.04	<0.04	0.061	<0.04	0.142	<0.04	<0.04	<0.04	0.071	0.183
GMX-4-4.5	4.5 - 5.0	0.053	0.107	0.129	<0.02	<0.2	<0.2	<0.2	0.295	0.18	<0.2	0.628 ⁴	<0.02	<0.2	0.057	0.668 ⁴	0.777 ⁴
GMX-5-1.0	0.5 - 1.0	<0.02	<0.02	<0.02	<0.002	<0.02	<0.02	<0.02	<0.02	<0.02	<0.02	0.032	<0.02	<0.02	<0.02	0.02	0.034
GMX-5-7.0	4.5 - 5.0	<0.002	<0.002	0.026	<0.002	<0.002	<0.002	<0.002	<0.002	0.004	<0.002	0.011	<0.002	<0.002	<0.002	0.026	0.013
GMX-6-1.0	0.5 - 1.0	<0.04	<0.04	<0.04	0.205	<0.04	<0.04	<0.04	<0.04	<0.04	<0.04	0.046	<0.04	<0.04	<0.04	0.06	0.107
GMX-6-4.5	4.5 - 5.0	<0.01	<0.01	0.029	0.122	0.1	0.023	0.038	0.072	0.056	<0.01	0.11	<0.01	0.042	<0.01	0.029	0.111
GMX-7-1.0	0.5 - 1.0	<0.02	<0.02	0.024	0.187	<0.02	<0.02	<0.02	<0.02	0.098	<0.02	0.196	<0.02	<0.02	<0.02	0.194	0.224
GMX-7-5.0	4.5 - 5.0	<0.01	<0.01	<0.01	0.031	<0.01	<0.01	<0.01	<0.01	<0.04	<0.01	<0.01	<0.01	<0.01	<0.04	0.072	<0.01
GMX-8-1.0	0.5 - 1.0	<0.04	<0.04	<0.04	<0.04	<0.04	<0.04	<0.04	<0.04	<0.04	<0.04	0.288	<0.04	<0.04	0.095	0.156	0.374
GMX-8-4.5	4.5 - 5.0	0.019	0.078	<0.01	0.314 ⁴	0.457 ⁴	<0.01	<0.01	<0.01	0.323 ⁴	<0.01	0.772 ⁴	<0.01	<0.01	<0.01	0.288 ⁴	0.680 ⁴

Notes:

¹ Soil samples collected by Geomatrix Consultants, Inc. and analyzed by Advanced Technology Laboratories of Signal Hill, California, for PNAs using EPA Method 8270 SIMS.

² Detected concentration reported as part of EPA Method 8260.

³ Results reported from a 1:100 dilution.

⁴ Results reported from a 1:50 dilution.

Abbreviations:

feet bgs = feet below ground surface.

< = indicates result less than the laboratory detection limit indicated.

PNAs = polynuclear aromatic hydrocarbons.



TABLE 4
SUMMARY OF ANALYTICAL RESULTS
OTHER MAHER PARAMETERS¹
 Proposed Imperial Parking Area
 Area E - Port of San Francisco Property
 South of China Basin Channel, San Francisco, California

Concentrations are reported in milligrams per kilogram (mg/kg) unless noted

Sample I.D.	Sample Interval (feet bgs)	Asbestos	Cyanide	Fluoride	Total Sulfide	pH (no units)	FID (ppmv)
GMX-1-1.0	0.5 - 1.0	<1%	<0.5	<0.5	<0.5	8.4	0
GMX-1-4.5	4.5 - 5.0	NA	NA	NA	NA	NA	
GMX-2-1.0	0.5 - 1.0	NA	NA	NA	NA	NA	100
GMX-2-4.5	4.5 - 5.0	<1%	NA	NA	NA	9.4	
GMX-3-1.0	0.5 - 1.0	NA	NA	NA	NA	NA	0
GMX-3-4.5	4.5 - 5.0	<1%	<0.5	<0.5	<0.5	8.8	
GMX-4-1.0	0.5 - 1.0	<1%	NA	NA	NA	9.4	100
GMX-4-4.5	4.5 - 5.0	NA	NA	NA	NA	NA	
GMX-5-1.0	0.5 - 1.0	<1%	<0.5	<0.5	<0.5	9.1	100
GMX-5-7.0	4.5 - 5.0	NA	NA	NA	NA	NA	
GMX-6-1.0	0.5 - 1.0	NA	NA	NA	NA	NA	1100
GMX-6-4.5	4.5 - 5.0	<1%	NA	NA	NA	9.2	
GMX-7-1.0	0.5 - 1.0	NA	NA	NA	NA	NA	10
GMX-7-5.0	4.5 - 5.0	<1%	<0.5	<0.5	<0.5	9.2	
GMX-8-1.0	0.5 - 1.0	<1%	NA	NA	NA	7.7	150
GMX-8-4.5	4.5 - 5.0	NA	NA	NA	NA	NA	

Note:

¹ Soil samples collected by Geomatrix Consultants, Inc. and analyzed for pH, cyanide, total sulfide, fluoride, and asbestos using EPA Methods 9045, 9010, 9030, and 340.2M, and polarized light microscopy. Analyses performed by Entech Analytical Laboratories, Inc. of Sunnyvale, California (pH and fluoride), Advanced Technology Laboratories of Signal Hill, California (cyanide and total sulfide), and EMSL Analytical, Inc. of Milpitas, California (asbestos).

Abbreviations:

feet bgs = feet below ground surface.

< = analyte not detected at or above method detection limit shown.

NA = not analyzed.

FID = flame ionization detector.

ppmv = parts per million vapor.

TABLE 5
SUMMARY OF ANALYTICAL RESULTS
METALS DETECTED IN GRAB GROUNDWATER SAMPLES¹

Proposed Imperial Parking Area
Area E - Port of San Francisco Property
South of China Basin Channel, San Francisco, California

Concentrations are reported in milligrams per liter (mg/l)

Sample I.D.	Sb	Ar	Ba	Be	Cd	Cr.Total	Co	Cu	Pb	Hg	Mo	Ni	Se	Ag	Tl	V	Zn
GMX-1 ²	0.092/ 0.1	<0.005	0.1	<0.004	<0.005	<0.005	<0.005	<0.005	<0.015	<0.0005	0.018/ 0.02	0.010/ 0.011	<0.015	<0.005	<0.002	<0.010	0.014
GMX-5	<0.005	<0.005	1.7	<0.004	<0.005	0.006	0.008	<0.005	<0.015	<0.0005	0.051	0.006	<0.015	0.034	<0.002	<0.010	0.025

Notes:

¹ Soil samples collected by Geomatrix Consultants, Inc. and analyzed by Entech Analytical Laboratories, of Sunnyvale, California for Title 22 metals using EPA Methods 6000/7000 Series.

² Second result from duplicate sample GMX-11.

Abbreviation:

< = indicates result less than the laboratory detection limit indicated.

Sb = Antimony

Ar = Arsenic

Ba = Barium

Be = Beryllium

Cd = Cadmium

Cr Total = Total Chromium

Co = Cobalt

Cu = Copper

Pb = Lead

Hg = Mercury

Mo = Molybdenum

Ni = Nickel

Se = Selenium

Ag = Silver

Tl = Thallium

V = Vanadium

Zn = Zinc

TABLE 6

SUMMARY OF HEALTH RISK ASSESSMENT RESULTS

Proposed Imperial Weitz Parking Lot Areas

Area E - Port of San Francisco Property

South of China Basin Channel, San Francisco, California

Noncancer Hazard Indexes

Scenario	Incidental Ingestion of Soil	Dermal Contact with Soil	Inhalation of Particulates	Dermal Contact with Groundwater	Hazard Index
Future On-site Construction Worker	6E-02	2E-03	8E-04	7E-03	7E-02
Future On-site Visitor	1E-02	5E-03	7E-07	NA	1E-02

Theoretical Lifetime Excess Cancer Risks

Scenario	Incidental Ingestion of Soil	Dermal Contact with Soil	Inhalation of Particulates	Dermal Contact with Groundwater	Excess Cancer Risk
Future On-site Construction Worker	3E-07	1E-08	7E-08	4E-06	4E-06
Future On-site Visitor	5E-07	3E-07	9E-10	NA	8E-07

Note:

NA = Not applicable

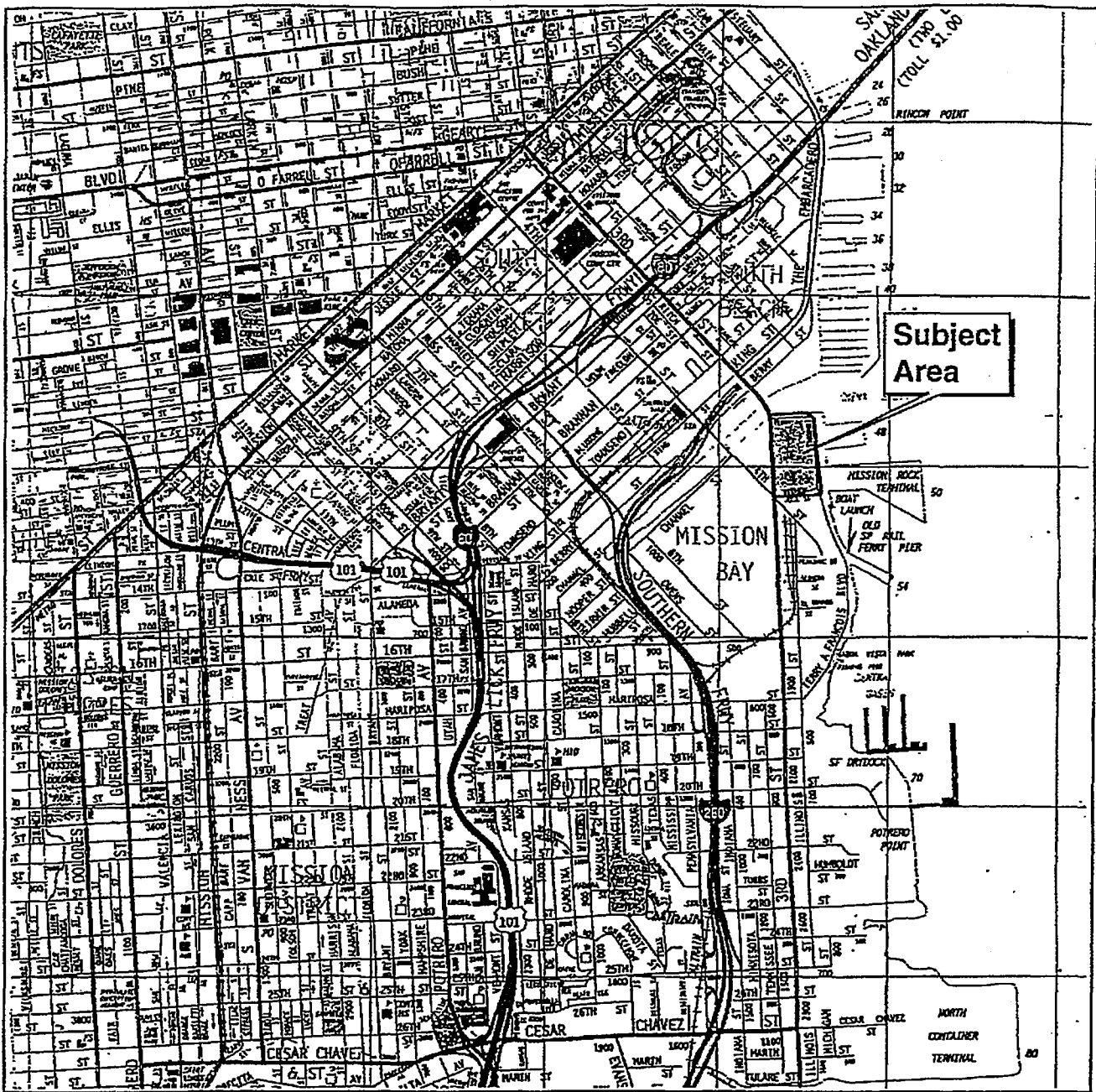

Base map from *The Thomas Guide, 1997 Golden Gate Street Guide and Directory*. Reproduced with permission granted by THOMAS BROS. MAPS. This map is copyrighted by THOMAS BROS. MAPS. It is unlawful to copy or reproduce all or any part thereof, whether for personal use or resale, without permission. All rights reserved.

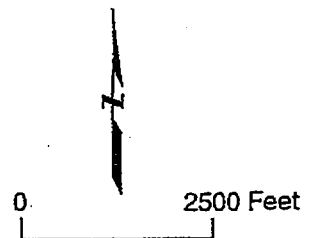

SITE LOCATION MAP
 Proposed Imperial Parking Area
 Area E - San Francisco Port Property
 South of China Basin
 San Francisco, California

Figure
 1
 Project No.
 4952

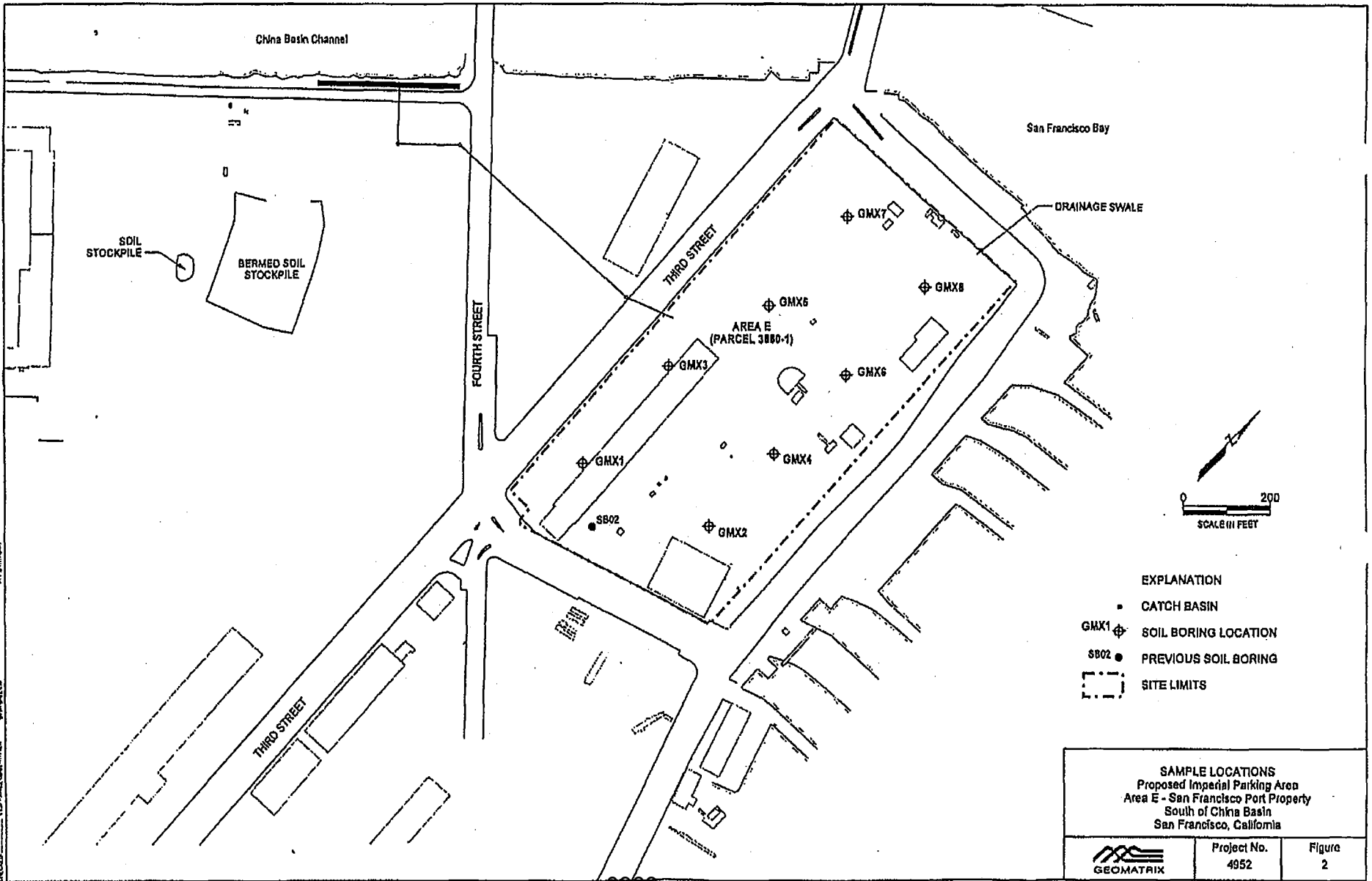

28 MAY 1978 10:23
 24 1800 4 0223 0123 0401 05 0204 04
 112 0202 0302 0402 0502 0602 0702 0802 0902 1002 1102 1202 1302 1402 1502 1602 1702 1802 1902 2002 2102 2202 2302 2402 2502 2602 2702 2802 2902 3002 3102 3202 3302 3402 3502 3602 3702 3802 3902 4002 4102 4202 4302 4402 4502 4602 4702 4802 4902 5002 5102 5202 5302 5402 5502 5602 5702 5802 5902 6002 6102 6202 6302 6402 6502 6602 6702 6802 6902 7002 7102 7202 7302 7402 7502 7602 7702 7802 7902 8002 8102 8202 8302 8402 8502 8602 8702 8802 8902 9002 9102 9202 9302 9402 9502 9602 9702 9802 9902 10002 10102 10202 10302 10402 10502 10602 10702 10802 10902 11002 11102 11202 11302 11402 11502 11602 11702 11802 11902 12002 12102 12202 12302 12402 12502 12602 12702 12802 12902 13002 13102 13202 13302 13402 13502 13602 13702 13802 13902 14002 14102 14202 14302 14402 14502 14602 14702 14802 14902 15002 15102 15202 15302 15402 15502 15602 15702 15802 15902 16002 16102 16202 16302 16402 16502 16602 16702 16802 16902 17002 17102 17202 17302 17402 17502 17602 17702 17802 17902 18002 18102 18202 18302 18402 18502 18602 18702 18802 18902 19002 19102 19202 19302 19402 19502 19602 19702 19802 19902 20002 20102 20202 20302 20402 20502 20602 20702 20802 20902 21002 21102 21202 21302 21402 21502 21602 21702 21802 21902 22002 22102 22202 22302 22402 22502 22602 22702 22802 22902 23002 23102 23202 23302 23402 23502 23602 23702 23802 23902 24002 24102 24202 24302 24402 24502 24602 24702 24802 24902 25002 25102 25202 25302 25402 25502 25602 25702 25802 25902 26002 26102 26202 26302 26402 26502 26602 26702 26802 26902 27002 27102 27202 27302 27402 27502 27602 27702 27802 27902 28002 28102 28202 28302 28402 28502 28602 28702 28802 28902 29002 29102 29202 29302 29402 29502 29602 29702 29802 29902 30002 30102 30202 30302 30402 30502 30602 30702 30802 30902 31002 31102 31202 31302 31402 31502 31602 31702 31802 31902 32002 32102 32202 32302 32402 32502 32602 32702 32802 32902 33002 33102 33202 33302 33402 33502 33602 33702 33802 33902 34002 34102 34202 34302 34402 34502 34602 34702 34802 34902 35002 35102 35202 35302 35402 35502 35602 35702 35802 35902 36002 36102 36202 36302 36402 36502 36602 36702 36802 36902 37002 37102 37202 37302 37402 37502 37602 37702 37802 37902 38002 38102 38202 38302 38402 38502 38602 38702 38802 38902 39002 39102 39202 39302 39402 39502 39602 39702 39802 39902 40002 40102 40202 40302 40402 40502 40602 40702 40802 40902 41002 41102 41202 41302 41402 41502 41602 41702 41802 41902 42002 42102 42202 42302 42402 42502 42602 42702 42802 42902 43002 43102 43202 43302 43402 43502 43602 43702 43802 43902 44002 44102 44202 44302 44402 44502 44602 44702 44802 44902 45002 45102 45202 45302 45402 45502 45602 45702 45802 45902 46002 46102 46202 46302 46402 46502 46602 46702 46802 46902 47002 47102 47202 47302 47402 47502 47602 47702 47802 47902 48002 48102 48202 48302 48402 48502 48602 48702 48802 48902 49002 49102 49202 49302 49402 49502 49602 49702 49802 49902 50002 50102 50202 50302 50402 50502 50602 50702 50802 50902 51002 51102 51202 51302 51402 51502 51602 51702 51802 51902 52002 52102 52202 52302 52402 52502 52602 52702 52802 52902 53002 53102 53202 53302 53402 53502 53602 53702 53802 53902 54002 54102 54202 54302 54402 54502 54602 54702 54802 54902 55002 55102 55202 55302 55402 55502 55602 55702 55802 55902 56002 56102 56202 56302 56402 56502 56602 56702 56802 56902 57002 57102 57202 57302 57402 57502 57602 57702 57802 57902 58002 58102 58202 58302 58402 58502 58602 58702 58802 58902 59002 59102 59202 59302 59402 59502 59602 59702 59802 59902 60002 60102 60202 60302 60402 60502 60602 60702 60802 60902 61002 61102 61202 61302 61402 61502 61602 61702 61802 61902 62002 62102 62202 62302 62402 62502 62602 62702 62802 62902 63002 63102 63202 63302 63402 63502 63602 63702 63802 63902 64002 64102 64202 64302 64402 64502 64602 64702 64802 64902 65002 65102 65202 65302 65402 65502 65602 65702 65802 65902 66002 66102 66202 66302 66402 66502 66602 66702 66802 66902 67002 67102 67202 67302 67402 67502 67602 67702 67802 67902 68002 68102 68202 68302 68402 68502 68602 68702 68802 68902 69002 69102 69202 69302 69402 69502 69602 69702 69802 69902 70002 70102 70202 70302 70402 70502 70602 70702 70802 70902 71002 71102 71202 71302 71402 71502 71602 71702 71802 71902 72002 72102 72202 72302 72402 72502 72602 72702 72802 72902 73002 73102 73202 73302 73402 73502 73602 73702 73802 73902 74002 74102 74202 74302 74402 74502 74602 74702 74802 74902 75002 75102 75202 75302 75402 75502 75602 75702 75802 75902 76002 76102 76202 76302 76402 76502 76602 76702 76802 76902 77002 77102 77202 77302 77402 77502 77602 77702 77802 77902 78002 78102 78202 78302 78402 78502 78602 78702 78802 78902 79002 79102 79202 79302 79402 79502 79602 79702 79802 79902 80002 80102 80202 80302 80402 80502 80602 80702 80802 80902 81002 81102 81202 81302 81402 81502 81602 81702 81802 81902 82002 82102 82202 82302 82402 82502 82602 82702 82802 82902 83002 83102 83202 83302 83402 83502 83602 83702 83802 83902 84002 84102 84202 84302 84402 84502 84602 84702 84802 84902 85002 85102 85202 85302 85402 85502 85602 85702 85802 85902 86002 86102 86202 86302 86402 86502 86602 86702 86802 86902 87002 87102 87202 87302 87402 87502 87602 87702 87802 87902 88002 88102 88202 88302 88402 88502 88602 88702 88802 88902 89002 89102 89202 89302 89402 89502 89602 89702 89802 89902 90002 90102 90202 90302 90402 90502 90602 90702 90802 90902 91002 91102 91202 91302 91402 91502 91602 91702 91802 91902 92002 92102 92202 92302 92402 92502 92602 92702 92802 92902 93002 93102 93202 93302 93402 93502 93602 93702 93802 93902 94002 94102 94202 94302 94402 94502 94602 94702 94802 94902 95002 95102 95202 95302 95402 95502 95602 95702 95802 95902 96002 96102 96202 96302 96402 96502 96602 96702 96802 96902 97002 97102 97202 97302 97402 97502 97602 97702 97802 97902 98002 98102 98202 98302 98402 98502 98602 98702 98802 98902 99002 99102 99202 99302 99402 99502 99602 99702 99802 99902 100002 1000102 1000202 1000302 1000402 1000502 1000602 1000702 1000802 1000902 1001002 1001102 1001202 1001302 1001402 1001502 1001602 1001702 1001802 1001902 1002002 1002102 1002202 1002302 1002402 1002502 1002602 1002702 1002802 1002902 1003002 1003102 1003202 1003302 1003402 1003502 1003602 1003702 1003802 1003902 1004002 1004102 1004202 1004302 1004402 1004502 1004602 1004702 1004802 1004902 1005002 1005102 1005202 1005302 1005402 1005502 1005602 1005702 1005802 1005902 1006002 1006102 1006202 1006302 1006402 1006502 1006602 1006702 1006802 1006902 1007002 1007102 1007202 1007302 1007402 1007502 1007602 1007702 1007802 1007902 1008002 1008102 1008202 1008302 1008402 1008502 1008602 1008702 1008802 1008902 1009002 1009102 1009202 1009302 1009402 1009502 1009602 1009702 1009802 1009902 1010002 1010102 1010202 1010302 1010402 1010502 1010602 1010702 1010802 1010902 1011002 1011102 1011202 1011302 1011402 1011502 1011602 1011702 1011802 1011902 1012002 1012102 1012202 1012302 1012402 1012502 1012602 1012702 1012802 1012902 1013002 1013102 1013202 1013302 1013402 1013502 1013602 1013702 1013802 1013902 1014002 1014102 1014202 1014302 1014402 1014502 1014602 1014702 1014802 1014902 1015002 1015102 1015202 1015302 1015402 1015502 1015602 1015702 1015802 1015902 1016002 1016102 1016202 1016302 1016402 1016502 1016602 1016702 1016802 1016902 1017002 1017102 1017202 1017302 1017402 1017502 1017602 1017702 1017802 1017902 1018002 1018102 1018202 1018302 1018402 1018502 1018602 1018702 1018802 1018902 1019002 1019102 1019202 1019302 1019402 1019502 1019602 1019702 1019802 1019902 1020002 1020102 1020202 1020302 1020402 1020502 1020602 1020702 1020802 1020902 1021002 1021102 1021202 1021302 1021402 1021502 1021602 1021702 1021802 1021902 1022002 1022102 1022202 1022302 1022402 1022502 1022602 1022702 1022802 1022902 1023002 1023102 1023202 1023302 1023402 1023502 1023602 1023702 1023802 1023902 1024002 1024102 1024202 1024302 1024402 1024502 1024602 1024702 1024802 1024902 1025002 1025102 1025202 1025302 1025402 1025502 1025602 1025702 1025802 1025902 1026002 1026102 1026202 1026302 1026402 1026502 1026602 1026702 1026802 1026902 1027002 1027102 1027202 1027302 1027402 1027502 1027602 1027702 1027802 1027902 1028002 1028102 1028202 1028302 1028402 1028502 1028602 1028702 1028802 1028902 1029002 1029102 1029202 1029302 1029402 1029502 1029602 1029702 1029802 1029902 1030002 1030102 1030202 1030302 1030402 1030502 1030602 1030702 1030802 1030902 1031002 1031102 1031202 1031302 1031402 1031502 1031602 1031702 1031802 1031902 1032002 1032102 1032202 1032302 1032402 1032502 1032602 1032702 1032802 1032902 1033002 1033102 1033202 1033302 1033402 1033502 1033602 1033702 1033802 1033902 1034002 1034102 1034202 1034302 1034402 1034502 1034602 1034702 1034802 1034902 1035002 1035102 1035202 1035302 1035402 1035502 1035602 1035702 1035802 1035902 1036002 1036102 1036202 1036302 1036402 1036502 1036602 1036702 1036802 1036902 1037002 1037102 1037202 1037302 1037402 1037502 1037602 1037702 1037802 1037902 1038002 1038102 1038202 1038302 1038402 1038502 1038602 1038702 1038802 1038902 1039002 1039102 1039202 1039302 1039402 1039502 1039602 1039702 1039802 1039902 1040002 1040102 1040202 1040302 1040402 1040502 1040602 1040702 1040802 1040902 1041002 1041102 1041202 1041302 1041402 1041502 1041602 1041702 1041802 1041902 1042002 1042102 1042202 1042302 1042402 1042502 1042602 1042702 1042802 1042902 1043002 1043102 1043202 1043302 1043402 1043502 1043602 1043702 1043802 1043902 1044002 1044102 1044202 1044302 1044402 1044502 1044602 1044702 1044802 1044902 1045002 1045102 1045202 1045302 1045402 1045502 1045602 1045702 1045802 1045902 1046002 1046102 1046202 1046302 1046402 1046502 1046602 1046702 1046802 1046902 1047002 1047102 1047202 1047302 1047402 1047502 1047602 1047702 1047802 1047902 1048002 1048102 1048202 1048302 1048402 1048502 1048602 1048702 1048802 1048902 1049002 1049102 1049202 1049302 1049402 1049502 1049602 1049702 1049802 1049902 1050002 1050102 1050202 1050302 1050402 1050502 1050602 1050702 1050802 1050902 1051002 1051102 1051202 1051302 1051402 1051502 1051602 1051702 1051802 1051902 1052002 1052102 1052202 1052302 1052402 1052502 1052602 1052702 1052802 1052902 1053002 1053102 1053202 1053302 1053402 1053502 1053602 1053702 1053802 1053902 1054002 1054102 1054202 1054302 1054402 1054502 1054602 1054702 1054802 1054902 1055002 1055102 1055202 1055302 1055402 1055502 1055602 1055702 1055802 1055902 1056002 1056102 1056202 1056302 1056402 1056502 1056602 1056702 1056802 1056902 1057002 1057102 1057202 1057302 1057402 1057502 1057602 1057702 1057802 1057902 1058002 1058102 1058202 1058302 1058402 1058502 1058602 1058702 1058802 1058902 1059002 1059102 1059202 1059302 1059402 1059502 1059602 1059702 1059802 1059902 1060002 1060102 1060202 1060302 1060402 1060502 1060602 1060702 1060802 1060902 1061002 1061102 1061202 1061302 1061402 1061502 1061602 1061702 1061802 1061902 1062002 1062102 1062202 1062302 1062402 1062502 1062602 1062702 1062802 1062902 1063002 1063102 1063202 1063302 1063402 1063502 1063602 1063702 1063802 1063902 1064002 1064102 1064202 1064302 1064402 1064502 1064602 1064702 1064802 1064902 1065002 1065102 1065202 1065302 1065402 1065502 1065602 1065702 1065802 1065902 1066002 1066102 1066202 1066302 1066402 1066502 1066602 1066702 1066802 1066902 1067002 1067102 1067202 1067302 1067402 1067502 1067602 1067702 1067802 1067902 1068002 1068102 1068202 1068302 1068402 1068502 1068602 1068702 1068802 1068902 1069002 1069102 1069202 1069302 1069402 1069502 1069602 1069702 1069802 1069902 1070002 1070102 1070202 1070302 1070402 1070502 1070602 1070702 1070802 1070902 1071002 1071102 1071202 1071302 1071402 1071502 1071602 1071702 1071802 1071902 1072002 1072102 1072202 1072302 1072402 1072502 1072602 1072702 1072802 1072902 1073002 1073102 1073202 1073302 1073402 1073502 1073602 1073702 1073802 1073902 1074002 1074102 1074202 1074302 10

APPENDIX A

Data Summaries from Previous Investigations

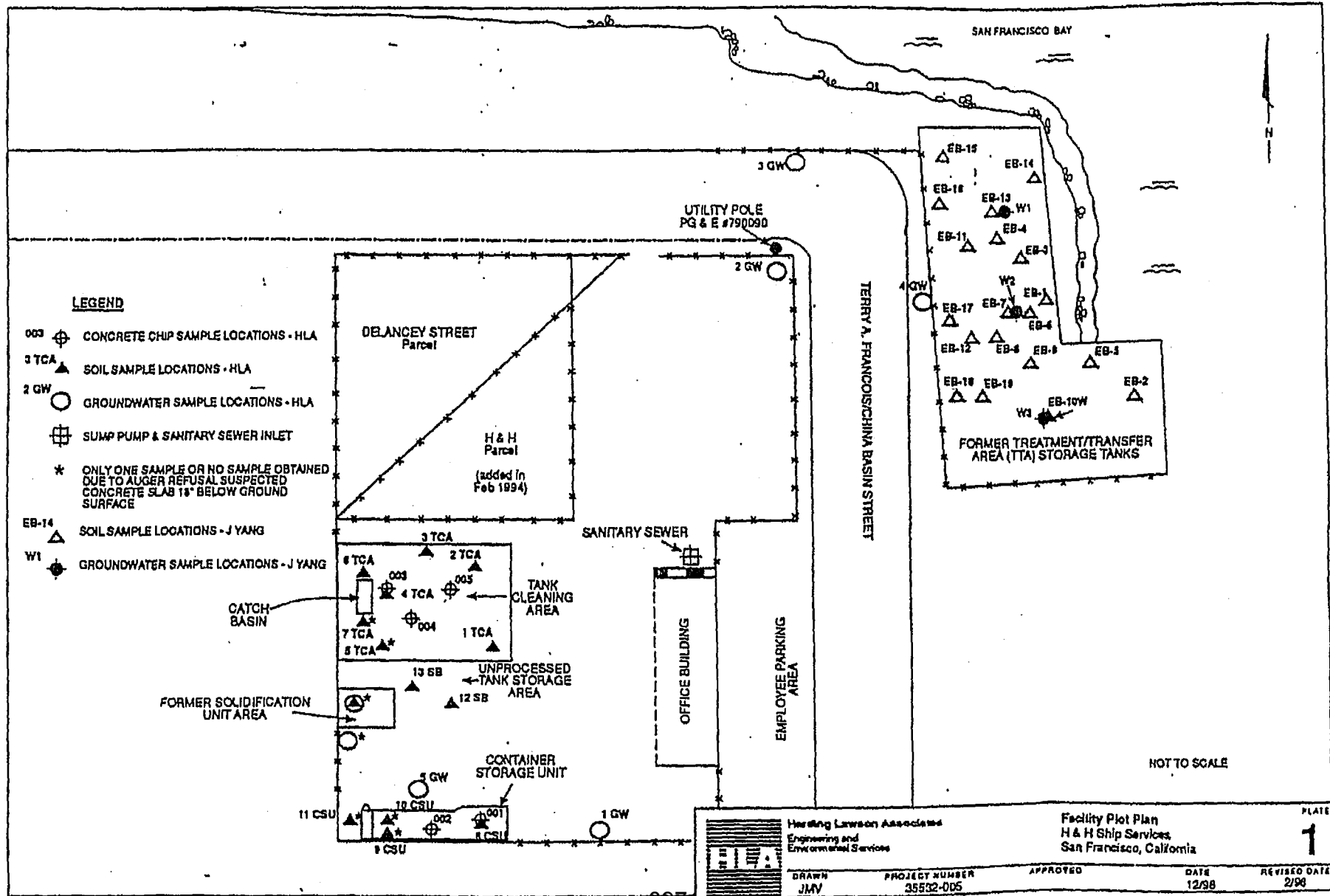

	Herling Lawson Associates Engineering and Environmental Services	Facility Plot Plan H & H Ship Services San Francisco, California	PLATE 1	
	DRAWN JMV	PROJECT NUMBER 35532-005	APPROVED	DATE 12/98

Table 4. Summary of Chemicals Detected In Soil
 Tank Cleaning Area, Container Storage Unit, and Solidification Unit
 H & H Ship Service Company
 San Francisco, California

Analyte	Units	Number of Detections	Number of Analyses	Frequency of Detection	Minimum Detected Conc.	Maximum Detected Conc.	Location of Maximum Conc.
Inorganics							
Arsenic	mg/kg	16	17	94%	ND	9.2E+01	3TCA-008
Barium	mg/kg	17	17	100%	3.8E+01	6.5E+02	12SB-023
Cadmium	mg/kg	1	17	6%	ND	5.3E-01	3TCA-008
Chromium	mg/kg	17	17	100%	7.3E+00	7.0E+01	1TCA-001
Cobalt	mg/kg	17	17	100%	3.8E+00	4.0E+01	3TCA-007
Copper	mg/kg	17	17	100%	8.9E+00	1.4E+02	10CSU-021
Lead	mg/kg	18	17	94%	ND	2.1E+02	1TCA-001
Mercury	mg/kg	16	17	94%	ND	4.8E-01	2TCA-005
Nickel	mg/kg	17	17	100%	1.3E+01	3.2E+02	6TCA-014
Silver	mg/kg	3	17	18%	ND	3.0E+00	3TCA-007
Thallium	mg/kg	11	17	65%	ND	1.1E+01	1TCA-001
Vanadium	mg/kg	17	17	100%	1.8E+01	4.8E+01	5TCA-013
Zinc	mg/kg	17	17	100%	3.2E+01	2.5E+02	4TCA-011
Petroleum							
Oil and Grease (Total)	mg/kg	17	17	100%	1.1E+02	6.4E+03	4TCA-011
Oil and Grease (Non-Polar)	mg/kg	18	17	94%	ND	5.0E+03	3TCA-007
TPH-Diesel	mg/kg	17	17	100%	5.0E+00	2.1E+03	4TCA-011
TPH-Gasoline	mg/kg	4	17	24%	ND	1.0E+02	4TCA-011
Toluene	mg/kg	17	17	100%	1.2E-02	1.3E+00	3TCA-007
Ethylbenzene	mg/kg	3	17	18%	ND	6.3E-01	4TCA-011
Xylene	mg/kg	6	17	35%	ND	9.3E+00	4TCA-011
PCBs							
Aroclor 1018	mg/kg	2	17	12%	ND	1.0E-01	5TCA-013
Aroclor 1254	mg/kg	7	17	41%	ND	2.4E-01	5TCA-013
Aroclor 1280	mg/kg	3	17	18%	ND	5.5E-01	5TCA-013
PAHs							
Acenaphthene	mg/kg	2	17	12%	ND	9.3E-01	8CSU-018
Acanaphthylene	mg/kg	3	17	18%	ND	1.5E+00	8CSU-018
Anthracene	mg/kg	5	17	29%	ND	3.1E+00	8CSU-018
Benz(a)anthracene	mg/kg	11	17	65%	ND	2.4E+00	8CSU-018
Benzo(b,k)fluoranthene	mg/kg	11	17	65%	ND	2.6E+00	8CSU-018
Benzo(a)pyrene	mg/kg	10	17	59%	ND	1.8E+00	8CSU-018
Benzo(g,h,i)perylene	mg/kg	10	17	59%	ND	6.6E-01	8CSU-018
Chrysene	mg/kg	11	17	65%	ND	2.3E+00	8CSU-018
Dibenz(a,h)anthracene	mg/kg	7	17	41%	ND	3.7E-01	8CSU-018
Fluoranthene	mg/kg	14	17	82%	ND	4.3E+00	8CSU-018
Fluorene	mg/kg	5	17	29%	ND	3.7E+00	8CSU-018
Indeno(1,2,3-cd)pyrene	mg/kg	9	17	53%	ND	7.0E-01	8CSU-018
Naphthalene	mg/kg	5	17	29%	ND	2.5E+00	4TCA-011
Phenanthrene	mg/kg	15	17	88%	ND	6.3E+00	8CSU-018
Pyrene	mg/kg	15	17	88%	ND	4.7E+00	8CSU-018

mg/kg Milligrams per kilogram.
 Note: Only detected compounds are listed.

**Table 8. Summary of Chemicals Detected In Groundwater
Tank Cleaning Area, Container Storage Unit, and Solidification Unit
H & H Ship Service Company
San Francisco, California**

Chemical	Units	Number of Detections	Number of Analyses	Frequency of Detection	Minimum Detected Concentration	Maximum Detected Concentration	Location of Maximum Concentration
Inorganics (filtered)							
Arsenic	mg/L	1	5	20%	0.812	0.812	3GW
Barium	mg/L	5	5	100%	0.0847	0.748	3GW
Cobalt	mg/L	1	5	20%	0.0165	0.0165	2GW
Molybdenum	mg/L	1	5	20%	0.0207	0.0207	4GW
Nickel	mg/L	2	5	40%	0.0419	0.0683	2GW
Zinc	mg/L	1	5	20%	0.128	0.128	4GW
Inorganics (unfiltered)							
Arsenic	mg/L	2	4	50%	0.3	9.2	1GW
Barium	mg/L	4	4	100%	0.27	5.1	1GW
Cadmium	mg/L	3	4	75%	0.012	0.026	1GW
Chromium	mg/L	4	4	100%	0.049	1.1	3GW
Cobalt	mg/L	4	4	100%	0.31	2.5	3GW
Copper	mg/L	4	4	100%	0.056	2	2GW
Lead	mg/L	4	4	100%	0.66	5.8	2GW
Mercury	mg/L	4	4	100%	0.0017	2	4GW
Nickel	mg/L	4	4	100%	0.32	12	3GW
Thallium	mg/L	1	4	25%	0.15	0.15	1GW
Vanadium	mg/L	3	4	75%	0.061	0.47	1GW
Zinc	mg/L	4	4	100%	1	7.2	1GW
Petroleum (unfiltered)							
TPH-Diesel	mg/L	1	4	25%	2.4	2.4	1GW
PCBs (unfiltered) None Detected							
PAHs (unfiltered)							
Acenaphthylene	µg/L	1	5	20%	0.5	0.5	1GW
Anthracene	µg/L	1	5	20%	1.1	1.1	1GW
Benz(a)anthracene	µg/L	3	5	60%	0.14	5.1	1GW
Benzo(b)fluoranthene	µg/L	1	1	100%	0.56	0.56	5GW
Benzo(k)fluoranthene	µg/L	1	1	100%	0.12	0.12	5GW
Benzo(b,k)fluoranthene	µg/L	3	4	75%	0.6	10	1GW
Benzo(a)pyrene	µg/L	3	5	60%	0.34	6.8	1GW
Benzo(g,h,i)perylene	µg/L	3	5	60%	0.5	5.5	1GW
Chrysene	µg/L	2	5	40%	7	7	1GW
Dibenz(a,h)anthracene	µg/L	1	5	20%	1.2	1.2	1GW
Fluoranthene	µg/L	3	5	60%	0.7	10	1GW
Fluorene	µg/L	1	5	20%	1.5	1.5	5GW
Indeno(1,2,3-cd)pyrene	µg/L	1	5	20%	4.2	4.2	1GW
Naphthalene	µg/L	3	5	60%	0.5	1.1	5GW
Phenanthrene	µg/L	4	5	80%	0.5	4.8	1GW
Pyrene	µg/L	4	5	80%	0.6	10	1GW
PAHs (filtered) None Detected							

mg/L Milligrams per liter.

µg/L Micrograms per liter.

ND Not detected.

NA Not available.

Note: Only detected analytes are listed.

APPENDIX B

Site Plans Illustrating Alternative Storm Drainage Systems

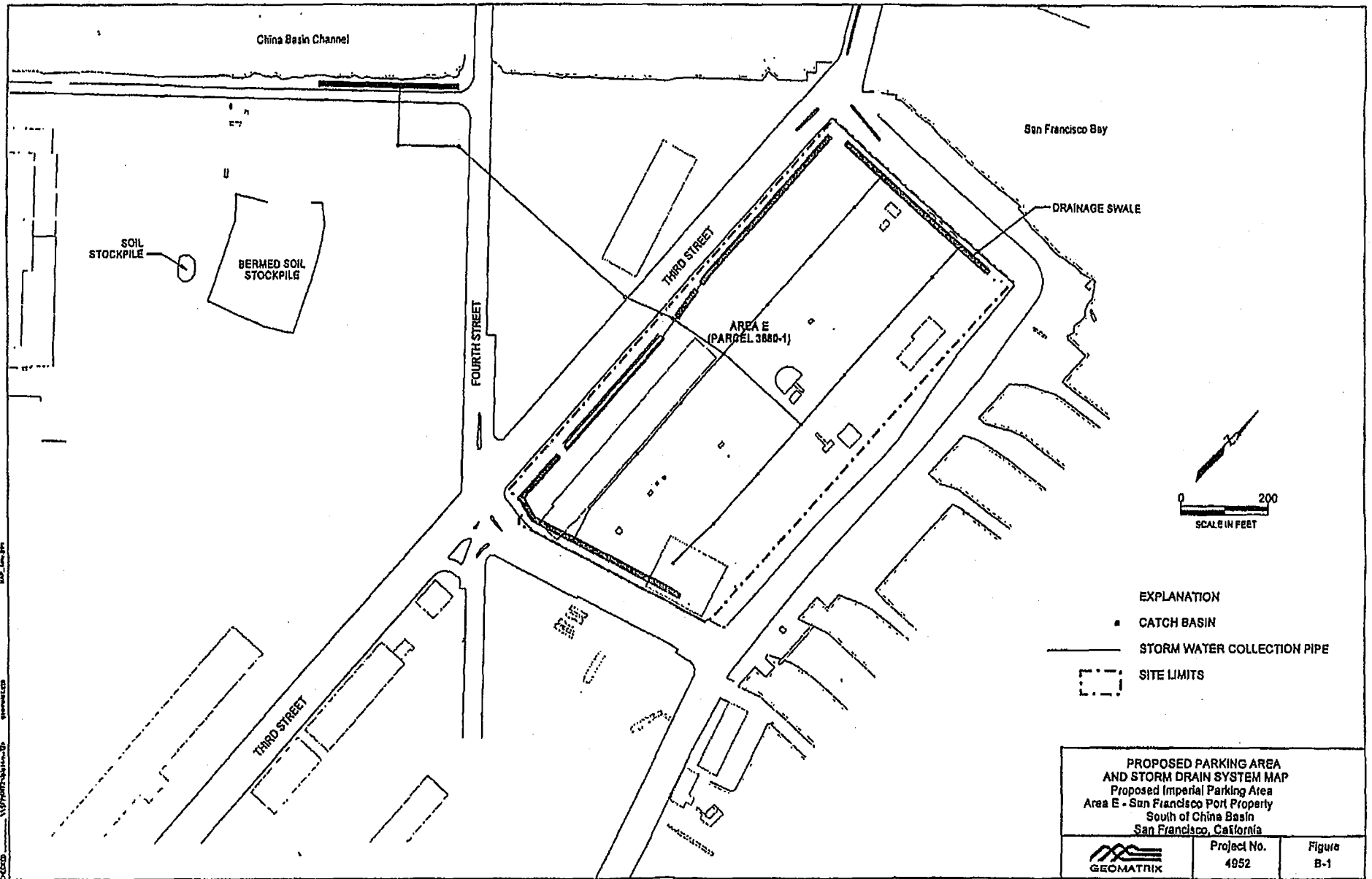

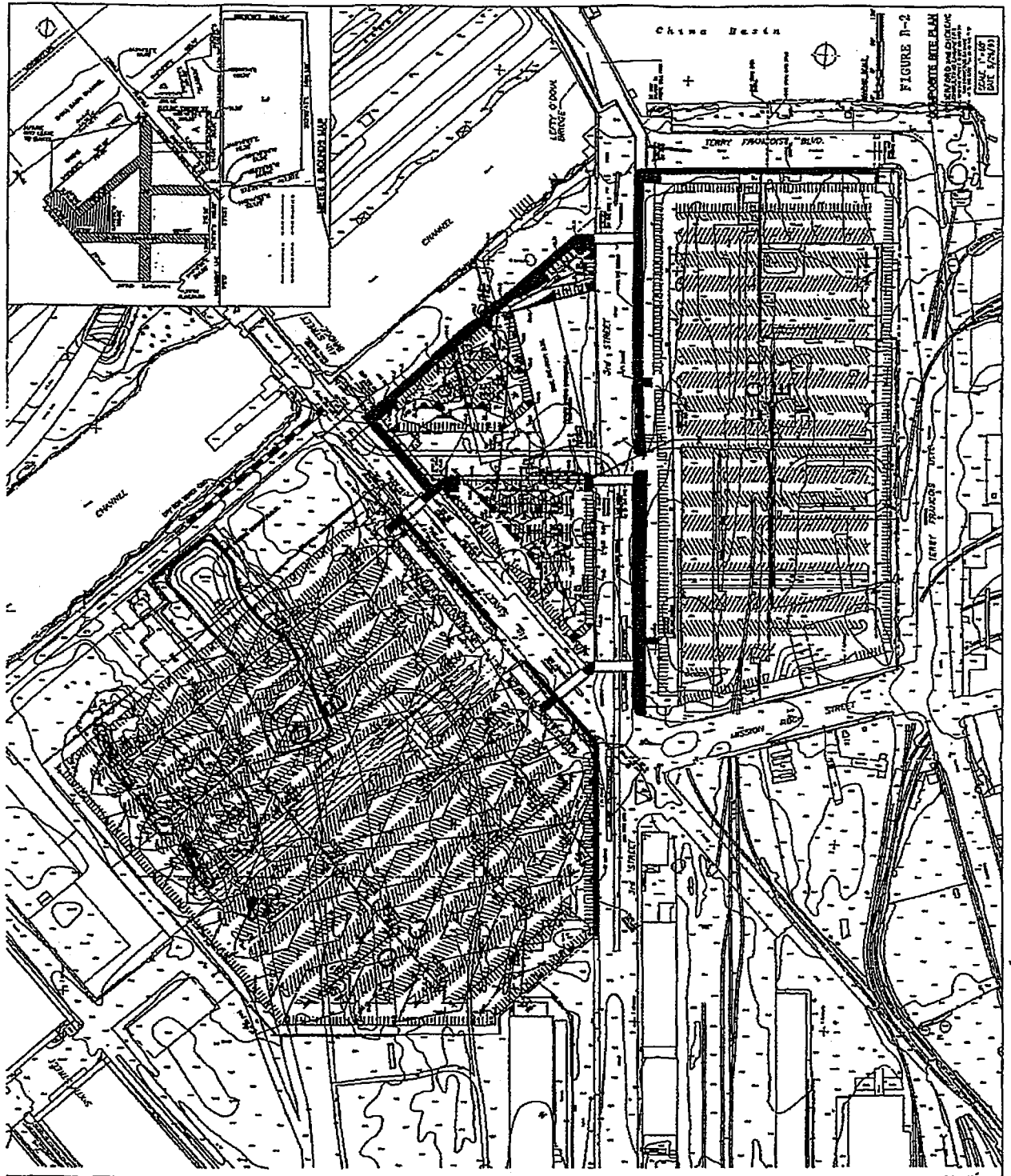

APPENDIX D
Covenant to Restrict Use of Property
Recorded January 27, 2000



RECORDING REQUESTED BY:
The Port of San Francisco
Ferry Building
San Francisco, California 94111

San Francisco Assessor-Recorder
Doris M. Ward, Assessor-Recorder
DOC- 2000-G723986-00

Acct 25-NO CHARGE DOCUMENT
Thursday, JAN 27, 2000 10:47:55
FRE \$0.00
Ttl Pd \$0.00
Nbr-0001346614
REEL H561 IMAGE 0199 ced/ER/1-16

WHEN RECORDED, MAIL TO:

Department of Toxic Substances Control
700 Heinz Avenue, Suite 300
Berkeley, California 94710
Attention: Mohinder S. Sandhu, P.E., Chief
Standardized Permits and Corrective
Action Branch

N/c
16

SPACE ABOVE THIS LINE RESERVED FOR RECORDER'S USE

COVENANT TO RESTRICT USE OF PROPERTY

ENVIRONMENTAL RESTRICTION

(Re: H&H Site located at Seawall Lot 337, City and County of San Francisco)

This Covenant and Agreement ("Covenant") is made by and between COVENANT TO RESTRICT USE OF PROPERTY

ENVIRONMENTAL RESTRICTION

Re: H&H Site located at Seawall Lot 337, City and County of San Francisco

This Covenant and Agreement ("Covenant") is made by and between the City and County of San Francisco, a charter city and county in trust (the "Covenantor"), the current owner, of certain property situated in the City and County of San Francisco, State of California, described in Exhibit "A", attached hereto and incorporated herein by this reference (the "Property"), and the Department of Toxic Substances Control (the

"Department"). Pursuant to Civil Code section 1471(c), the Department has determined that this Covenant is reasonably necessary to protect present or future human health or safety or the environment as a result of the presence on the land of hazardous materials as defined in Health and Safety Code ("H&SC") section 25260. The Covenantor and the Department, collectively referred to as the "Parties", therefore intend that the use of the Property be restricted as set forth in this Covenant, in order to protect human health, safety and the environment.

ARTICLE I
STATEMENT OF FACTS

1.01. The Property, totaling approximately 14 acres, is more particularly described in Exhibit "A" and depicted in Exhibit "A-1", attached hereto and incorporated herein by this reference. The Property is located in the area now generally bounded by Terry Francois Boulevard on the North and East, in the City and County of San Francisco, California.

1.02. The site was created by filling marshlands and shallow tidal flats bordering San Francisco Bay between 1877 and 1913. Sources of fill are unknown, but likely included construction/demolition debris and rubble, and rock and dirt cut from nearby hills. Historical uses of the Site include railroad tracks and related support structures, parking and shipping by truck, and truck maintenance. From 1950 to 1996 H&H Ship Service operated a hazardous waste treatment facility, including a tank cleaning area and drum storage unit, and used portions of the Property for vehicle parking and offices.

In 1978 several of the wastes managed at the H&H Ship Service facility were determined to be hazardous wastes subject to federal and state hazardous waste management regulations. Since that time, the Department of Toxic Substances Control (or its predecessor in interest, the Department of Health Services) authorized H&H Ship Service's operations pursuant to an interim status document. Under this authorization the property was a hazardous waste facility (Facility), regulated by the Department, subject to the requirements of the California Hazardous Waste Control Law ("HWCL"), at Health and Safety Code ("H&S Code") section 25100 et seq., and the federal Resource Conservation and Recovery Act ("RCRA"), at 42 U.S.C. section 6901 et seq.

The Department is requiring this Covenant pursuant to the closure requirements of the HWCL, including H&S Code section 25246 and post-closure notices provisions of Title 22 California Code of Regulations [section 66265.119(b) for interim status hazardous waste facilities], as part of the facility closure. The Department circulated a closure plan, dated August 30, 1996 and a draft Categorical Exemption pursuant to the California Environmental Quality Act, Public Resources Code section 21000 et seq for

public review and comment from December 23, 1999 to January 24, 2000. The Department approved the closure plan, closure certification report titled, *RCRA Closure Certification Report, Former H&H Ship Service Facility, San Francisco, California, dated February 4, 1999*, containing a health risk assessment, and the Categorical Exemption on January 26, 2000. Hazardous wastes, which are also hazardous materials as defined in Health and Safety Code sections 25117 and 25260, including petroleum hydrocarbons, polynuclear aromatic hydrocarbons, metals and arsenic, remain in the soil and groundwater at the Site at concentrations below those which would pose a significant human health risk under proposed reuse scenarios. The health risk assessment did not evaluate an unrestricted land use scenario, recreational use involving direct contact with soil, or potential impacts from use of groundwater. Therefore a deed restriction to limit use of the property to those exposure scenarios evaluated and found to be below acceptable risk limits is required as part of the facility closure.

1.03. As detailed in the health risk assessment within the *RCRA Closure Certification Report*, as approved by the Department on January 26, 2000, portions of the surface and subsurface soils on the Site contain hazardous wastes and hazardous materials, as defined in H&S Code section 25117 and 25260, including the following contaminants of concern: arsenic (up to 92 mg/kg) and benzo(a)pyrene (up to 2.5 mg/kg). Groundwater beneath the Property is found within 10 to 20 feet below ground surface. Dissolved arsenic was found in groundwater at up to 812 ug/l. California drinking water standards are arsenic at 50 ug/l. Because the health risk assessment did not evaluate an unrestricted land use scenario, recreational use involving direct contact with soil, or potential impacts from use of groundwater, the Department concluded that use of the Property as a residence, hospital, school for persons under the age of 21, day care center, or recreational use involving direct contact with soil would entail an unacceptable potential human health risk. The Department further concluded that the Property, subject to the restrictions of this Covenant, does not present an unacceptable threat to human safety or the environment.

ARTICLE II DEFINITIONS

2.01. Department. "Department" shall mean the California Department of Toxic Substances Control and shall include its successor agencies, if any.

2.02. Owner. "Owner" shall mean the Covenantor, its successors in interest, and their successors in interest, including heirs and assigns, who at any time hold title to all or any portion of the Property.

2.03. Occupant. "Occupant" shall mean Owners and any person or entity entitled by ownership, leasehold, or other legal relationship to the right to occupy any portion of the Property.

ARTICLE III
GENERAL PROVISIONS

3.01. Restrictions to Run With the Land. This Covenant sets forth protective provisions, covenants, restrictions, and conditions (collectively referred to as "Restrictions"), upon and subject to which the Property and every portion thereof shall be improved, held, used, occupied, leased, sold, hypothecated, encumbered, and/or conveyed. Each and every one of the Restrictions: (a) shall run with the land pursuant to H&SC sections 25202.5, and 25202.6 and Civil Code section 1471; (b) shall inure to the benefit of and pass with each and every portion of the Property, (c) shall apply to and bind the respective successors in interest to the Property, (d) are for the benefit of, and shall be enforceable by the Department, and (e) are imposed upon the entire Property unless expressly stated as applicable only to a specific portion thereof.

3.02. Binding Upon Owners/Occupants. Pursuant to Health and Safety Code section 25202.5(b), this Covenant shall be binding upon all of the owners of the land, their heirs, successors, and assignees, and the agents, employees, and lessees of the owners, heirs, successors, and assignees. Pursuant to Civil Code section 1471(b), all successive owners of the Property are expressly bound hereby for the benefit of the covenantee(s) herein. "Owner" shall include "Covenantor".

3.04. Written Notice of Hazardous Substance Release. The Owner shall, prior to the sale, lease, or rental of the Property, give written notice that a release of hazardous substances has come to be located on or beneath the Property, pursuant to Health and Safety Code section 25359.7. Such written notice shall include a copy of this Covenant.

ARTICLE IV
RESTRICTIONS

4.01. Prohibited Uses. The Property shall not be used for any of the following purposes:

- (a) A residence, including any mobile home or factory built housing, constructed or installed for use as residential human habitation;
- (b) A hospital for humans;
- (c) A public or private school for persons under 21 years of age;
- (d) A day care center for children; or
- (e) Recreational use involving direct contact with soil.

4.02. Soil Management

- (a) Any contaminated soils brought to the surface by grading, excavation, trenching or backfilling shall be managed in accordance with all applicable provisions of state and federal law.
- (b) If more than 50 cubic yards of any surface or subsurface soil will be disturbed, including excavation and grading, then the soil shall be evaluated for potential human health risks in compliance with Article 20 of the SF Municipal Code ("the Maher Ordinance"), and managed accordingly.

4.03. Prohibited Activities. The following activities shall not be conducted at the Property:

- (a) No raising of food (e.g., cattle, food crops, cotton, etc.) shall be permitted on the property.
- (b) No groundwater shall be extracted on the Property for purposes other than site remediation or construction dewatering without prior written approval by the Department.

4.04. Access for Department. Covenantor agrees that the Department shall have reasonable right of entry and access to the Property for inspection, monitoring, and other activities consistent with the purposes of this Covenant as deemed necessary by the Department in order to protect the public health and safety.

ARTICLE V
ENFORCEMENT

5.01. Enforcement. Failure of the Covenantor and/or Owner to comply with any of the Restrictions specifically applicable to it shall be grounds for the Department, by reason of this Covenant, to require that the Covenantor and/or Owner modify or remove any improvements ("Improvements" herein shall mean all buildings, roads, driveways, and paved parking areas, constructed or placed upon any portion of the Property constructed in violation of the Restrictions.) Violation of this Covenant shall be grounds for the Department to file civil and/or criminal actions against the Covenantor and/or Owner as provided by law.

ARTICLE VI
VARIANCE, TERMINATION, AND TERM

6.01. Variance. Any Owner or, with the Owner's written consent, any Occupant of the Property or any portion thereof may apply to the Department for a written variance from the provisions of this Covenant. Such application shall be made in accordance with H&S Code section 25202.6.

6.02. Termination. Any Owner, and/or, with the Owner's written consent, any Occupant of the Property, or any portion thereof, may apply to the Department for a termination of the Restrictions or other terms of this Covenant as they apply to all or any portion of the Property. Such application shall be made in accordance with H&S Code section 25202.6.

6.03. Term. Unless ended in accordance with the Termination Paragraph above, by law, or by the Department in the exercise of its discretion, this Covenant shall continue in effect in perpetuity.

ARTICLE VII
MISCELLANEOUS

7.01. No Dedication Intended. Nothing set forth in this Covenant shall be construed to be a gift or dedication, or offer of a gift or dedication, of the Property, or any portion thereof to the general public or anyone else for any purpose whatsoever.

7.02. Department References. All references to the Department include successor agencies/departments or other successor entity.

7.03. Recordation. The Covenantor shall record this Covenant, with all referenced Exhibits, in the County of San Francisco within ten (10) days of the Covenantor's receipt of a fully executed original.

7.04. Notices. Whenever any person gives or serves any notice ("Notice" as used herein includes any demand or other communication with respect to this Covenant), each such Notice shall be in writing and shall be deemed effective: (1) when delivered, if personally delivered to the person being served or to an officer of a corporate party being served, or (2) three (3) business days after deposit in the mail, if mailed by United States mail, postage paid, certified, return receipt requested:

To Owner:

G723986

On or Before 12/31/00:

Port of San Francisco
3100 Ferry Building
San Francisco, CA 94111
Attention: Carol Bach,

With a copy to

Noreen Ambrose
Port General Counsel
Port of San Francisco
3100 Ferry Building
San Francisco, CA 94111.

After 12/31/00:

Port of San Francisco
Pier 1
San Francisco, CA 94111
Attention: Carol Bach,

With a copy to:
Noreen Ambrose
Port General Counsel
Port of San Francisco
Pier 1
San Francisco, CA 94111.

To Department:

California Environmental Protection Agency
Department of Toxic Substances Control
700 Heinz Avenue, Suite 300
Berkeley, CA 94710-2737
Attention: Branch Chief
Standardized Permits and Corrective Action Branch

Any party may change its address or the individual to whose attention a notice is to be sent by giving written notice in compliance with this paragraph.

7.05. Partial Invalidity. If any portion of the Restrictions or other term set forth herein is determined by a court of competent jurisdiction to be invalid for any reason, the surviving portions of this Covenant shall remain in full force and effect as if such portion found invalid had not been included herein.

G723986

IN WITNESS WHEREOF, the Parties execute this Covenant.

"Covenantor"

CITY & COUNTY OF SAN FRANCISCO

Date: 1/26/2000

By: 
DOUGLAS F. WONG
Its: Executive Director
PORT OF SAN FRANCISCO

"Department"

DEPARTMENT OF TOXIC SUBSTANCES CONTROL

Date: 1/26/00

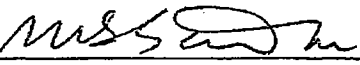
By: 
MOHINDER S. SANDHU
Its: Chief, Standardized Permits and Corrective Action
Branch

CALIFORNIA ALL-PURPOSE ACKNOWLEDGMENT

State of California

County of San Francisco } ss.

On January 26, 2000, before me, Virna C. Wu, "Notary Public"
Date Name and Title of Officer (e.g., "Jane Doe, Notary Public")

personally appeared Douglas Farrell Wong
Name(s) of Signer(s)

personally known to me
 proved to me on the basis of satisfactory evidence

to be the person(s) whose name(s) is/are subscribed to the within instrument and acknowledged to me that he/she/they executed the same in his/her/their authorized capacity(ies), and that by his/her/their signature(s) on the instrument the person(s), or the entity upon behalf of which the person(s) acted, executed the instrument.

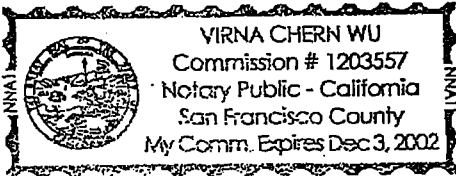

WITNESS my hand and official seal.

Virna C. Wu
Signature of Notary Public

Place Notary Seal Above

OPTIONAL

Though the information below is not required by law, it may prove valuable to persons relying on the document and could prevent fraudulent removal and reattachment of this form to another document.

Description of Attached Document

Title or Type of Document: Environmental Restriction

Document Date: 1/26/2000 Number of Pages: 8 + 6 (Parcel M, C, D)

Signer(s) Other Than Named Above: None

Capacity(ies) Claimed by Signer

Signer's Name: Douglas Farrell Wong

- Individual
- Corporate Officer — Title(s): _____
- Partner — Limited General
- Attorney in Fact
- Trustee
- Guardian or Conservator
- Other: Port Executive Director

Signer Is Representing: Port of San Francisco

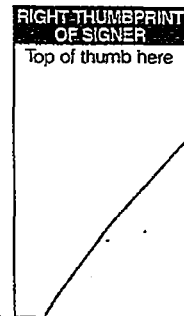

G723986

CALIFORNIA ALL-PURPOSE ACKNOWLEDGMENT

State of California }
County of San Francisco } ss.

On January 26, 2000, before me, Virna C. Wu, "Notary Public"
Date Name and Title of Officer (e.g., "Jane Doe, Notary Public")
personally appeared Mohinder Singh Sandhu
Name(s) of Signer(s)

personally known to me
 proved to me on the basis of satisfactory evidence

to be the person(s) whose name(s) is/are subscribed to the within instrument and acknowledged to me that he/she/they executed the same in his/her/their authorized capacity(ies), and that by his/her/their signature(s) on the instrument the person(s), or the entity upon behalf of which the person(s) acted, executed the instrument.

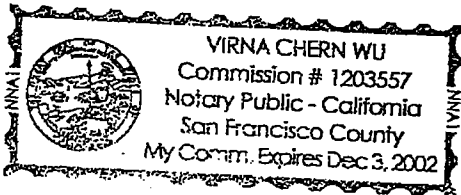

WITNESS my hand and official seal.

Virna C. Wu

Place Notary Seal Above

Signature of Notary Public

OPTIONAL

Though the information below is not required by law, it may prove valuable to persons relying on the document and could prevent fraudulent removal and reattachment of this form to another document.

Description of Attached Document

Title or Type of Document: Environmental Restriction

Document Date: 01/26/2000 Number of Pages: 8+6 (Parcel A, C, D)

Signer(s) Other Than Named Above: None

Capacity(ies) Claimed by Signer

Signer's Name: Mohinder Singh Sandhu
 Individual
 Corporate Officer — Title(s): _____
 Partner — Limited General
 Attorney in Fact
 Trustee
 Guardian or Conservator
 Other: Chief, Standardized Permits & Collective Action Branch

Signer Is Representing: Dept. of Toxic Substances Control



G723986

SEAWALL LOT 337

.PARCEL A

ALL THAT CERTAIN REAL PROPERTY SITUATED AT THE CITY AND COUNTY OF SAN FRANCISCO, BEING A PORTION OF SEAWALL LOT 337 OF THE SAN FRANCISCO PORT AUTHORITY, DESCRIBED AS FOLLOWS; COMMENCING AT THE SOUTHWEST CORNER OF THE INTERSECTION OF TOWNSEND STREET AND DELANCEY STREET (FORMERLY FIRST STREET), SAID CORNER BEING INNER 14 OF THE INNER WATERFRONT LINE AS DESCRIBED IN THE RECORDS ON FILE AT THE OFFICE OF ENGINEERING OF THE SAN FRANCISCO PORT AUTHORITY; RUNNING THENCE ALONG SAID INNER WATERFRONT LINE AT S 3DEG 02'27" E A DISTANCE OF 2,217.59 FEET TO THE TRUE POINT OF BEGINNING; THENCE CONTINUING ALONG THE LAST AFOREMENTIONED COURSE A DISTANCE OF 149.77 FEET; THENCE AT S 86DEG 57'33" W A DISTANCE OF 38.12 FEET; THENCE AT S 3DEG 14'22" E A DISTANCE OF 31.51 FEET; THENCE AT N 86DEG 45'38" E A DISTANCE OF 55.69 FEET; THENCE AT S 3DEG 02'27" E A DISTANCE OF 120.00 FEET; THENCE AT S 86DEG 45'38" W A DISTANCE OF 55.27 FEET; THENCE AT N 3DEG 14'22" W A DISTANCE OF 120.00 FEET; THENCE AT S 86DEG 45'38" W A DISTANCE OF 40.17 FEET; THENCE AT S 3DEG 14'22" E A DISTANCE OF 120.00 FEET; THENCE AT N 86DEG 45'38" E A DISTANCE OF 40.17 FEET; THENCE AT S 3DEG 14'22" E A DISTANCE OF 48.20 FEET; THENCE AT S 86DEG 57'33" W A DISTANCE OF 142.25 FEET; THENCE AT

G723986

S 86DEG 50'57" W A DISTANCE OF 111.99 FEET; THENCE AT
N 3DEG 10'55" W A DISTANCE OF 200.00 FEET; THENCE AT
N 86DEG 57'33" E A DISTANCE OF 171.00 FEET; THENCE AT
N 3DEG 02'27" W A DISTANCE OF 149.48 FEET; THENCE AT
N 86DEG 49'20" E A DISTANCE OF 121.29 FEET TO THE TRUE POINT OF
BEGINNING, CONTAINING AN AREA OF 70,765.20 SQUARE FEET, MORE
OR LESS.

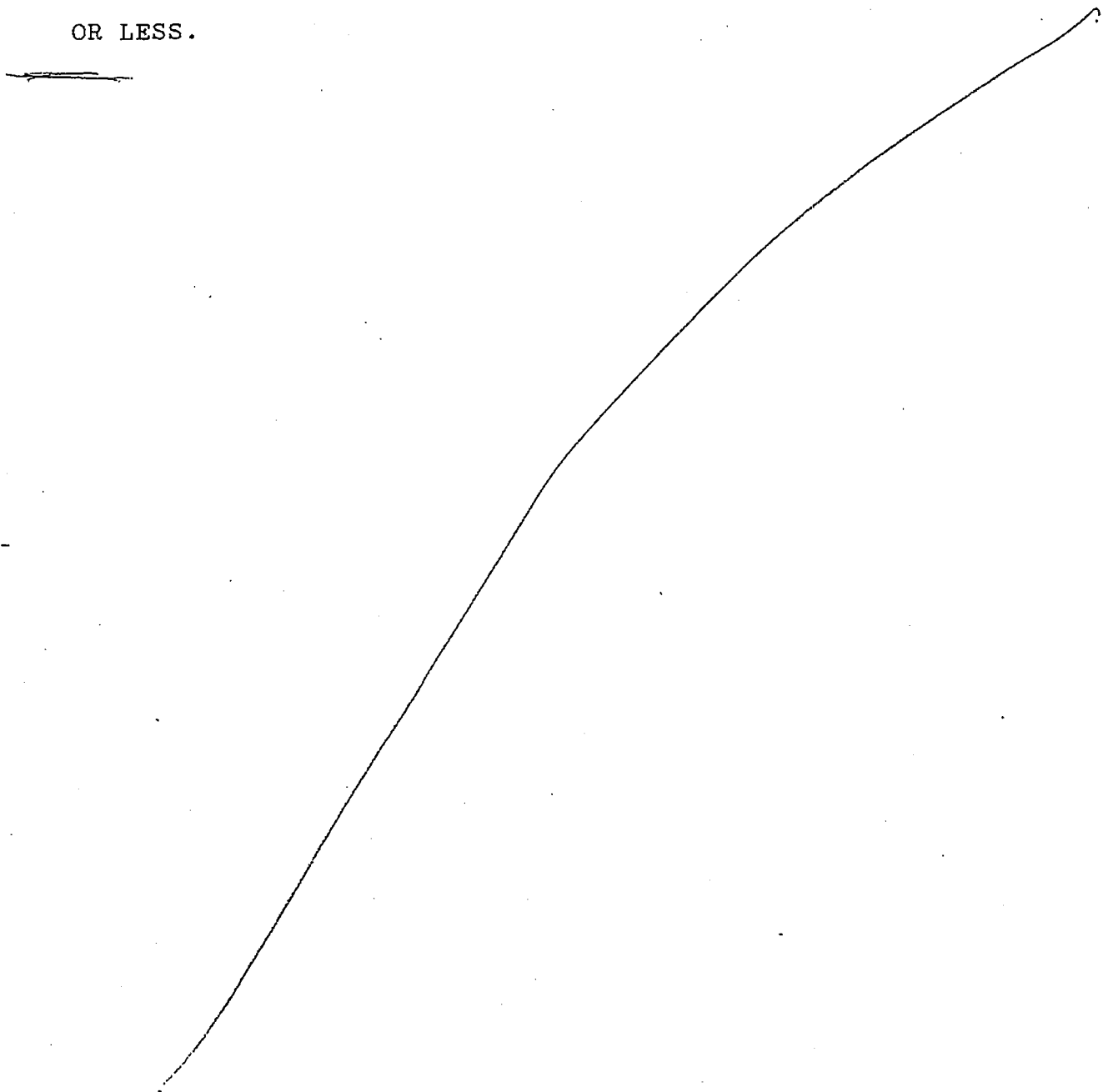

G723986

SEAWALL LOT 337

PARCEL C

BEING A PORTION OF SEAWALL LOT 337 OF THE SAN FRANCISCO PORT AUTHORITY ,CITY AND COUNTY OF SAN FRANCISCO, BRIEFLY DESCRIBED AS FOLLOWS; COMMENCING AT THE SOUTHWEST CORNER OF THE INTERSECTION OF TOWNSEND STREET AND DELANCEY STREET (FORMERLY FIRST STREET), SAID CORNER BEING INNER 14 OF THE INNER WATERFRONT LINE AS DESCRIBED IN THE RECORDS ON FILE AT THE OFFICE OF ENGINEERING OF THE SAN FRANCISCO PORT AUTHORITY; RUNNING THENCE ALONG THE AFORESAID INNER WATERFRONT LINE AT S 3DEG 02'27" E A DISTANCE OF 2,367.36 FEET TO THE TRUE POINT OF BEGINNING; THENCE AT S 48DEG 02'27" E A DISTANCE OF 25.00 FEET; THENCE AT S 3DEG 02'27" E A DISTANCE OF 13.64 FEET; THENCE AT S 86DEG 45'38" W A DISTANCE OF 55.69 FEET; THENCE AT N 3DEG 14'22" W A DISTANCE OF 31.51 FEET; THENCE AT N 86DEG 57'33" E A DISTANCE OF 38.12 FEET TO THE TRUE POINT OF BEGINNING, CONTAINING AN AREA OF 1,594.90 SQUARE FEET, MORE OR LESS.

G723986

ALSO INCLUDED IN THIS PARCEL IS A PORTION OF SEAWALL
LOT 337 BRIEFLY DESCRIBED AS FOLLOWS;
COMMENCING AT THE SOUTHWEST CORNER OF THE INTERSECTION OF
TOWNSEND STREET AND DELANCEY STREET (FORMERLY FIRST STREET)
SAID POINT BEING INNER 14 OF THE INNER WATERFRONT LINE AS
DESCRIBED IN THE RECORDS ON FILE AT THE OFFICE OF ENGINEERING
OF THE SAN FRANCISCO PORT AUTHORITY; RUNNING THENCE ALONG THE
AFORESAID INNER WATERFRONT LINE A DISTANCE OF 2,518.74 FEET;
THENCE AT N 86DEG 45'38" E A DISTANCE OF 17.66 FEET TO THE
TRUE POINT OF BEGINNING; THENCE AT S 3DEG 02'27" E DISTANCE OF
30.72 FEET; THENCE AT S 41DEG 57'33" W A DISTANCE OF 25.00
FEET; THENCE S 86DEG 57'33" W A DISTANCE OF 37.43 FEET; THENCE
AT N 3DEG 14'22" W A DISTANCE OF 48.20 FEET; THENCE AT
N 86DEG 45'38" E DISTANCE OF 55.27 FEET TO THE TRUE POINT
OF BEGINNING, CONTAINING AN AREA OF 2,509.60 SQUARE FEET, MORE
OR LESS.

G723986

SEAWALL LOT 337

PARCEL D

PARCEL D IS A TWO-STORY WAREHOUSE AND OFFICE BUILDING LOCATED AT CHINA BASIN STREET WHOSE FOOTPRINT IS BRIEFLY DESCRIBED AS FOLLOWS;

COMMENCING AT THE SOUTHWEST CORNER OF THE INTERSECTION OF TOWNSEND STREET AND DELANCEY STREET (FORMERLY FIRST STREET), SAID POINT BEING INNER 14 OF THE INNER WATERFRONT LINE AS DESCRIBED IN THE RECORDS ON FILE AT THE OFFICE OF ENGINEERING OF THE SAN FRANCISCO PORT AUTHORITY; RUNNING THENCE SOUTHERLY ALONG THE AFORESAID INNER WATERFRONT LINE AT S 3DEG 02'27" E A DISTANCE OF 2,398.74 FEET; THENCE AT N 86DEG 45'38" E A DISTANCE OF 38.02 FEET TO THE TRUE POINT OF BEGINNING; THENCE AT S 3DEG 14'22" E A DISTANCE OF 120.00 FEET; THENCE AT S 86DEG 45'38" W A DISTANCE OF 40.17 FEET; THENCE AT N 3DEG 14'22" W A DISTANCE OF 120.00 FEET; THENCE AT N 86DEG 45'38" E A DISTANCE OF 40.17 FEET TO THE TRUE POINT OF BEGINNING, CONTAINING AN AREA OF 4,820.00 SQUARE FEET, MORE OR LESS.

ALSO INCLUDED IN THIS PARCEL IS THE SECOND FLOOR OFFICE SPACE OF THE AFOREMENTIONED TWO-STORY BUILDING WITH AN AREA OF 2,414.00 SQUARE FEET, MORE OR LESS.

G723986

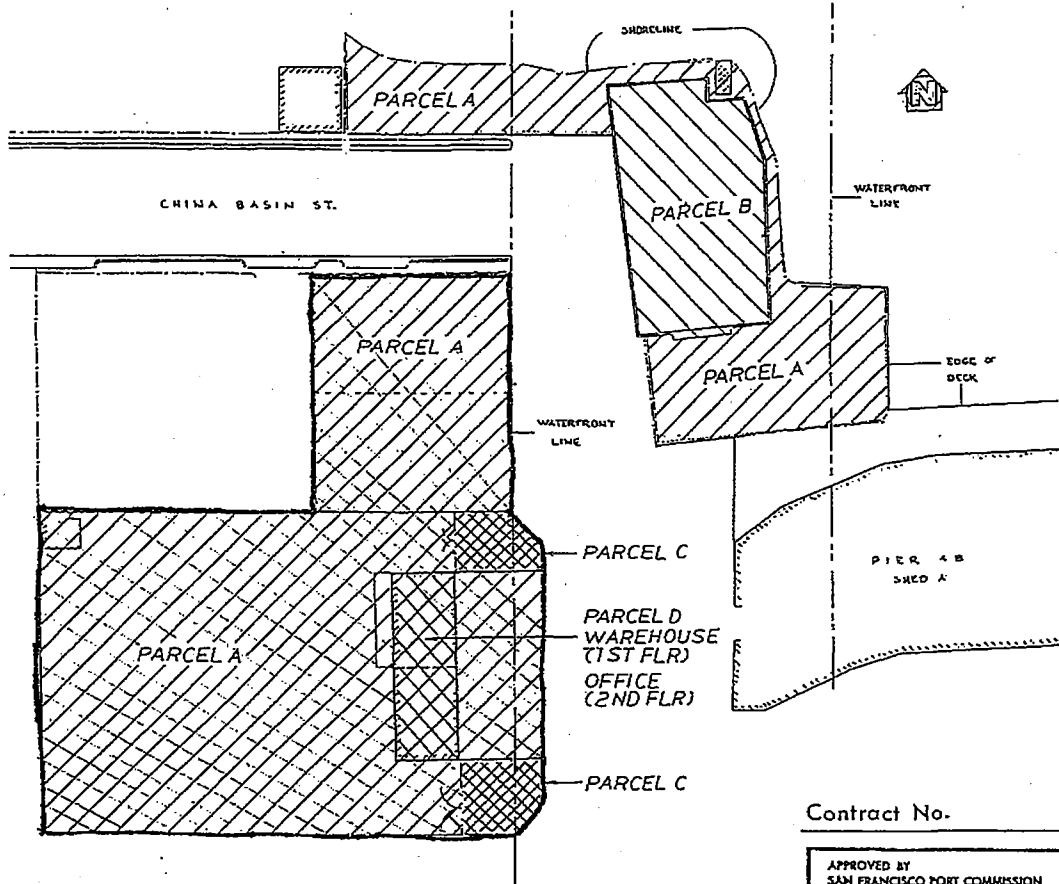

PARCEL A	91,844 SF
PARCEL B	14,071 SF
SUB-TOTAL	105,915 SF
PARCEL C	4,105 SF
PARCEL D	
WAREHOUSE	4,820 SF
OFFICE	2,414 SF
TOTAL	117,254 SF

NO.	DATE	DESCRIPTION
REVISIONS		
PORT OF SAN FRANCISCO SAN FRANCISCO PORT COMMISSION DEPARTMENT OF ENGINEERING		
EXHIBIT A-1 H & H SHIP SERVICE CO. LEASE NO. L-11679		
DRAWN BY	E.C.C.	CHECKED BY
DESIGNED BY		DATE
SECTION HEAD		SCALE
DRAWING NO.		SHEET NO.
		OF SHEETS

Contract No. _____

APPROVED BY
SAN FRANCISCO PORT COMMISSION
DATE July 21, 1992
C. J. [Signature]
CHIEF ENGINEER

APPENDIX E
Covenant to Restrict Use of Property
Recorded July 25, 2002

20020817-Wong

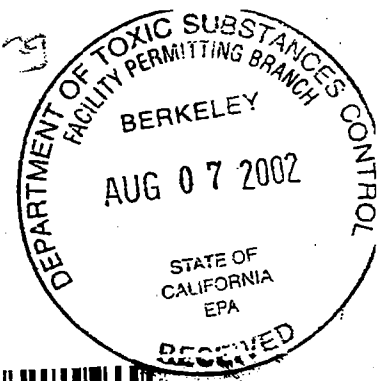

RECORDING REQUESTED BY:
The Port of San Francisco
Ferry Building
San Francisco, California 94111

WHEN RECORDED, MAIL TO

Department of Toxic Substances Control
700 Heinz Avenue, Suite 300
Berkeley, California 94710
Attention: Mohinder S. Sandhu, P.E., Chief
Standardized Permits and Corrective Action
Branch

San Francisco Assessor-Recorder
Doris M. Ward, Assessor-Recorder
DOC-2002-H209674-00

Acct 25-NO CHARGE DOCUMENT
Thursday, JUL 25, 2002 12:45:40
Ttl Pd \$0.00 Nbr-0001906468
REEL I187 IMAGE 0545
oj1/JL/1-14

SPACE ABOVE THIS LINE RESERVED FOR RECORDER'S USE

COVENANT TO RESTRICT USE OF PROPERTY
ENVIRONMENTAL RESTRICTION

*(Re: H&H Site located at China Basin Channel and Terry Francois Blvd, City and
County of San Francisco)*

This Covenant and Agreement ("Covenant") is made by and between the City and County of San Francisco, a charter city and county in trust (the "Covenantor"), the current owner of certain property situated in the City and County of San Francisco, State of California, described in Exhibit "A", attached hereto and incorporated herein by this reference (the "Property"), and the Department of Toxic Substances Control (the "Department"). Pursuant to Civil Code section 1471(c) and the California Health and Safety Code, Section 25222.1, the Department has determined that this Covenant is reasonably necessary to protect present or future human health or safety or the environment as a result of the presence on the land of hazardous materials as defined in Health and Safety Code ("H&SC"), Section 25260. The Covenantor and the Department, collectively referred to as the "Parties", therefore intend that the use of the Property be restricted as set forth in this Covenant, in order to protect human health,

safety and the environment.

ARTICLE I
STATEMENT OF FACTS

1.01. The Property, totaling approximately 0.6 acres, is more particularly described in Exhibit "A" and depicted in Exhibit "A-1", attached hereto and incorporated herein by this reference. The Property is located in the area now generally bounded by Terry Francois Boulevard to the west, China Basin Channel to the north, and San Francisco Bay to the east, in the City and County of San Francisco, California.

1.02. The site was created by filling marshlands and shallow tidal flats bordering San Francisco Bay between 1877 and 1913. Sources of fill are unknown, but likely included construction/demolition debris and rubble, and rock and dirt cut from nearby hills. Historical uses of the Site include railroad tracks and related support structures and parking. From 1950 to 1996 H&H Ship Service occupied the area for wastewater treatment and transfer operations, including aboveground storage tanks for receiving, settling and treating wastewater containing petroleum.

In 1978 several of the wastes managed at the H&H Ship Service facility were determined to be hazardous wastes subject to federal and state hazardous waste management regulations. Since that time, the Department of Toxic Substances Control (or its predecessor in interest, the Department of Health Services) authorized H&H Ship Service's operations pursuant to an interim status document. Under this authorization the property was a hazardous waste facility (Facility), regulated by the Department, subject to the requirements of the California Hazardous Waste Control Law ("HWCL"), at Health and Safety Code ("H&S Code") section 25100 et seq., and the federal Resource Conservation and Recovery Act ("RCRA"), at 42 U.S.C. section 6901 et seq. Under Interim Status, the property was a portion of the Facility that was known as the Treatment/Transfer Area (TTA).

The Department is requiring this Covenant pursuant to the closure requirements of the HWCL, including H&S Code section 25246 and post-closure notices provisions of Title 22 California Code of Regulations [section 66265.119(b) for interim status hazardous waste facilities], as part of the facility closure. In 1994, the Department reviewed H&H's Closure Plan to ensure that the closure of the TTA met the requirements in Title 22, California Code of Regulations, Chapter 15, Article 7. The Department circulated the draft Closure Plan and Proposed Negative Declaration for public review and comment from August 11, 1994 to September 13, 1994. The Department approved the Closure Plan on January 13, 1995 and filed a Notice of Determination for the project with the

State Clearinghouse on February 15, 1995.

The Department reviewed the closure certification report titled, *RCRA Closure Certification Report, Former H&H Ship Service Facility, San Francisco, California*, (February 4, 1999), and subsequent submittals titled *Response to Comments, RCRA Closure Certification Report, Former H&H Ship Service Facility*, (November 2, 1999); *Results of Article 20 Sampling Program. Proposed China Basin Park Area* (July 2000); *Site Investigation and Surface Soil Sampling Results, Former H&H Ship Service Company – Treatment Transfer Area Parcel* (February 28, 2002); and *Addendum to the Article 20 Health Risk Assessment* (July 18, 2002). Upon filing of this deed restriction, the Department will approve the closure certification report.

Hazardous wastes, which are also hazardous materials as defined in Health and Safety Code sections 25117 and 25260, including petroleum hydrocarbons, polynuclear aromatic hydrocarbons, metals and arsenic, remain in the soil and groundwater at the Site at concentrations below those which would pose a significant human health risk under proposed reuse scenarios. Therefore a deed restriction to limit use of the property to those exposure scenarios evaluated and found to be below acceptable risk limits is required as part of the facility closure.

1.03. As detailed in the above-referenced reports, portions of the surface and subsurface soils on the Site contain hazardous wastes and hazardous materials, as defined in H&S Code section 25117 and 25260, including the following contaminants of concern: arsenic (up to 96 mg/kg) and benzo(a)pyrene (up to 11 mg/kg). Groundwater beneath the Property is found within 10 to 20 feet below ground surface. Dissolved arsenic was found in groundwater at up to 180 ug/l. The California drinking water standard for arsenic is 50 ug/l.

A review of the analytical results and the chemical distribution suggests that there are "hot spots". Hot spots are areas of affected soil or groundwater having concentrations higher than an empirically determined percentile of the distribution of concentrations in a particular population. 65 soil samples from 20 locations at various depths were collected within the TTA. Elevated concentrations of benzo(a)pyrene equivalent B(a)P EQ were measured in samples collected from two borings locations (EB-1, 19.8 milligrams per kilogram [mg/kg]) and (EB-20, 7.9 mg/kg). One surface soil sample (GMX-08) contained B(a)P EQ concentration of 1.5 mg/kg. All other concentrations of B(a)P EQ were less than 1 mg/kg. Elevated concentrations of arsenic and lead were observed in samples collected from borings EB-1 (3,000 mg/kg lead), EB-5 (96 mg/kg arsenic and 1,300 mg/kg lead), and EB-18 (2,400 mg/kg lead). Borings EB-1 and EB-5 are located in the eastern section of the TTA; GMX-08 is located near the northern perimeter; and borings EB-18 and EB-20 are located in the southwest section.

Based on these observations, borings EB-1, EB-5, GMX-08, EB-18, and EB-20 can be considered hot spots. However, each of borings is located under a concrete/asphalt

foundation or a compacted aggregate/crushed rock/roadbase material. The concrete/asphalt foundation or compacted aggregate/crushed rock/roadbase material serves as a physical barrier preventing direct contact with chemicals in soil; thus, there are no potential direct exposure pathways to chemicals at these hot spots by future receptors. If in the unlikely event that the concrete/asphalt foundation is removed, the excess cancer risk to a receptor from the hot spots would range from 9×10^{-5} to 3×10^{-6} .

Imported topsoil at least 18 inches thick followed by a layer of sod will be placed over the existing asphalt-concrete foundation. The concrete is present at one foot thick to at least 3 feet thick across approximately two-third of the TTA. The remaining one-third of the TTA is currently overlain with an aggregate/crushed rock/roadbase material. The concrete/asphalt foundation and compacted aggregate/crushed rock/roadbase layer precludes a complete exposure pathway. Additional of the 18 inches of topsoil and sod layer will eliminate potential direct exposures to soil in fill material within the TTA.

In order to ensure that no complete pathways are established, the Department will require that the existing concrete/asphalt foundation remain undisturbed so long as the intended use of the Property is to be a recreational park. Additionally, the Department will require that the site be covered (capped) with at least eighteen (18) inches of imported topsoil on top of an indicator lining material to denote the separation of the topsoil from native fill. Because the health risk assessment also did not evaluate an unrestricted land use scenario or potential impacts from use of groundwater, the Department concluded that use of the Property as a residence, hospital, school for persons under the age of 21, or day care center would entail an unacceptable use. The Department further concluded that the Property, subject to the restrictions of this Covenant, does not present an unacceptable threat to human safety or the environment.

ARTICLE II DEFINITIONS

2.01. Department. "Department" shall mean the California Department of Toxic Substances Control and shall include its successor agencies, if any.

2.02. Owner. "Owner" shall mean the Covenantor, its successors in interest, and their successors in interest, including heirs and assigns, who at any time hold title to all or any portion of the Property.

2.03. Occupant. "Occupant" shall mean Owners and any person or entity entitled by ownership, leasehold, or other legal relationship to the right to occupy any portion of the Property.

2.04. Cap. "Cap" shall mean eighteen (18) inches of imported topsoil on top of

an indicator lining material which is used to denote the separation of the imported topsoil from native fill.

2.05 Concrete/Asphalt Foundation. "Concrete/Asphalt Foundation" shall mean the existing concrete/asphalt surface which is overlain approximately two-third of the Property.

2.03. ARTICLE III GENERAL PROVISIONS

3.01. Restrictions to Run With the Land. This Covenant sets forth protective provisions, covenants, restrictions, and conditions (collectively referred to as "Restrictions"), upon and subject to which the Property and every portion thereof shall be improved, held, used, occupied, leased, sold, hypothecated, encumbered, and/or conveyed. Each and every one of the Restrictions: (a) shall run with the land pursuant to H&SC sections 25202.5, and 25202.6 and Civil Code section 1471; (b) shall inure to the benefit of and pass with each and every portion of the Property, (c) shall apply to and bind the respective successors in interest to the Property, (d) are for the benefit of, and shall be enforceable by the Department, and (e) are imposed upon the entire Property unless expressly stated as applicable only to a specific portion thereof.

3.02. Binding Upon Owners/Occupants. Pursuant to Health and Safety Code section 25202.5(b), this Covenant shall be binding upon all of the owners of the land, their heirs, successors, and assignees, and the agents, employees, and lessees of the owners, heirs, successors, and assignees. Pursuant to Civil Code section 1471(b), all successive owners of the Property are expressly bound hereby for the benefit of the covenantee(s) herein. "Owner" shall include "Covenantor".

3.03. Written Notice of Hazardous Substance Release. The Owner shall, prior to the sale, lease, or rental of the Property, give written notice that a release of hazardous substances has come to be located on or beneath the Property, pursuant to Health and Safety Code section 25359.7. Such written notice shall include a copy of this Covenant.

3.04. Incorporation into Deeds and Leases. The Restrictions set forth herein shall be incorporated by reference in each and all deeds and leases for any portion of the Property.

3.05. Conveyance of Property. Covenantor agrees that the Owner shall provide notice to the Department not later than thirty (30) days after any conveyance of any ownership interest in the Property (excluding mortgages, liens, and other non-possessory encumbrances). The Department shall not, by reason of this Covenant, have authority to approve, disapprove, or otherwise affect such proposed conveyance, except as otherwise provided by law, by administrative order, or specific provision of this Covenant.

ARTICLE IV
RESTRICTIONS

4.01. Prohibited Uses. The Property shall not be used for any of the following purposes:

- (a) A residence, including any mobile home or factory built housing, constructed or installed for use as residential human habitation;
- (b) A public or private school for persons under 21 years of age; or
- (c) A hospital for humans; or
- (c) A day care center for children.

4.02 Prohibited Activities. The following activities shall not be conducted at the Property:

- (a) No raising of food (e.g., cattle, food crops, cotton, etc.) shall be permitted on the property.
- (b) No groundwater shall be extracted on the Property for purposes other than site remediation or construction dewatering without prior written approval by the Department.

4.03 Non-Interference with the Cap. Covenantor agrees:

- (a) No activities which will disturb the Cap (e.g. excavation, grading, removal, trenching, filling, earth movement, or mining) shall be permitted on the Property without prior review and approval by the Department.
- (b) All uses and development of the Property shall preserve the integrity of the Cap.
- (c) Any proposed alteration of the Cap shall require written approval by the Department.
- (d) Covenantor shall notify the Department of each of the following: (i) The type, cause, location and date of any disturbance to the Cap which could affect the ability of the Cap to contain subsurface hazardous materials in the Property, and (ii) the type and date of repair of such disturbance. Notification to the Department shall be made as provided below within ten (10) working days of both the discovery of any such disturbance(s) and the completion of any repairs. Timely and accurate notification by any Owner or Occupant shall satisfy this requirement on behalf of all other

Owners and Occupants.

4.04. Management of Native Fill and Concrete/Asphalt Foundation Material

- (a) All uses and development of the Property shall preserve the integrity of the existing Concrete/Asphalt Foundation.
- (b) No activities (e.g., excavation, grading, removal, trenching, filling, earth movement or mining) which will disturb the native fill and/or the Concrete/Asphalt Foundation material underlying the Cap as indicated in Exhibit B shall be permitted on the Property without a Department-approved Soil Management Plan and Health and Safety Plan.
- (c) Native fill and/or Concrete/Asphalt Foundation material shall not be managed or handled such that it may migrate into the bay.
- (d) Any native fill and/or Concrete/Asphalt Foundation material brought to the surface by grading, excavation, trenching or backfilling shall be managed in accordance with the applicable state and federal laws and their implementing regulations.
- (e) The Owner shall provide the Department written notice at least fourteen (14) days prior to any building, filling, grading, mining or excavating at the Property.
- (f) If more than 50 cubic yards of any native fill will be disturbed, including excavation and grading, then the soil shall be evaluated for potential human health risks in compliance with Article 20 of the SF Municipal Code ("the Maher Ordinance"), and managed accordingly.
- (g) Covenantor shall notify the Department of each of the following: (i) The type, cause, location and date of any disturbance to the native fill and/or Concrete/Asphalt Foundation which could affect the ability of the Concrete/Asphalt Foundation to contain subsurface hazardous materials in the Property, and (ii) the type and date of repair of such disturbance. Notification to the Department shall be made as provided below within ten (10) working days of both the discovery of any such disturbance(s) and the completion of any repairs. Timely and accurate notification by any Owner or Occupant shall satisfy this requirement on behalf of all other Owners and Occupants.

4.05. Access for Department. Covenantor agrees that the Department shall

have reasonable right of entry and access to the Property for inspection, monitoring, and other activities consistent with the purposes of this Covenant as deemed necessary by the Department in order to protect the public health and safety.

ARTICLE V
ENFORCEMENT

5.01. Enforcement. Failure of the Covenantor and/or Owner to comply with any of the Restrictions specifically applicable to it shall be grounds for the Department, by reason of this Covenant, to require that the Covenantor and/or Owner modify or remove any improvements ("Improvements" herein shall mean all buildings, roads, driveways, and paved parking areas, constructed or placed upon any portion of the Property constructed in violation of the Restrictions.) Violation of this Covenant shall be grounds for the Department to file civil and/or criminal actions against the Covenantor and/or Owner as provided by law.

ARTICLE VI
VARIANCE, TERMINATION, AND TERM

6.01. Variance. Any Owner or, with the Owner's written consent, any Occupant of the Property or any portion thereof may apply to the Department for a written variance from the provisions of this Covenant. Such application shall be made in accordance with H&S Code section 25202.6.

6.02. Termination. Any Owner, and/or, with the Owner's written consent, any Occupant of the Property, or any portion thereof, may apply to the Department for a termination of the Restrictions or other terms of this Covenant as they apply to all or any portion of the Property. Such application shall be made in accordance with H&S Code section 25202.6.

6.03. Term. Unless ended in accordance with the Termination Paragraph above, by law, or by the Department in the exercise of its discretion, this Covenant shall continue in effect in perpetuity.

ARTICLE VII
MISCELLANEOUS

7.01. No Dedication Intended. Nothing set forth in this Covenant shall be construed to be a gift or dedication, or offer of a gift or dedication, of the Property, or any portion thereof to the general public or anyone else for any purpose whatsoever.

7.02. Department References. All references to the Department include successor agencies/departments or other successor entity.

7.03. Recordation. The Covenantor shall record this Covenant, with all referenced Exhibits, in the County of San Francisco within ten (10) days of the Covenantor's receipt of a fully executed original.

7.04. Notices. Whenever any person gives or serves any notice ("Notice" as used herein includes any demand or other communication with respect to this Covenant), each such Notice shall be in writing and shall be deemed effective: (1) when delivered, if personally delivered to the person being served or to an officer of a corporate party being served, or (2) three (3) business days after deposit in the mail, if mailed by United States mail, postage paid, certified, return receipt requested:

To Owner:

Carol Bach
Assist. Deputy Director, Environmental Health and Safety
Port of San Francisco
Pier 1
San Francisco, CA 94111

With a copy to:

Noreen Ambrose
Port General Counsel
Port of San Francisco
Pier 1
San Francisco, CA 94111.

To Department:

California Environmental Protection Agency
Department of Toxic Substances Control
700 Heinz Avenue, Suite 300
Berkeley, CA 94710-2737
Attention: Chief, Standardized Permits and Corrective Action
Branch

Any party may change its address or the individual to whose attention a notice is to be sent by giving written notice in compliance with this paragraph.

7.05. Partial Invalidity. If any portion of the Restrictions or other term set forth herein is determined by a court of competent jurisdiction to be invalid for any reason, the surviving portions of this Covenant shall remain in full force and effect as if such portion found invalid had not been included herein.

H209674

IN WITNESS WHEREOF, the Parties execute this Covenant.

"Covenantor"

Date: 7/24/02

By: //original signed by//
DOUGLAS F. WONG
Its: Executive Director

"Department"

Date: 7/24/02

By: //original signed by//
Mohinder S. Sandhu, P.E.
Its: Chief, Standardized Permits and Corrective Action
Branch

CALIFORNIA ALL-PURPOSE ACKNOWLEDGMENT

State of California

County of San Francisco } ss.

On July 24, 2002 before me, Virna C. Wu "Notary Public"
Date Name and Title of Officer (e.g., "Jane Doe, Notary Public")

personally appeared Mohinder Singh Sandhu
Name(s) of Signer(s)

- personally known to me.
- ~~proved to me on the basis of satisfactory evidence~~

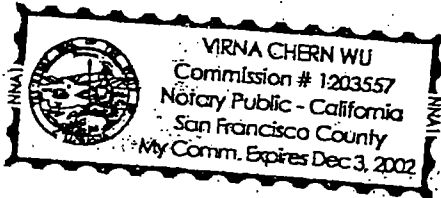

to be the person(s) whose name(s) is/are subscribed to the within instrument and acknowledged to me that he/~~she~~/they executed the same in his/her/their authorized capacity(~~ies~~), and that by his/~~her~~/their signature(s) on the instrument the person(s), or the entity upon behalf of which the person(s) acted, executed the instrument.

WITNESS my hand and official seal.

//original signed by//
Signature of Notary Public

Place Notary Seal Above

OPTIONAL

Though the information below is not required by law, it may prove valuable to persons relying on the document and could prevent fraudulent removal and reattachment of this form to another document.

Description of Attached Document

Title or Type of Document: Covenant to Restrict Use of Property

Document Date: None Number of Pages: 10 Pages + Exhibits A & B

Signer(s) Other Than Named Above: None

Capacity(ies) Claimed by Signer

- Signer's Name: Mohinder Singh Sandhu
- Individual
 - Corporate Officer — Title(s): _____
 - Partner — Limited General
 - Attorney in Fact
 - Trustee
 - Guardian or Conservator
 - Other: Port Executive Director

Signer Is Representing: Port of San Francisco



CALIFORNIA ALL-PURPOSE ACKNOWLEDGMENT

State of California }
County of San Francisco } ss.

On July 24, 2002 before me, Virna C. Wu "Notary Public"
Date Name and Title of Officer (e.g., "Jane Doe, Notary Public")

personally appeared Mohinder Singh Sandhu
Name(s) of Signer(s)

- personally known to me
- proved to me on the basis of satisfactory evidence

to be the person(s) whose name(s) is/are subscribed to the within instrument and acknowledged to me that he/she/they executed the same in his/hers/their authorized capacity(ies), and that by his/hers/their signature(s) on the instrument the person(s), or the entity upon behalf of which the person(s) acted, executed the instrument.

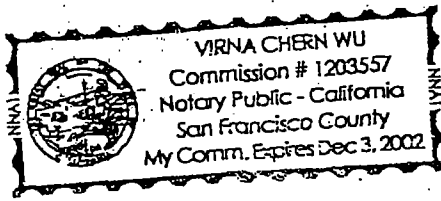

WITNESS my hand and official seal.

//original signed by//
Signature of Notary Public

Place Notary Seal Above

OPTIONAL

Though the information below is not required by law, it may prove valuable to persons relying on the document and could prevent fraudulent removal and reattachment of this form to another document.

Description of Attached Document
Title or Type of Document: Covenant to Restrict Use of Property
Environmental Restriction
Document Date: None Number of Pages: 10 Pages + Exhibits A & B
Signer(s) Other Than Named Above: None

Capacity(ies) Claimed by Signer
Signer's Name: Mohinder Singh Sandhu
 Individual
 Corporate Officer — Title(s): _____
 Partner — Limited General
 Attorney in Fact
 Trustee
 Guardian or Conservator
 Other: Chief, Standardized Permits & Corrective Action Branch
Signer Is Representing: Department of Toxic Substances Control

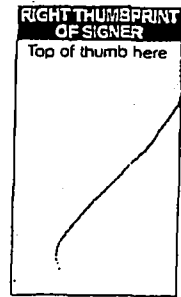
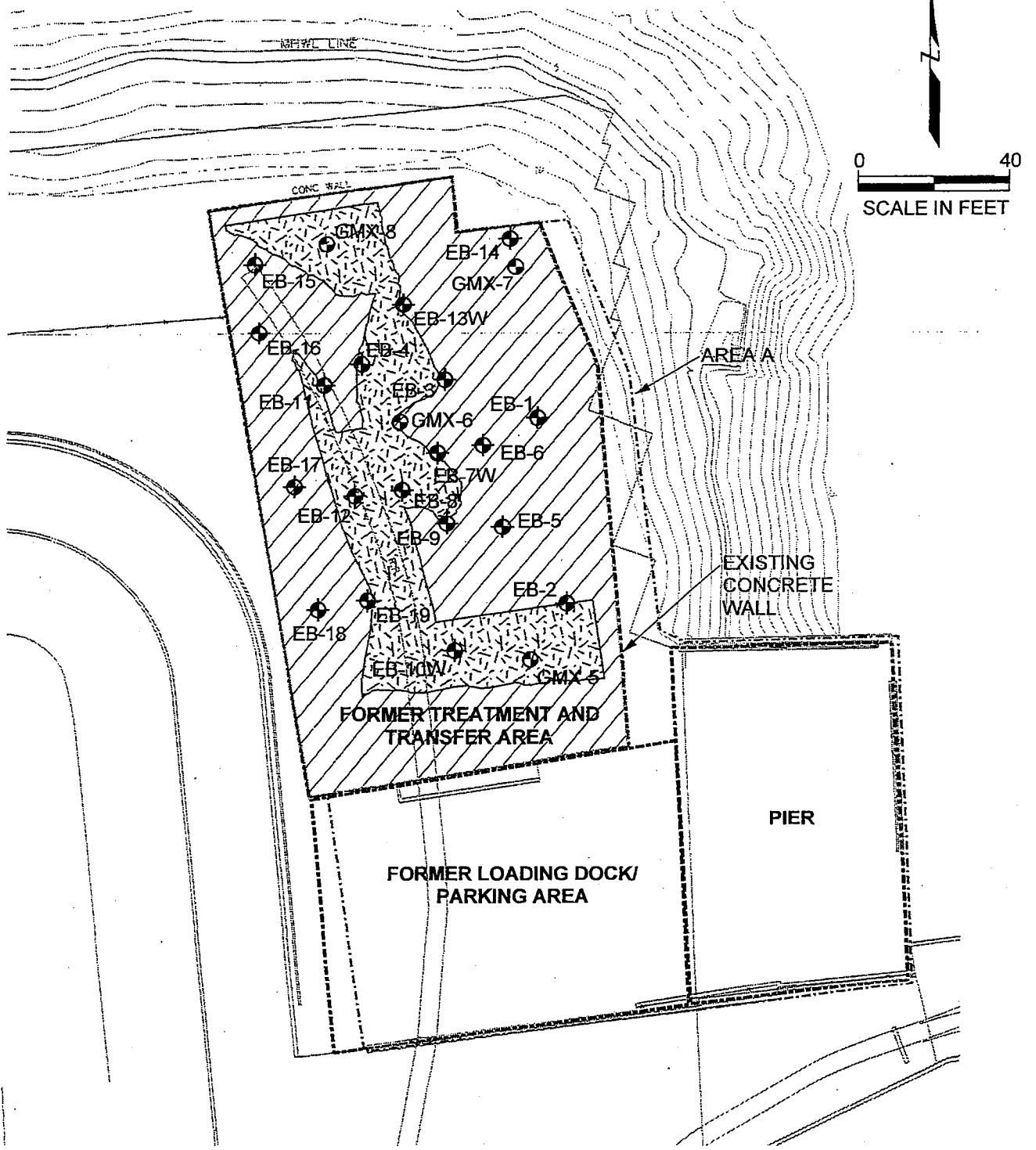

EXHIBIT A

H&H Parcel – Tank Treatment Area

All that certain real property of the San Francisco Port Commission, City and County of San Francisco, State of California, situate at the northeast corner of Terry A. Francois Boulevard (formerly China Basin Street), more particularly described as follows:

Commencing at the point of intersection of the northwesterly line of Townsend Street with the southwesterly line of Delancey Street (formerly First Street), said point being Inner 14 of the Inner Waterfront Line as described in records on file in the office of Engineering of said San Francisco Port Commission; Thence along said Inner Waterfront Line, S 03°02'27" E a distance of 2132.11 feet; Thence N 86°51'14" E a distance of 65.28 feet, to the True Point Of Beginning; Thence S 10°21'36" E a distance of 127.93 feet; Thence N 80°50'39" E a distance of 4.70 feet; Thence S 09°13'14" E a distance of 68.59 feet; Thence N 81°09'11" E a distance of 146.17 feet; Thence N 03°21'24" W a distance of 85.74 feet; Thence S 88°44'14" W a distance of 54.91 feet; Thence N 66°55'27" W a distance of 9.19 feet; Thence N 07°12'31" W a distance of 68.86 feet; Thence N 21°58'29" W a distance of 44.82 feet; Thence S 83°22'07" W a distance of 28.09 feet; Thence N 05°44'30" W a distance of 14.69 feet; Thence S 81°59'17" W a distance of 65.99 feet; Thence S 10°21'36" E a distance of 30.22 feet to the True Point Of Beginning; Containing 26,592 square feet (0.61 acres), more or less.



EXPLANATION

- ⊕ Soil samples collected at multiple depths by J. Yang and Assoc. March 15, 1995
- ⊙ Surface soil samples collected by Geomatrix, November 16, 2001

-  Area of aggregate/crushed rock/road base material
-  Concrete/asphalt foundation

EXHIBIT B

APPENDIX F
Preliminary Geotechnical Recommendations and Summary
Memorandum No. 1
(Langan Treadwell & Rollo - January 26, 2016)

555 Montgomery Street, Suite 1300 San Francisco, CA 94111 T: 415.955.5200 F: 415.955.5201

To: Ms. Fran Weld – San Francisco Giants
Mr. Jon Knorpp – San Francisco Giants

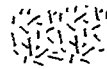
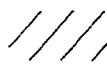
From: Cary E. Ronan, GE 2741
Lori A. Simpson, GE 2396

cc: Mr. Gerry Tierney – Perkins + Will Architects
Mr. Marc Press – KPFF Structural Engineers
Mr. Darin Peterson – Hathaway Dinwiddie General Contractors
Mr. Joe Olla – Nibbi Brothers

Date: 26 January 2016

PROJECT: Mission Rock Development
Seawall Lot 337
San Francisco, California
Langan Project No. 750604203

Subject: Preliminary Geotechnical Recommendations and
Summary Memorandum No. 1

This memorandum is in fulfillment of our proposal dated 20 January 2016. It presents preliminary geotechnical design recommendations and a summary of geotechnical issues and concepts regarding development at SWL337 that have not been formally memorialized, in addition to an overview summary of some geotechnical issues that have been discussed in the previously published documents listed above. The topics addressed in this memorandum include:

- 1) axial capacity of piles bearing above bedrock, including friction-only piles in clay and friction plus end-bearing piles bearing in dense sand
- 2) impacts of raising site and surrounding street grades, including settlement and downdrag, and measures to mitigate adverse impacts, including discussion of surcharge/wick drains, Geofoam, ground improvement/deep soil mixing beneath streets, and pile-supported streets
- 3) preliminary geotechnical recommendations for design of the Mission Rock Square garage (MRSG)
- 4) liquefaction mitigation considerations, including discussion of deep dynamic compaction (DDC), compaction grouting, rapid impact compaction (RIC), and stone columns

We have previously studied the Mission Rock development site by performing: 1) a preliminary geotechnical investigation at Seawall Lot 337 (SWL337), 2) a liquefaction and lateral spreading evaluation for SWL337 and Pier 48 shoreline, and 3) a geotechnical evaluation of the shoreline conditions at Pier 48. The results of these evaluations were presented in reports dated 8 September 2011, 23 December 2013, and 5 March 2014 (draft), respectively.

MEMO

PROPOSED DEVELOPMENT

Plans for the SWL337 site, which is bound by Terry A. Francois Boulevard on the north and east, Third Street on the west, and Mission Rock Street on the south, include constructing 12 structures between 90 and 240 feet in height (Blocks A through K, mixed residential and commercial), a large open park in the central portion of the site (Mission Rock Square), another large open park at the northern portion of the site (China Basin Park), a three-level, below-grade parking garage beneath Mission Rock Square (MRSG), and associated infrastructure, including streets, sidewalks, and utilities, as shown on Figure 1. We understand site grades will be raised to accommodate future sea level rise; the high point will be at the middle of the site at Mission Rock Square and may be about four to six feet above existing and surrounding Third Street and Terry Francois Boulevard grades. We further understand up to 1-1/2 and 4-1/2 feet of fill was placed recently (since 1997) to raise grades along the southern approximately 750 to 800 feet of Third Street adjacent to SWL337 and Mission Rock Street, respectively, and no new fill is planned along either of these streets or along Terry Francois Boulevard. On the basis of a review of drawings by Perkins + Will (Option 1 – Channel Street/Channel Plaza Entry/Exit Ramp Plan, dated 17 December 2013), it appears the lowest finished floor of the garage will be approximately 30 feet below the proposed finished grade of Mission Rock Square Park. Pier 48 will also be upgraded and be part of the Mission Rock Development.

SUBSURFACE CONDITIONS

Originally, the site was below water in a shallow bay known as Mission Bay. Starting in the 1880s, the bay was reclaimed by placing fill. Based on historic maps, we believe the majority of the site was reclaimed between 1880 and 1906. Some of the material used to reclaim the site is likely building rubble and debris from the 1906 San Francisco earthquake.

Boring logs from investigations of the site and the site vicinity indicate the site is underlain by approximately 13 to 37 feet of heterogeneous fill which varies in density and, in some areas, contains rubble comprised of brick, rock and debris. The fill is underlain by approximately 46 to 72 feet of weak, soft to medium stiff, compressible clay, locally referred to as Bay Mud. Where tested, the Bay Mud at the site appears to be slightly overconsolidated, which indicates that settlement of the Bay Mud is complete under the weight of existing fill. The deeper fill material (below a depth of about 20 to 25 feet) adjacent to thin fill (thinner than about 15 feet) is indicative of a "Bay Mud wave". A Bay Mud wave can occur when heavy fill loads are placed on the Bay Mud and cause a bearing capacity failure of the Bay Mud. As the Bay Mud fails, the gravel sinks into the soil and the Bay Mud pushes up around the failure zone, causing the thick and thin fill soil profile. The Bay Mud wave fill material encountered at this site is generally comprised of clayey gravel and gravelly clay.

The borings drilled at the site indicate the Bay Mud is generally underlain by an older marine clay, known as Old Bay Clay that is 68 to 74 feet thick where explored. Old Bay Clay is typically stiff to very stiff and overconsolidated. In one area of the site, a 28-foot-thick layer of dense to

MEMO

very dense clayey sand was encountered below the Bay Mud, which was, in turn, underlain by Old Bay Clay. Sand may be present beneath the Bay Mud in other unexplored areas of the site, as well.

Alluvial sand and clay layers are typically encountered below the Old Bay Clay. Dense to very dense sand layers with varying fines contents are present below the Old Bay Clay in some of the borings around the site. The top of this sand layer was encountered at approximately 165 to 180 feet below the existing ground surface and, where present, the sand is about 10 to 15 feet thick near the project site. Based on available borings this sand layer is not present across the entire site and, where present, varies in thickness, fines content, and density.

The top of the bedrock surface has been encountered in borings around the site at depths of about 160 feet (near the northwest corner of the site) to 260 feet (in the northeast corner of the site) below the ground surface. The bedrock surface appears to be steeply sloping down from west to east in the northern portion of the site and more gently sloping up along the eastern side of the site from a depth of 260 feet at the northeast corner to 220 feet at the southeast corner. The bedrock surface and quality are expected to vary significantly across the site.

Groundwater was encountered at the site and in the site vicinity approximately 7 to 9 feet below the existing ground surface (bgs), corresponding to approximate Elevations 91 to 93 feet¹, but has been found within five feet of the ground surface at some sites in Mission Bay. No springs or seepages were observed on site.

AXIAL PILE CAPACITY FOR PILES BEARING ABOVE BEDROCK

We provided estimates of axial and lateral capacities of 14-inch steel H-piles driven to bedrock in our preliminary geotechnical investigation report, dated 8 September 2011. Since then, the design team has requested preliminary axial capacities for piles bearing above bedrock, i.e. friction-only piles in clay and friction plus end-bearing piles bearing in dense sand. Preliminary pile capacities for all of these cases are presented below.

End-Bearing Piles

Piles can typically encounter refusal in very dense, relatively clean sand layers (typically less than 10 percent fines, passing the No. 200 sieve), at least 10 feet thick. If significant fines are present, the pile will generally continue driving through the layer. Although some borings encountered a relatively dense sand at depth, a continuous sand layer does not appear to be present across the site. However, as described in the subsurface section above, there may be

¹ Elevations reference Mission Bay datum, which is based on San Francisco City datum (SFCD) plus 100 feet.

MEMO

a dense, end-bearing sand layer present below the Bay Mud in a few areas of the site; it should be noted that this condition is not typical across Mission Bay sites. Additionally, dense sand may be present below the Old Bay Clay in some areas of the site. The capacities provided in our preliminary report are for piles with downdrag loads on them. We have been requested to provide capacities of piles without downdrag loads imposed on them. For completeness, we are including end-bearing pile capacities for piles bearing in dense sand or bedrock for driven 14-inch steel H-piles or 14-inch-square precast prestressed concrete piles with no downdrag in Table 1.

TABLE 1
Preliminary Estimated Single Pile Axial Capacity
End-Bearing Driven 14-Inch Steel H-Piles or 14-Inch-Square Precast Prestressed Concrete Piles (No Downdrag)

Estimated Pile Tip Elevation (feet, SFCD + 100 feet)	Anticipated End-Bearing Condition	$Q_{ultimate}$ Axial Capacity (kips)	$Q_{allowable}$ Dead plus Live (kips)	$Q_{allowable}$ Total Design Load (kips)
Average of -150	Bedrock	960	480	640
30 (representative of conditions in the vicinity of Boring BSWL337-2)	Dense Sand just below Bay Mud	500	175	230
-60	Dense Sand below Old Bay Clay	860	430	570

Notes:

- 1) Capacities of piles presented in Table 1 represent the capacity of the soil and bedrock only; the structural capacity of the pile should be checked and should govern if less.
- 2) For the bedrock and deeper sand (tip at Elevation -60 feet) end-bearing piles, $Q_{allowable}$ includes a factor of safety of 2 (these capacities are based on nearby pile load tests).
- 3) $Q_{allowable}$ for the shallower sand end-bearing piles (tip at Elevation 30 feet), dead plus live loads represents a factor of safety of 2 for friction and 3 for end-bearing.
- 4) $Q_{allowable}$ for total design loads (including earthquake loads) represents a 1/3 increase over $Q_{allowable}$ for dead plus live loads.

Friction-Only Piles Bearing in Clay

We developed preliminary friction-only capacity for piles extending below the Bay Mud and gaining friction in the sand and clay below the Bay Mud; these capacities are presented on Figure 2. The capacities shown on Figure 2 consider:

- capacity starting at the bottom of the Bay Mud (see Figure 1 for estimated contours of the bottom of Bay Mud elevations)
- piles do not gain capacity in the fill and Bay Mud
- a factor of safety of 2

IMPACTS OF RAISING SITE AND SURROUNDING STREET GRADES

As previously described, site grades will be raised to accommodate future sea level rise; the high point will be at the middle of the site at Mission Rock Square and may be about four to six feet above surrounding Third Street and Terry Francois Boulevard grades. We further understand up to 1-1/2 and 4-1/2 feet of fill was recently placed to raise grades along the southern portion of Third Street and Mission Rock Street, respectively, and no additional fill is planned along either of these streets or along Terry Francois Boulevard.

Using soil fill to raise grades will create a new cycle of consolidation settlement of the Bay Mud beneath the site, causing ground settlement of up to several feet. This settlement will create differential settlement between pile-supported buildings, where there will be little to no settlement, and surrounding streets, sidewalks, and other improvements. The differential settlement will affect utility connections and building entrances. The settlement will also cause an additional load (downdrag) to act on piles on the order of 200 to 225 kips, as the fill and Bay Mud move downward relative to the pile, thus reducing the pile capacity.

Where site grades have been raised in the public right-of-way around the site, the design team will need to accommodate the effects of settlement. Within the site, however, there are a variety of ways the site grades can be raised. The design team has explored several alternatives to adding soil fill loads to the site, including:

- preloading the site with soil mound surcharge and wick drains to “pre-settle” the Bay Mud, such that adding new fill would not cause new settlement of the Bay Mud (Surcharge and Wick Drains)
 - Because of the Giants’ baseball operations and parking needs and the time required for the surcharge program, this option was deemed to be infeasible; the mounds would need to be at least ten feet tall, making parking access impractical.

MEMO

- improving the ground through the bottom of the Bay Mud using deep soil mixing (DSM) (Ground Improvement)
 - We understand that for DSM to be a cost-effective alternative over piles, the depth of the soil to improve should be less than about 30 to 40 feet. With the thickness of fill and Bay Mud at this site averaging on the order of 90 feet, it would be cost prohibitive and impractical to try to improve the ground to support new fill loads.
- using lightweight foam (gefoam, or similar) to raise site grades (gefoam)
 - Utilities and streets would need to be supported on and within gefoam; when they needed to be repaired, the gefoam would need to be cut through and replaced in kind. We anticipate on-going maintenance of the gefoam would be required, which could be difficult.
 - Several of the gravity-fed utilities require that trenches be on the order of 10 to 12 feet deep; this would put Geofom below groundwater, which renders installation and maintenance difficult and impractical.
- supporting the streets and utility corridors on piles (Pile-Supported Streets)
 - This option was deemed to be the most practical, economical, and feasible for the site because:
 - relatively little street and utility settlement would occur and, thus, relatively little to no differential settlement between pile-supported streets and adjacent pile-supported buildings would occur
 - by pile supporting the streets, no new fill would be required; therefore, no downdrag loads would be induced on new piles supporting adjacent buildings (except where the streets surrounding the site have been raised)

Therefore, on a preliminary basis, the Mission Rock design team is moving forward with evaluating pile-supported streets and utility corridors for the proposed development.

We estimate that, due to the relatively recent placement of new fill along the southern portion of Third Street and along Mission Rock Street, new piles along the western and southern edges of SWL337 will be subjected to downdrag. We estimate this will affect piles for the southern 50 feet of planned structures at Parcels D and H and the proposed Bridgeview Street and for the western 25 feet of Parcels B, C, and D and the proposed Channel and Bosque Streets.

PRELIMINARY RECOMMENDATIONS FOR MISSION ROCK SQUARE GARAGE

Plans are to construct a three-level below-grade garage below the Mission Rock Square park and surrounding streets that will abut proposed Parcels B, C, E, F, I, and J, as shown on Figure 2. Preliminary plans show that the proposed lowest garage finished floor will be at approximate Elevation 73 feet. We are currently planning a geotechnical investigation in the

MEMO

MRSRG footprint to develop site-specific preliminary geotechnical recommendations for design; however, we have performed preliminary analyses based on the existing data at the site, and have the following preliminary conclusions:

- We are anticipating that the structural loads of the MRSRG plus some new soil atop the garage may be nearly balanced by the weight of soil removed for the excavation of the MRSRG, such that the new loads may be nearly a "net zero" addition.
- Although there may be a nearly "net zero" new load addition, there will be some rebound/heave of Bay Mud below the garage due to removal of soil load and some recompression of the Bay Mud as the new loads are applied.
- We anticipate it may be difficult logistically to add the same amount of fill at the proposed street and ramp areas as can be added in the park area, such that there may be some differential settlement between these structures.
- We are anticipating that a pile-supported mat or "raft" foundation system may be appropriate for support of the MRSRG; piles will likely be required mainly for settlement and uplift/heave control rather than actual structural load support.
- The shoring system should consist of a relatively rigid soil-cement-mixed, secant pile, soldier pile tremie concrete (SPTC) or diaphragm cutoff wall to resist earth and water pressures
- With a cutoff shoring wall extending into relatively impermeable Bay Mud, only the interior of the excavation will require dewatering.
- A concrete working pad with steel reinforcement should be constructed at the base of the excavation to reduce the potential for base heave and provide a relatively stable working pad for construction activities.
- On a preliminary basis, we estimate the allowable bearing capacity of the Bay Mud at Elevation 73 feet is on the order of 1,400 pounds per square foot (psf) for the temporary construction condition; this value includes a factor of safety of 2. For the permanent condition, we estimate the allowable bearing capacity of the Bay Mud at Elevation 73 feet is on the order of 1,900 psf; this value includes a factor of safety of 3. Care should be taken to minimize disturbance of the Bay Mud during construction. Disturbed Bay Mud will have lower strength and lower bearing capacity.

LIQUEFACTION MITIGATION CONSIDERATIONS

As discussed in our 23 December 2013 letter, *Liquefaction and Lateral Spread Potential at Seawall Lot 337*, there is a potential for the fill across the majority of the site to liquefy² and settle during a major earthquake. Additionally, we estimate there are localized areas within the site that are susceptible to lateral spreading³ as a result of liquefaction.

If liquefaction occurs, the ability of piles to resist lateral loads will be reduced, induced moments in the piles will be increased, and passive resistance at basement walls, pile caps and grade beams will be reduced. Where lateral spreading occurs, additional loading on piles and basement walls will occur due to the soil movement, which could cause significant foundation damage.

The Mission Rock design team is currently undergoing a study of the comparison of effects on design with and without liquefaction at the site. However, based on our experience, it may not be practical to design a foundation system to accommodate the loss of lateral capacity due to liquefaction and the lateral movement from lateral spreading. Deep foundation elements such as piles would need to be designed to resist large lateral deflections and associated moments.

Should it be decided to improve the ground against liquefaction, on the basis of our experience with different methods of improvement, we judge that the most appropriate methods to mitigate the potential for liquefaction and lateral spreading to occur at the site are:

- deep dynamic compaction⁴ (DDC)
- stone columns⁵

² Liquefaction is a transformation of soil from a solid to a liquefied state during which saturated soil temporarily loses strength resulting from the buildup of excess pore water pressure, especially during earthquake-induced cyclic loading. Soil susceptible to liquefaction includes loose to medium dense sand and gravel, low-plasticity silt, and some low-plasticity clay deposits.

³ Lateral spreading is a phenomenon in which surficial soil displaces along a shear zone that has formed within an underlying liquefied layer. The surficial blocks are transported downslope or in the direction of a free face, such as a bay, by earthquake and gravitational forces. Lateral spreading is generally the most pervasive and damaging type of liquefaction-induced ground failure generated by earthquakes.

⁴ Deep dynamic compaction (DDC) consists of the systematic dropping of a 10- to 20-ton weight or tamper from heights as high as 40 to 80 feet. The weight or tamper typically drops about 5 to 15 times per location at a rate of one to three drops per minute. Depending on the total energy input into the ground and subsurface conditions, deep dynamic compaction can generally be effective at densifying granular soils up to 20 to 30 feet deep.

⁵ Stone columns are a ground improvement technique that results in in-situ densification of granular soil. Stone column installation is accomplished using vibrating probes that are inserted to the desired depth of improvement and withdrawn. The voids created through densification are backfilled with gravel or crushed rock and compacted while withdrawing the probe, leaving a dense stone column typically 3 to 4 feet in diameter surrounded by densified soil.

Compaction grouting⁶ and rapid impact compaction⁷ (RIC) were also considered; however, both of these ground improvement methods were rejected for this site. Because of the grout injection pressures required for compaction grouting, we believe there is insufficient overburden (soil weight) to resist heave and properly improve the fill. Additionally, it has been our experience across Mission Bay that RIC has been only moderately successful in improving the ground and mitigating the potential for liquefaction and lateral spreading and, when successful on recent projects, the ground improvement was evident only in the upper about 10 feet. There are potentially liquefiable layers at the site that extend deeper than 10 feet below ground.

Further details regarding the use of DDC and stone columns at the site are provided in our 23 December 2013 letter.

PLANNED INVESTIGATION AND EVALUATIONS

We are planning additional subsurface investigation at the site, including drilling four borings at the four corners of the proposed MRSG footprint and three additional borings in the western portion of the site to fill in data gaps from previous investigations. Drilling for the additional investigation is currently scheduled to begin on 16 February 2016. The results of our investigation will be presented in a data report, which will present all of the previous borings and cone penetration tests (CPTs) performed at the site and the laboratory test results. We will also perform additional engineering analyses for the MRSG and will present those results and preliminary recommendations in a separate letter report. Other on-going analyses include evaluating the impacts on design with and without liquefaction, including site-specific seismic ground response analysis.

We trust that the foregoing is sufficient for the design team's needs at this time. If you have any questions, please call.

750604203.05B_CER_SWL 337_GTK Preliminary Design and Summary Memo_R1

Attachments: Figure 1 – Proposed Site Plan

Figure 2 – Allowable Friction Capacity, Driven 14-Inch Steel H-Pile and
14-Inch Square Precast Prestressed Concrete Piles

⁶ Compaction grouting is a ground improvement technique in which cement grout is injected under high pressure to increase the density of the soil, thereby reducing the liquefaction potential.

⁷ The rapid impact compaction method uses a Rapid Impact Compactor (RIC) to impart energy by dropping a 7.5 ton weight from a controlled height of about 1 m onto a patented foot. Applications include compaction of loose soils to improve bearing capacity and mitigation of liquefaction potential.

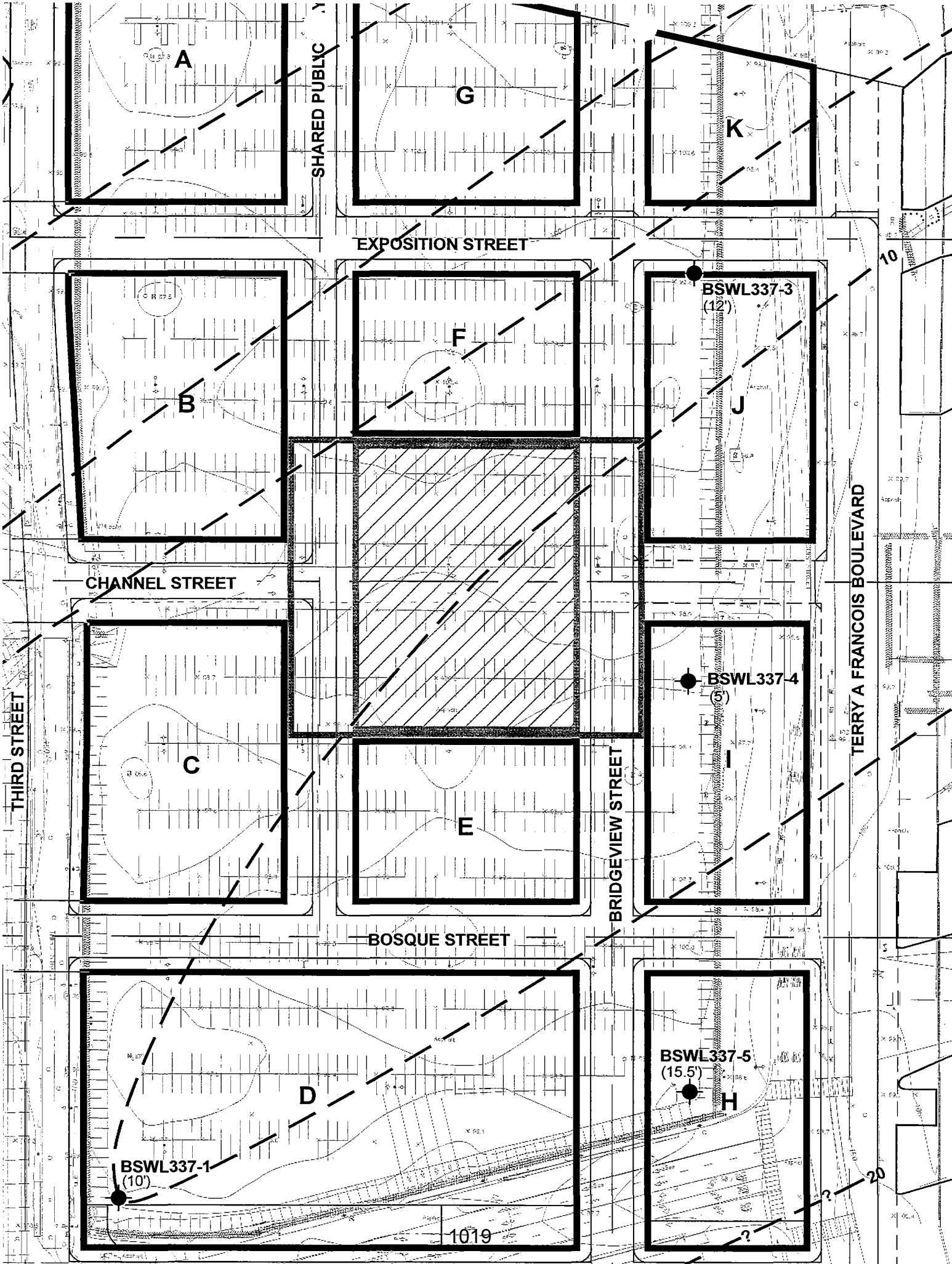

SHARED PUBLIC

EXPOSITION STREET

CHANNEL STREET

BOSQUE STREET

BRIDGEVIEW STREET

TERRY A FRANCOIS BOULEVARD

THIRD STREET

A

G

K

B

F

J

C

E

I

D

H

BSWL337-1
(10)

BSWL337-3
(12)

BSWL337-4
(5)

BSWL337-5
(15.5)

1019

10

20

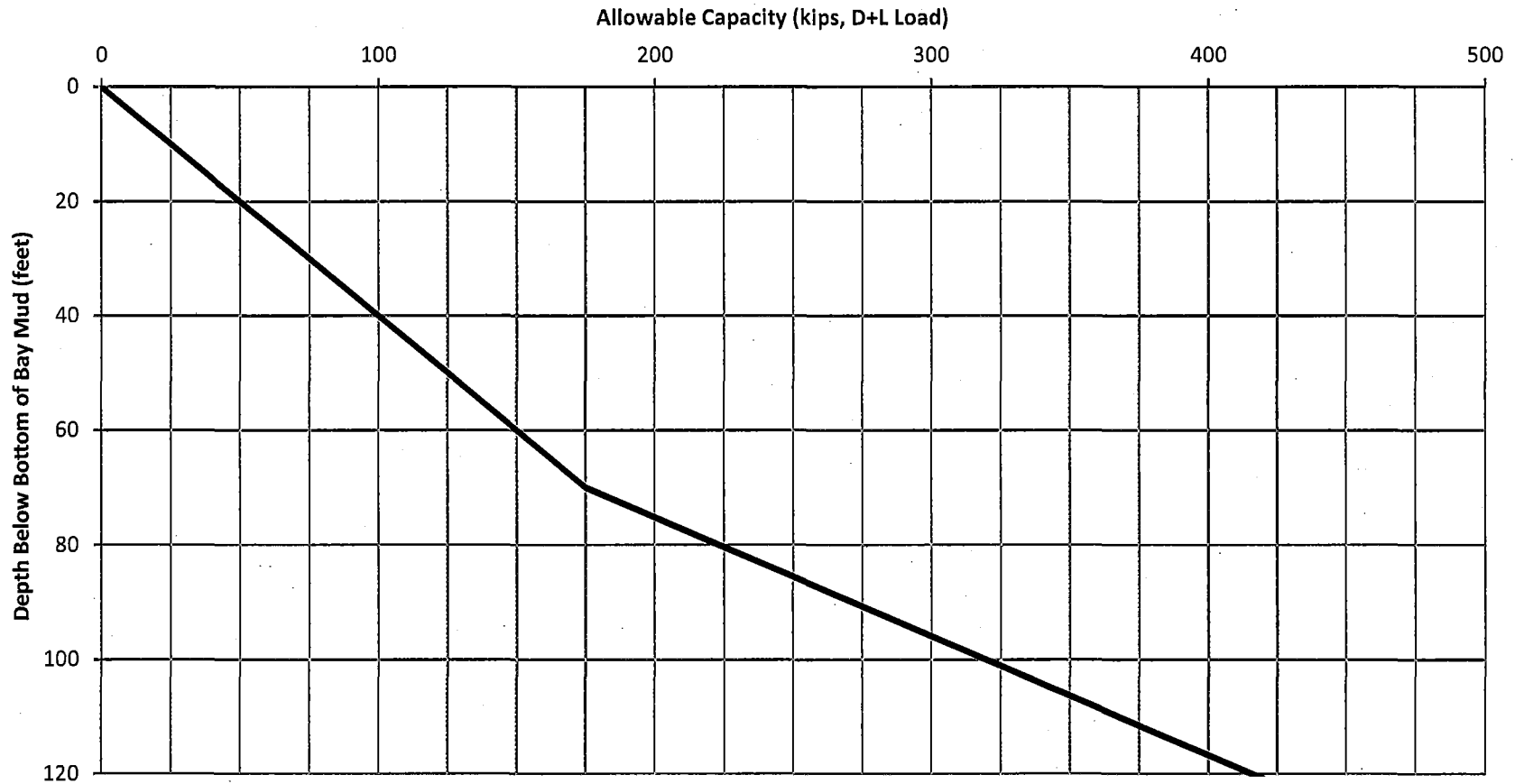

Notes:

- 1) Where refusal in dense sand or bedrock is encountered, the pile capacities in Table 1 will apply. Bedrock depths are expected to range between 100 to 160 feet below the bottom of Bay Mud.
- 2) Pile capacities do not include downdrag.
- 3) Pile capacities include a factor of safety of 2.

**MISSION ROCK DEVELOPMENT
SEAWALL LOT 337**

San Francisco, California

**ALLOWABLE FRICTION CAPACITY, DRIVEN
14-INCH STEEL H-PILE AND 14-INCH-SQUARE
PRECAST PRESTRESSED CONCRETE PILES**

Date 01/21/16 | Project No. 750604203 | Figure 2

LANGAN TREADWELL ROLLO

**APPENDIX G
(Not Used)**

APPENDIX H
District Energy Typical Trench Section

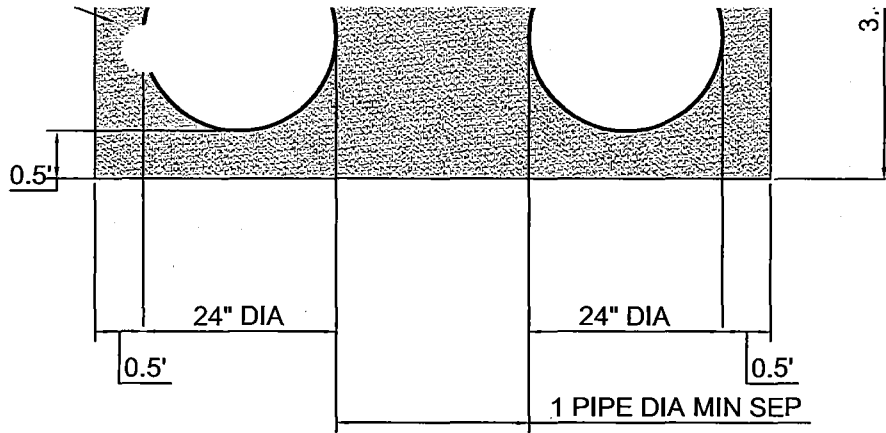

TYP BAY WATER COOLING TRENCH SECTION

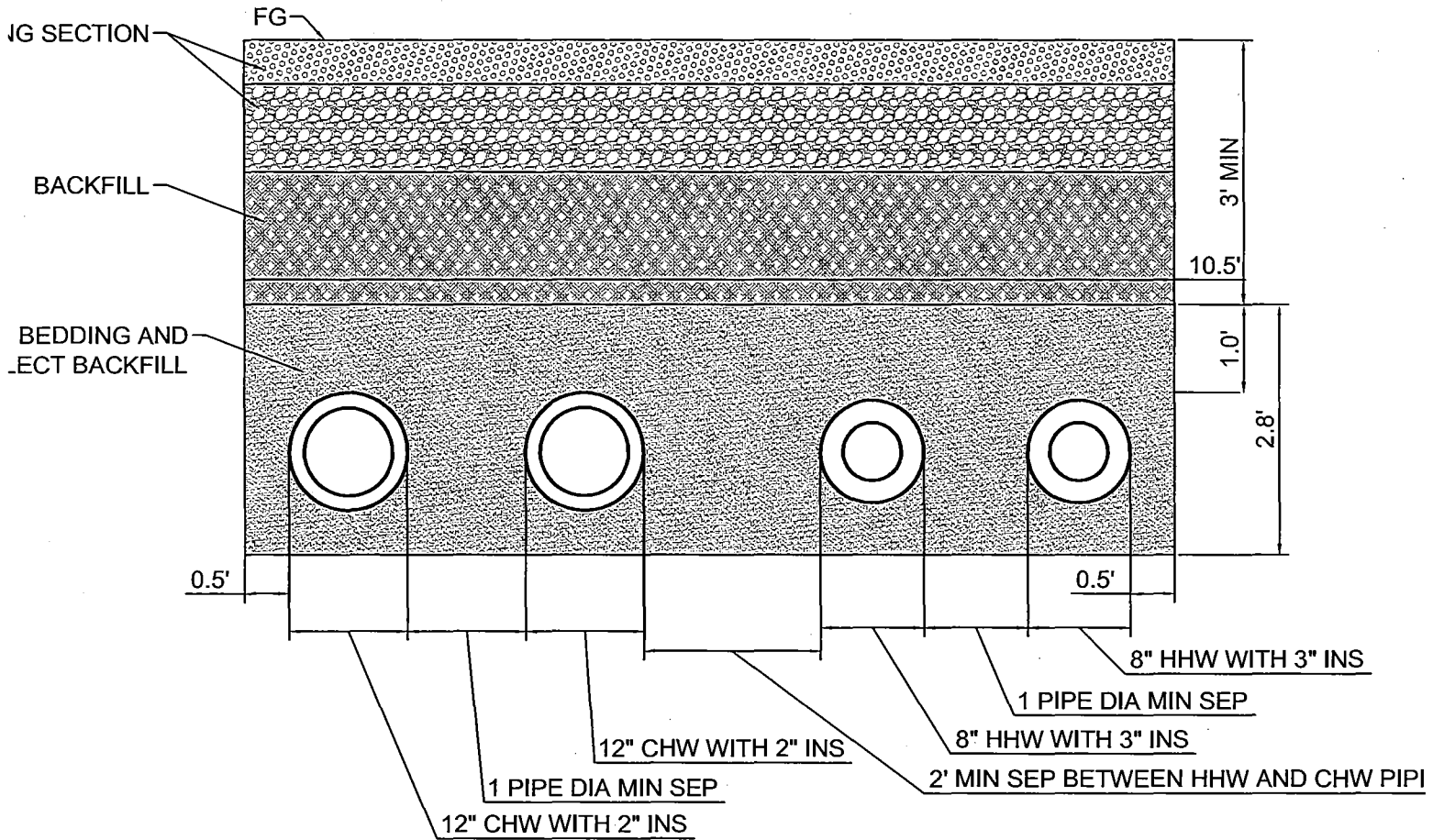

TYP DIST ENERGY TRENCH SECTION - SINGLE TRENCH

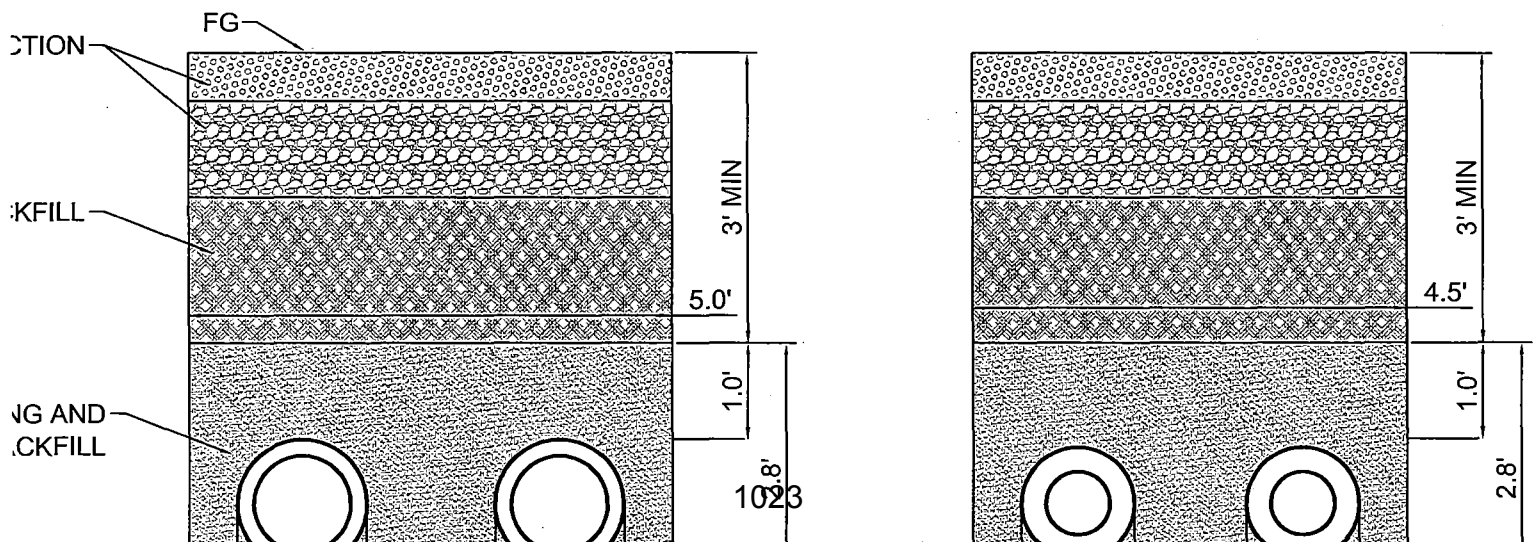

APPENDIX I
Sea Level Rise Adaptation Strategy
September 6, 2016



2185 N. California Blvd. Suite 500
Walnut Creek, CA 94596

(925) 944-5411
www.moffattnichol.com

MEMORANDUM

To: Jon Knorpp, Managing Director
From: Christopher Devick P.E. and Dilip Trivedi P.E.
Date: September 06, 2016
Subject: Mission Rock Development Seawall Lot 337
Sea Level Rise Adaptation Strategy

M&N Job No.: 7530-02

This memorandum serves to summarize the present understanding of sea level rise projections being used by regulatory agencies, flood elevations proposed by Federal Emergency Management Agency (FEMA), minimum proposed grades and a proposed adaptation strategy for the Mission Rock Development Project in San Francisco, CA.

Sea Level Rise Projections

In March 2013, the Sea-Level Rise Task Force of the Coastal and Ocean Working Group of the California Climate Action Team (CO-CAT) released their State of California Sea-Level Rise Guidance Document based on the recently published (June 2012) National Academy of Sciences (NAS) Sea-Level Rise for the Coasts of California, Oregon, and Washington. Table 1 summarizes the sea level rise (SLR) projections, including the low and high range values, for the San Francisco Bay area. Further, the CO-CAT guidance recommends that sea level rise values for planning be selected based on risk tolerance and adaptive capacity.

Table 1 Sea Level Rise Projections for San Francisco, California (feet; NAS 2012 Report)

Year	Projections	Ranges
2030	6 ± 2 in	2 to 12 in
2050	11 ± 4 in	5 to 24 in
2100	36 ± 10 in	17 to 66 in

Reference Water levels

Water levels used in developing the sea level rise strategy included the Base Flood Elevation for the development areas, and King Tide for China Basin Park as described below.

The *Base Flood Elevation* (BFE) is a regulatory standard for insurance purposes. The definition of the BFE, per FEMA, is "The flood having a one percent chance of being equaled or exceeded in any given year." Since development areas with building structures are subject to flood plain ordinance review by City building permit officials, the BFE is an appropriate reference water level to use for establishing finish floor elevations. The BFE can be represented by the 1% still water level, which was estimated based on

work conducted by BakerAECOM¹ for a flood study of the Central Bay region that included the vicinity of the proposed project.

King tide is a colloquial term for an especially high tide, such as a perigean spring tide that occur when the gravitational pull of the sun and the moon are in alignment. They occur only a few times a year and therefore are a good indicator for the potential disruption of use for areas such as open space and park areas. The elevation representative of a king tide was estimated based on a review of tidal elevation observations at the National Oceanographic and Atmospheric Administration Alameda, CA tide gauge. The estimated BFE and King Tide for the Project site are provided in Table 2.

Table 2: King Tide and Base Flood Elevations

Water Level	NAVD88, feet	Old City Datum, feet	Mission Bay Datum, feet
King Tide	7.3	-4.0	96.0
Base Flood Elevation (1% Still Water Level)	9.8	-1.5	98.5

Proposed Minimum Grades

The proposed minimum grades were developed for the project based on the following criteria:

- Reserve the entire 100-foot shoreline band for public access;
- Elevate buildings and immovable facilities high enough such that adaptations would not be necessary even for conservative estimates of SLR;
- Rather than elevate the zone between the development area and the shoreline for flood protection, maximize access opportunities to the water.

Based on these criteria, the following design elements have been adopted:

1. For the development area, the proposed strategy will raise existing grades to a minimum elevation of 104 feet Mission Bay Datum (MBD), which will provide a minimum of 5.5 feet (66 inches) of freeboard above present day BFE. Streets placed on fill would be pile supported within the raised development grade. This is necessitated by geotechnical considerations.
2. For the China Basin Park area, the promenade and Bay Trail are proposed to be raised to elevation 102 feet MBD which will provide approximately 6 feet of freeboard above the King Tide (or 3.5 feet of freeboard above present day BFE). Proposed grading for the Park includes transitioning from BayTrail/Promenade elevations of 102 MBD to development grade elevations of 104 feet MBD.

¹ BakerAECOM. 2012. A Central San Francisco Bay Coastal Flood Hazard Study San Francisco County, California Study Report. November 2, 2012.

3. The shoreline, Pier 48, Pier 50, Terry A. Francois Boulevard, 3rd Street and Mission Rock Street will remain at current elevations; proposed grading includes transitioning from these locations to Bay Trail/Promenade elevations of 102 feet MBD.

The above set of criteria and proposed grades are based on the principles of 'living with the Bay' and 'managed retreat' rather than elevating shoreline spaces now against future SLR. It also implies that the proposed improvements along the shoreline are for the purpose of flood protection for the open space area and do not serve as a levee or flood protection element for the developed area.

Shoreline Adaptation Strategy

In the development footprint, the proposed minimum grades (104 MBD) provide an elevation which will address potential flooding for even the highest estimates of sea level rise in 2100 for the San Francisco Bay Area by the NRC. Therefore, based on current sea level rise projections, the earliest when adaptations for the development area may be needed is 2100.

For the space between the development area and the Bay Trail/Promenade, proposed minimum grades (102 MBD) will address potential flooding beyond 2080 for even the highest estimates of sea level rise. From a functional perspective, the proposed grades (102 MBD, or 6 feet above King Tide) will address potential future flooding from King Tide events even beyond 2100. For higher estimates of sea level rise, the China Basin Park area functions as the space where future adaptations could be creatively implemented to maintain flood protection for the constructed public access features. Strategies to address larger amounts of sea level rise may include modifications to raise the promenade and reconfiguring the shoreline protection to provide flatter slopes and wave breaks. This will ensure continued protection of the public access open space areas from flooding.

In general, adaptation actions at the shoreline would be implemented when published information from NOAA indicate that flooding to the public access areas will occur during king tides. To implement future adaptations for sea level rise for the Park Area, a fund from an infrastructure financing district or community facilities district could be established now for the improvements needed to address sea level rise greater than the 3.5 feet (42 inches) allowance that is included in the proposed grades.

**APPENDIX J
(Not Used)**

**APPENDIX K
(Not Used)**

**APPENDIX L
(Not Used)**

APPENDIX M
District Heating and Cooling Services at Mission Rock
May 13, 2016



REQUEST FOR QUALIFICATIONS

District Heating and Cooling Services
At Mission Rock

San Francisco, California

Submission Date:

May 13, 2016

Table of Contents

1	INTRODUCTION	1
2	PROCUREMENT INFORMATION.....	2
2.1	Procurement Process.....	2
2.2	Submission of Qualifications.....	3
2.3	Questions	3
2.4	Evaluation of Qualifications	3
2.5	No Reimbursement for Costs.....	4
2.6	Representations.....	4
2.7	Eligible Respondents	4
2.8	Additional Contract Requirements	4
3	GLOSSARY OF DEFINITIONS	5
4	DESCRIPTION OF THE PROJECT SITE	7
4.1	Background.....	7
4.2	Project Site.....	7
5	DESCRIPTION OF THE PROJECT.....	11
5.1	Project Goals and Objectives	11
5.2	Project Technical Opportunity.....	12
5.3	Project Commercial Opportunity.....	17
6	REQUIREMENTS FOR THE SOQ	21
6.1	Proposed Project Team.....	21
6.2	Previous Experience	21
6.3	Technical Response	22
6.4	Commercial Responses.....	22
6.5	Blue Sky Discussion	23
ATTACHMENT A:	Draft Memorandum of Understanding.....	A-1
ATTACHMENT B:	Site Plan.....	B-2
ATTACHMENT C:	Draft Schematic of Planned Utilities	C-1
ATTACHMENT D:	Supplementary Technical Information	D-1
D.1	Thermal Generation Details.....	D-1

D.2	Distribution Details.....	D-1
D.3	Building Interconnections.....	D-3
D.4	Anchor Brewing Process Loads.....	D-3
ATTACHMENT E:	Assumptions	D-1

Tables:

Table 1: Phasing Program and Land use details	8
Table 2: Indicative Performance Thresholds	11
Table 3: Project Site Performance Requirements and Sustainability Targets.....	12
Table 4: DES conceptual design basic information	13
Table 5: Estimated Non-Concurrent Peak Heating and Cooling – By Parcel.....	13
Table 6: Estimated Non-Concurrent Peak Heating and Cooling, without P48 – By Phase.....	14
Table 7: Load diversities.....	14
Table 8: Estimated Concurrent Peak Heating and Cooling	14
Table 9: Estimated Peak Non-Concurrent Heating and Cooling for Anchor.....	16
Table 10: Potential Commercial Allocations	17

Figures:

<i>Figure 1: Potential CUP Siting Locations.....</i>	15
Figure 2: Typical Bay Water Intake/Outflow Section	D-2
Figure 3: Chilled and Hot Water Combined Trench - Maximum Section.....	D-2
Figure 4: Chilled Water Trench - Maximum Section	D-2
Figure 5: Heat Hot Water Trench - Maximum Section.....	D-3
Figure 6: Substation Depiction	D-3
Figure 7: Ultimate Energy Consumption Split (400,000 Barrels/Year, no Brewery Efficiency)	D-4
Figure 8: Hypothetical Ultimate Energy Consumption Estimates (400,000 barrels/year)	D-5
Figure 9: Development Thermal Load Map	D-6

1 INTRODUCTION

Through this Request for Qualifications (“RFQ”), Seawall Lot 337 Associates LLC (“Master Developer”) is soliciting Statements of Qualifications (“SOQs”) from energy services companies (“Respondent” or “DES Developer”) that describe their proposal and capabilities to build, own, and operate (“BOO”) a district scale heating and cooling plant as well as operate and maintain a district scale distribution system (the “Project”) in the Mission Rock development (“Project Site”), which is a private real estate development located on public land that will be ground leased from the Port of San Francisco for a period not to exceed 75 years.

The intention is for the Project to be developed through a private-to-private partnership between the Master Developer and DES Developer. The Master Developer is open to a variety of business models and commercial structures and is input from the DES Developer to this end.

Master Developer is interested in selecting a firm that has direct experience in developing, designing, building, financing, operating and maintaining projects similar to the Project, and that will deliver the Project to meet the goals, standards, performance requirements, and schedule outlined this RFQ.

2 PROCUREMENT INFORMATION

2.1 Procurement Process

This RFQ provides the information necessary for Respondents to prepare and submit SOQs for consideration by Master Developer. The following describes the general procurement process:

- Collecting SOQs in response to this RFQ is the first step in selecting a firm.
- Once SOQs are received, Master Developer will choose a shortlist of Respondents for in depth site visits and interviews.
- After interviews, a DES Developer will be selected and enter into a Memorandum of Understanding (MOU), under which Master Developer and DES Developer will negotiate the final terms and conditions of an Energy Service Agreement (ESA).

This RFQ is not an offer to enter into an agreement with any Respondent; it is a request to receive SOQs from companies interested in developing the Project. The Master Developer reserves the right to reject all SOQs, in whole or in part, and/or enter into negotiations with any party to provide such services, whether or not a SOQ has been submitted. Master Developer will not have any obligation to any Respondent unless and until it has entered into a written agreement with terms and conditions agreed to by to Master Developer. Master Developer may enter into discussions or negotiations with a Respondent with respect to any SOQ or otherwise, which shall not be deemed to be an acceptance of such SOQ or an agreement with the Respondent.

The City and County of San Francisco (“City”), the Port of San Francisco (“Port”), and various other agencies are aware of the Project and have been involved in the process to date; however, it should be noted that this is a private RFQ that does not fall under the City’s Public Procurement Policies or any other competitive bidding requirements. During the RFQ process, no Public Agency may be contacted in regards to the Project.

2.1.1 Procurement Schedule

- Release: March 28, 2016
- Onsite Project Presentation and Q&A: Week of April 11th
Location:
Arup Office
560 Mission St, Floor 7
San Francisco, CA 94105
- Submission Due Date: May 13, 2016
- Anticipated Selection Date: June 15, 2016
- MOU Execution: no later than June 30, 2016
- ESA Substantially Complete: November 1, 2016 (estimated)

2.2 Submission of Qualifications

Statements of Qualifications must be submitted via internet link only, which is provided below. No hard copies will be accepted.

[Internet link to be provided]

SOQs must use a minimum of 11 point font and be no more than 25 pages not including attachments. Attachments should be limited to items such as resumes, information on requested projects, and other materials pertinent to the evaluation but not suitable for including in written response.

Materials submitted as part of the SOQ will be subject to provisions in the NDA executed by the Respondents prior to receiving this RFQ. However, Master Developer may wish to use ideas or concepts presented by Respondents in the SOQ and reserves the right to do so subject to confidentiality.

2.3 Questions

Respondents shall direct all questions regarding this RFQ in writing to the Point of Contact. The Point-of-Contact may or may not choose to answer questions and may share questions and answers with all responding parties unless it is clearly marked as confidential information by the submitting Respondent.

2.3.1 Point of Contact

The below individuals are designated as Point-of-Contact for this RFQ:

Fran Weld, Vice President Development, San Francisco Giants
fweld@sfgiants.com

Orion Fulton, Sr. Manager, Arup
Orion.fulton@arup.com

2.4 Evaluation of Qualifications

Master Developer reserves the right to select the best Respondent for its partnership requirements; however, in general, the evaluation of the Qualifications shall be based on, but not limited to:

- Prior project experience with developing and operating similar scale systems;
- History of partnerships with other organizations, experience with urban systems with multiple off-takers;
- Ability to vertically integrate the development process; and
- Compatibility with Master Developer's stated goals and requirements in this RFQ.

Master Developer intends to evaluate SOQs submitted in response to this RFQ based on the completeness of the information provided, the business and technical merits as they address the goal of the Project, and any other factors that the Master Developer determines.

Following the submission of SOQs, Master Developer may request supplemental information from Respondents on an individual or group basis and may elect to meet with certain Respondents in person. Master Developer intends to select a Respondent that will serve the best interests of the Project as determined by Master Developer in its sole discretion.

2.5 No Reimbursement for Costs

In submitting an SOQ, Respondent acknowledges and accepts that any costs incurred from the participation in this RFQ procurement process shall be at the sole risk and responsibility of the Respondent, and the Master Developer will not compensate Respondents for any expenses incurred in qualifications preparation or for any presentations that may be made.

2.6 Representations

Master Developer makes no representations of any kind that an award will be made as a result of this RFQ. Master Developer reserves the right to accept or reject any or all SOQs, delete any item/requirements from this RFQ when deemed to be in Master Developer's best interest, consider factors not included in this RFQ, or select a DES Developer that did not respond to the RFQ.

2.7 Eligible Respondents

Only individual firms or lawfully formed business organizations may apply. The Master Developer intends to contract only with a Prime Firm. This does not preclude a Respondent from using subcontractors or consultants, but a Prime Firm must be identified and be the entity submitting the SOQ. The Prime Firm must demonstrate in the SOQ it has the ability to represent any and all subcontractors or members of its team. Joint Ventures are not encouraged.

2.8 Additional Contract Requirements

Under its agreement with the Port, Master Developer, as well as The Prime Firm and all other members of the Project Team, are obligated to comply with all applicable City and Port requirements in effect at the time that Master Developer's Development Agreement with the Port is executed. In submitting an SOQ, a Respondent acknowledges and accepts that if selected, it will be obligated to comply with all City and Port requirements, including without limitation, Non-Discrimination in Contracts and Property Contracts (Admin. Code Chapters 12B and 1C) and Health Care Accountability Ordinance (Admin. Code Chapter 12Q). DES Developers are obligated to become familiar with all applicable local, state, and Federal requirements and to comply with them fully as they are amended from time to time. City ordinances are currently available on the web at www.sfgov.org. It is a stated goal of Master Developer to promote and encourage contracting and subcontracting opportunities for Local Business Enterprises ("LBE") in all contracts. The target goals for each phase of development are:

- Entitlements 10%
- Horizontal Infrastructure Development 20%

3 GLOSSARY OF DEFINITIONS

The following terms and acronyms are used within this RFQ:

Arup	Master Developer's procurement advisor
BOO	Build Own Operate
BTU or btu	British Thermal Unit
CHP	Combined heat and power system
City	City and County of San Francisco
CUP	Central Utility Plant
DES	District Energy System
DES Developer	The entity selected as the preferred contracting entity via the RFQ evaluation process, that once selected, that will perform the works described in this RFQ and its SOQ
Project	The district scale heating and cooling plant and related O&M functions
EIR	Environmental Impact Report
ESA	Energy Service Agreement
ETS	Energy Transfer Stations
GAAP	Generally accepted accounting principles
gsf	Gross square feet
HUB	Historically underutilized business
IFRS	International financial reporting standards
kW	Kilowatt
kWh	Kilowatt-hour
Lead A/E Firm	Lead architecture and/or design engineering firm
Lead Contractor(s)	Contractor(s) in the Project Team who are responsible for engineering, procurement and construction ("EPC") and Operation and Maintenance ("O&M") functions
Master Developer	Seawall Lot 337 Associates LLC
MMBTH	One million BTUs per hour
Mission Rock	The name for the development of Seawall Lot 337 and Pier 48, for the purposes of this RFQ, see "Project Site" below
MOU	Memorandum of Understanding
MW	Megawatt
O&M	Operation and Maintenance
PA	Project Agreement
PG&E	Pacific Gas & Electric
psig	Pounds per square inch gauge
Prime Firm	The organization considered to be lead Respondent/DES Developer entity (if not a joint venture)
Port	Port of San Francisco
Project Site	Seawall Lot 337 and Pier 48; the area that the DES serves
Project Team	All key entities that comprise the DES Developer organization

Public Agency	Port, City, SFPUC, PG&E, or other agency representing the public interest
Respondent	The contracting organization/entity that submits the SOQ, on behalf of the Project Team.
RFQ	Request for Qualifications
SEC	Security and Exchange Commission
SFPUC	San Francisco Public Utilities Commission
SOQ	Statement of Qualifications
T&C's	Terms and conditions
Vertical Developers	Future holders of individual ground leases within the Project Site to build commercial real estate

4 DESCRIPTION OF THE PROJECT SITE

4.1 Background

In 2008, the San Francisco Giants won a public bid for the exclusive development rights to this property. Over the last eight years, the Giants, which formed Sea Wall Lot 337 Associates LLC to act as master developer, have worked with the community to develop a comprehensive land use plan, and in November of 2015, this plan was voted on and passed by the voters of San Francisco.

A key element of the future neighborhood is a robust sustainability plan. This plan will outline topics such as material selection, climate change resiliency, water re-use, and energy; and the DES is expected to play a central role in achieving some of the sustainability goals.

4.1.1 Urban context

Given its size and location, SWL 337 is one of the Port's most desirable development sites. Consistent with the Port's land use policy document, the Waterfront Land Use Plan, the Port engaged in a multi-year public planning process culminating in the following vision statement for development of the parcel:

Create a vibrant and unique mixed-use urban neighborhood focused on a major new public open space at the water's edge. This new neighborhood should demonstrate the highest quality of design and architecture, and the best in sustainable development with a mix of public and economic uses that creates a public destination which enlivens the Central Waterfront, celebrates the San Francisco Bay shoreline, and energizes development at Mission Bay.

The Project Site also includes Pier 48, a pile-supported 212,500 square-foot facility containing about 181,200 square feet of enclosed warehouse space and a 31,300 square-foot valley. Pier 48 is bounded by China Basin on the north, Pier 50 on the south, and Terry Francois Boulevard to the west. Pier 48 was originally constructed in 1928 and is the southernmost pier structure in the Port of San Francisco Embarcadero Waterfront Historic District, which is listed in the National Register of Historic Places.

Through the planning process, the Port identified the following objective for Pier 48, if included in any development proposal for SWL 337:

Propose a use program for Pier 48 that is publicly-oriented and water-related to the extent possible, and which complements and enhances the public use and enjoyment of the major new open space at China Basin. The Pier 48 use program must be consistent with the public trust, and any improvements must comply with the Secretary of the Interior Standards for Rehabilitation.

4.2 Project Site

Seawall Lot 337 and Pier 48 are owned by the Port of San Francisco, and together form the Project Site. Seawall Lot 337 is a rectangular parcel bound by Terry A. Francois Boulevard to

the north and east, Third Street to the west, Mission Rock Street to the south. Seawall Lot 337 is currently a surface parking lot just south of AT&T Park known as Parking Lot A.

The Project Site will include 8 acres of parks and open space, approximately 3.5 million square feet of development with a mix of housing, offices, parking, and neighborhood serving retail, as well as historic Pier 48 which may become home for a new brewery by Anchor Brewing. More information can be found at <http://missionrock.org/index.html#>.

See Attachment B for a site plan showing land uses and phasing.

4.2.1 Relationship of Parties

- Port of San Francisco: Owners of Project Site
- The City of San Francisco: land use and development regulation,
- Seawall Lot 337 Associates LLC: Master Developer, holds the exclusive rights to develop Mission Rock
- Anchor Brewery: Intended tenant for Pier 48
- Arup: Master Developer’s DES concept designer & procurement advisor

4.2.2 Land Use Program and Phasing

Phasing

The Project Site is divided into 12 buildable Parcels not including Pier 48, 11 of which will be developed in Phases of Parcels. The 11th parcel (parcel D2) would hold the structured parking. The table below shows the draft phasing program, including the Mission Rock ground-level parking and Pier 48:

Table 1: Phasing Program and Land use details

Phase	Parcel	Land Use	Building Height	Building Stories	Gross SF (a)
1	A	Residential	240 ft.	23 Stories	413,900
	B	Office	118 ft.	8 Stories	274,750
	G	Office	188 ft.	13 Stories	303,064
	K	Residential	120 ft.	11 Stories	130,469
	Pier 48	Industrial	n/a	n/a	263,000
2	C	Office	188 ft.	13 Stories	354,826
	D1	Residential	240 ft.	23 Stories	240,494
	D2	Parking	100 ft.	10 Stories	851,130
3	E	Office	90 ft.	6 Stories	141,330

Phase	Parcel	Land Use	Building Height	Building Stories	Gross SF (a)
	F	Residential	240 ft.	23 Stories	323,775
	Mission Rock Square	Parking	0 ft.	0 Stories	227,180
4	H (Flex)	Office	90 ft.	6 Stories	151,932
	I (Flex)	Residential	120 ft.	11 Stories	200,315
	J (Flex)	Office	90 ft.	6 Stories	151,982
TOTAL	-	-	1824 ft.	153 Stories	3,977,647

Land Use Program

A key element of the Master Developer's land use program is the ability to respond to future market demands through flexible zoning. To this end, eight parcels are proposed to be designated as either predominantly residential (Parcels A, D, F, and K) or commercial/office (Parcels B, C, E, and G) above the lower-floor active uses, while three parcels would be flexible to allow either type of land use (Parcels H, I, and J) above the lower floor.

On the flexible parcels, the land uses (i.e., residential or office/commercial), would be determined at the time of filing for design approvals for block development proposals. Parcels designated for flexible zoning would ultimately be developed for either predominantly residential or pre-dominantly commercial/office uses above the lower floor. In all circumstances, ground floor retail and restaurant uses would be included in the flexible zoning parcels. The square footage for the flex option by land use is as follows:

- Commercial: 1,377,884 gsf
- Parking: 1,078,310 gsf
- Production: 263,000 gsf

For more information, the following describes in general terms the type of land uses proposed at the Project Site.

- **Retail, Restaurant, and Ground Floor Spaces.** 241,038 gsf to 244,777 gsf of retail and restaurant space located on the ground floor of residential and commercial buildings throughout the site. These totals do not include development at Pier 48.
- **Housing.** Housing will be located throughout the site, between 1,048 and 1,579 residential units predominantly consisting of one and two bedroom apartments. Housing would be provided on Parcel A, D, F, K and potentially on flexible Parcels H, I, and/or J.
- **Office.** Office space would primarily be located along Third Street and the south end of the proposed Mission Rock Square and at China Basin Park. Between 972,175 gross sq. ft. to 1,361,181 gsf of office space would be developed on Seawall Lot 337. Office uses would be provided on Parcels B, C, E, and G and potentially on the flexible Parcels H, I, and/or J.
- **Open Spaces and Parks.** Approximately eight acres of new and expanded public open spaces would be included: expanded China Basin Park totaling 5.12 acres, Mission Rock

Square totaling 1.1 acres and located in the center of the Project Site. Channel Wharf would be a 0.5-acre, hardscaped plaza, located between Pier 48 and Pier 50. Lastly, the Pier 48 Aprons, totaling 1.1 acres, would be preserved and improved for public access, waterfront promenade, and maritime operations.

- **Parking.** Included in the proposed parking structure on Parcel D at the southwest corner of the Project Site would be 2,300 parking spaces for use by the Project and for the ballpark games and events, and other public parking, including commuter parking/park-and-ride. In addition to the above-grade structural garage parking on Parcel D, 700 parking stalls would be located under Mission Rock Square and adjacent streets. During game days, approximately 2,000 of the parking structure stalls in the two proposed garages would be available for use to the patrons of AT&T Park. An additional approximately 100 parking stalls would be provided within residential and commercial buildings, for a maximum of 3,100 off-street parking spaces.
- **Pier 48.** Pier 48 would be rehabilitated in compliance with the Secretary of the Interior's Standards for the Treatment of Historic Properties, with a mix of uses in the 240,000-sf rehabilitated pier, including light industrial/manufacturing, barging, ancillary office, storage, retail, restaurants, tours, events, and continued maritime operations on the east and south side and along Channel Plaza.

It is currently anticipated that the Anchor Brewing Company would occupy all of the interior usable space of Pier 48 under a 30-year Port interim lease. The retail/restaurant spaces provided at Pier 48 would include 11,000 gsf of brewery retail/exhibition space, 11,000 gsf of brewery restaurant space, and 10,000 gsf of other retail space. An additional 7,875 gsf of office space would be provided on Pier 48. The brewery/distillery would be up to 190,500 gsf and a separate production area would consist of 9,625 gsf.

4.2.3 Site Utilities

Utility provider contracts are still being developed. The Master Developer is currently undecided between Pacific Gas & Electric (PG&E) and San Francisco Public Utilities Commission (SFPUC) as the power utility. Input on this decision may be solicited from the DES Developer once the MOU is signed.

The opportunity to provide electricity into the development from the DES is described further in Section 5.2.4.

4.2.4 Project Site Entitlement Schedule

Key milestones in the Mission Rock entitlements are as follows:

- Publish Public Draft EIR July/Aug 2016
- Financial Negotiations with City through September 2016
- EIR Certification January 2017
- Port and City Approvals January 2017
- Regional (BCDC) and State (SLC) Approvals February 2017
- Begin Design of Phase 1 March 2017
- Complete construction of first building in Phase 1 Q1 2019 [approximate]

5 DESCRIPTION OF THE PROJECT

5.1 Project Goals and Objectives

5.1.1 Project Goal

The Project goal is to develop a district scale solution to heating and cooling buildings at the Project Site that meets the stated performance and sustainability objectives.

5.1.2 Project Objectives

The following are the primary project objectives (described without any order of importance or preference):

- Enter into a long-term contract(s) that provides vertical developers with budget certainty and economic value for thermal services;
- Leverage the creative problem solving capacity of the energy marketplace;
- Be a good steward of natural resources, including water resources; utilize reclaimed water service for cooling tower fill (assuming a source is available);
- Achieve a resilient utility infrastructure (with appropriate redundancy) that will deliver critical energy requirements during normal and emergency conditions;
- Fit proposed CUP or CUPS within allocated parcel space(s) and heights;
- Review, comment, and provide concurrence for DES distribution design;
- Meet Minimum Performance Requirements (see Section 5.1.3); and
- Help achieve the sustainability objectives (see Section 5.1.4).

5.1.3 Minimum Performance Standards

Though not yet formalized, the Master Developer will set energy efficiency and environmental performance thresholds that the DES Developer will need to meet. For purposes of the RFQ, indicative performance thresholds are provided in Table 2 below.

Table 2: Indicative Performance Thresholds

Annual Average Efficiency				
Chilled water plant	Maximum	0.45	kW/Ton	Inclusive of chillers, all primary & secondary distribution pumps, and heat rejection
Heat recovery chiller plant	Maximum	0.68	kW/Ton	Inclusive of chillers, all primary & secondary distribution pumps, and heat rejection
Boiler combustion	Minimum	86.5 0%	%	Per individual boiler fuel & btu meter trend data
Chilled water distribution	Minimum	98.7 5%	%	Per plant leaving chilled water btu meter & aggregate of customer chilled water btu meter trend data
Hot water distribution	Minimum	98.2 5%	%	Per plant leaving hot water btu meter & aggregate of customer hot water btu meter trend data

5.1.4 Sustainability Objectives for Vertical Development

The Master Developer has sustainability performance requirements and targets for both horizontal and vertical development.¹ These sustainability performance requirements and targets for Mission Rock, shown in Table 3, are consistent with San Francisco Eco-Districts guidelines, of which Mission Rock is a Type-1 Eco-District.² The DES Developer will assist in achieving these by delivering energy that is highly efficient and environmentally friendly.

Table 3: Project Site Performance Requirements and Sustainability Targets

Performance requirements	Sustainability targets
<ul style="list-style-type: none"> • Up to 26% better than ASHRAE 90.1-2010 • Net zero potable water use for non-potable uses • LEED Gold for commercial buildings • LEED Gold for residential buildings 	<ul style="list-style-type: none"> • Each building type can exceed future code and achieve an exceptional level of energy performance. • The Mission Rock development looks to improve upon the city’s leading emissions performance by further reducing annual carbon emissions associated with energy use by up to 19%. • 100% renewable energy by 2030 • Water conservation and reuse strategies with a target of up to 47% reduction in annual carbon emissions associated with water. • Municipal solid waste diversion in San Francisco is about twice the national average, significantly decreasing the GHG emissions associated with landfill waste disposal. As there is still room for improvement in waste diversion, Mission Rock is targeting a further 25% reduction in annual carbon emissions associated with waste, compared to current San Francisco performance.

5.2 Project Technical Opportunity

The main technical scope is to offer central combined heating and cooling with bay heat rejection and cooling (if permissible). However, there are a number of enhancement opportunities on the technical delivery discussed in this section.

The chosen DES Developer will be required to satisfy themselves of the peak design loads for the Site after the MOU is executed. However, for purposes of this RFQ, Arup’s reference design and load calculation shall be used.

The DES is comprised of three major components:

¹ The sustainability plan is currently in draft form and may change during this procurement, with possible input from the DES Developer

² <http://www.sf-planning.org/index.aspx?page=3051>

- One or more central utility plants (CUP or CUPs)
- A thermal utility distribution system
- The energy transfer stations (ETS) within each building/parcel

Table 4 summarizes reference design information and further information is provided in subsequent sections and in Attachments D and E:

Table 4: DES conceptual design basic information

Design and Construction Stage	
CUP	Central Combined Heating & Cooling + Bay Heat Rejection & Cooling
CUP System	<ul style="list-style-type: none"> • Centralized heat recovery chillers • Centralized electric water cooled chillers • Centralized low/medium temperature hot water boilers • Plate-and-frame “free-cooling” heat exchangers (bay-water) • Plate-and-frame “heat-rejection” heat exchangers (bay-water) • Balance of bay-water heat rejection and cooling plant • Minimal cooling towers
Distribution System	<ul style="list-style-type: none"> • The planning basis for the distribution portion of the DES has assumed a 6-pipe system comprising of: • Chilled water (CHW) supply and return pipes • Heating hot water (HHW) supply and return pipes • Bay water intake and outflow pipes • Parcel level electrical infrastructure

5.2.1 Estimated Heating and Cooling by Phase

Non-concurrent Peak Loads

The land-use heating and cooling peak load density assumptions (see Attachment E) yield the following peak non-concurrent loads in the tables below.

Table 5: Estimated Non-Concurrent Peak Heating and Cooling – By Parcel

PARCEL	PRIMARY USE	PARCEL AREA (sqft)	TOTAL GFA (sqft)	Cooling (Tons)	Heating (MMBH)
A	Residential	42,150	413,900	591.3	4.1
B	Commercial	40,209	274,750	686.9	4.1
C	Commercial	39,124	354,826	887.1	5.3
D1	Residential	9,745	240,494	343.6	2.4
D2	Parking	86,161	851,130	n/a	n/a
E	Commercial	25,110	141,330	353.3	2.1
F	Residential	25,110	323,775	462.5	3.2
G	Commercial	33,057	303,064	757.7	4.5
H	Commercial	31,144	151,932	379.8	2.3
I	Residential	32,543	200,315	286.2	2.0

PARCEL	PRIMARY USE	PARCEL AREA (sqft)	TOTAL GFA (sqft)	Cooling (Tons)	Heating (MMBH)
J	Commercial	31,515	151,982	380.0	2.3
K	Residential	17,857	130,469	186.4	1.3
P48	Production	259,328	263,000	657.5	1.3

TOTAL, without P48

5,315 **33.8**

TOTAL, with P48

5,972 **35.1**

Table 6: Estimated Non-Concurrent Peak Heating and Cooling, without P48 – By Phase

Assumed Phase	Parcel	Heating (MMBH)	Cooling (Tons)
1	A, B, G, K	14.1	2,222
2	C, D1, D2	7.7	1,231
3	E, F	5.4	816
4	H, I, J	6.6	1,046
Total:	-	33.8	5,315

Concurrent Peak Loads

Arup estimates that the concurrent load diversities for the mix of uses in the flex parcel option are:

Table 7: Load diversities

	Cooling	Heating
w/out P48	10%	2%
w/P48	8%	2%

Table 8: Estimated Concurrent Peak Heating and Cooling

	Cooling (Tons)	Heating (MMBH)
w/out P48	4,791	33.1
w/P48	5,517	34.3

5.2.2 Plant Location Considerations

Possible plant locations are constrained by size, phasing, and general location. The potential locations for siting CUP's are illustrated in Figure 1 below.

Figure 1: Potential CUP Siting Locations

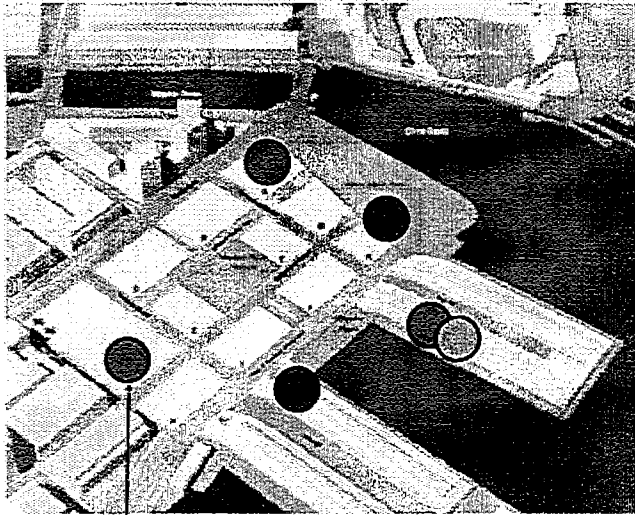

Available when parcel is built. Refer to assumed phasing plan elsewhere in the RFQ.

● **Process Plant**

- Anchor plant for brewing process
- High pressure steam required
- Medium-high temperature hot water required (170 °F)
- Low temperature chilled water required (< 36 °F)
- Total area is currently unknown

● **Comfort Heating/Cooling Plant**

- Central plants for building comfort heating & cooling equipment
- Elevated chilled water preferable (> 50 °F)
- Low temperature hot water preferable (< 150 °F)
- Connection to Bay to reduce cooling towers & maximize cooling efficiency
- Total area is between 24K & 35K sf plus some roof space (TBD)
 - Phase 1 Plant ~12K to ~20K sf

A consideration relating to siting the CUP is the nature of Pier 48. It has a limited clear height that roughly ranges between 20 feet at the edges and 35 feet at the core, load bearing limits due to pile foundation and bay muds, and sea level rise considerations.

Potential partners will need to propose solutions that are nimble and flexible so that the complexity and uncertainty introduced by the project phasing can be overcome.

5.2.3 Distribution System Considerations

The distribution system routing options are being planned along with other utilities in the public rights-of-way (ROW). Utilities are generally constrained along Exposition St and Bosque St. Further, utilities will not be placed in the Terry A Francois Blvd ROW until parcels I/J/K are built. A large parking structure is planned at the podium level beneath Mission Rock Square between parcels B and C to the West and parcels I and J to the East and between Exposition St to the North and Bosque St to the South. Rights-of-way for Shared Public Way and Bridgeview Way are currently being considered for the distribution system but this may require running the pipes inside the garage. Finally, the ROW north of parcels A, G, and K and South of China Basin Park is generally free of utilities. Please see Attachment B for a draft schematic of the planned utilities.

The selected DES Developer will be expected to provide input to, and ultimately concur with, the routing and design of the distribution system.

5.2.4 Anchor Brewing

It is currently anticipated that the Anchor Brewing Company would occupy all of the interior usable space of Pier 48 under a 30-year Port interim lease. Anchor Brewing has indicated that it will be developing, as part of the new brewery, a process plant capable of supporting the

production of approximately 200,000 barrels annually. This figure is subject to change by Anchor.

The technical opportunity includes the following heating and cooling loads for the Anchor site. This does not include any heating and cooling loads that Anchor may require for their production needs. See Attachment D section D.5 for more details on Anchor’s production loads.

Table 9: Estimated Peak Non-Concurrent Heating and Cooling for Anchor

Assumed Phase	Parcel	Heating (MMBH)	Cooling (Tons)
n/a	P48	1.3	658

Anchor Brewing Enhancement Opportunities:

There may be an opportunity to:

- Pre-heat the Anchor Brewing process hot water using the district heating system and distribution, thereby reducing the required steam boiler capacity in the Anchor Brewing process plant. This might be achievable under a scenario where an extensive distribution run from the closest main branch is not required.
- Operate and Maintain the Anchor Brewing process plant under a performance contract or other form of contract. This will require discussions with Anchor Brewing directly during the RFQ procurement.
- Run microturbines for cogeneration of electricity as part of the Anchor Brewing process plant operation. Again, discussions with Anchor Brewing directly during the RFQ procurement will be required to better understand this opportunity. [The environmental impacts of cogeneration may be addressed as part of the Mission Rock EIR.]

5.2.5 Bay Water Heat Rejection & Cooling

The inclusion of bay water as a means for heat rejection & cooling is an important aspect of the DES design as it relates to sustainability performance. Not only will it save considerable amounts of energy and water, it will also alleviate site design concerns related to cooling towers that would otherwise be needed. Master Developer expects this technology to be pursued as part of the DES design, construction, and operation.

The following is the current proposed approach for installing the bay water system, which was developed for purposes of examining potential environmental impacts in the EIR:

1. Based on the soil conditions at the site (young bay mud & rubble debris), directional drilling is not recommended.
2. The intake and outfall pipelines would be HDPE, placed at or just below the existing seabed, supported on plastic lumber attached the piles with 316SS hardware.
3. The outfall and intake pipelines & structures should be within the footprint of the Pier 48.
4. The inlet manifold should be placed one bent in from the pier head. The inlet screens will be in deep water, protected by the pier, and maintenance will have direct access to the screens.

5. If necessary to extend the pipeline offshore, it would likely be directly buried, which would require minor dredging and placement of rock riprap. Maintenance of the screens will be more costly and may require support piles.
6. The outfall is typically easier to install and the engineer will determine the placement and the number of duckbill diffusers.
7. The Pump Station is recommended to remain onshore or near the bulkhead. At Pier 15, a project precedent, the intake screens, pump station, secondary screens, and outfall are at one location near the outer third of the pier.
8. If secondary screening is required, it should be near the pump station.

5.3 Project Commercial Opportunity

5.3.1 Introduction to Potential Commercial Structure

An “off-balance sheet” approach is the preferred approach of the Master Developer, where the DES Developer builds, owns, and operates the CUP and provides routine and lifecycle operations and maintenance for the distribution system up to the energy transfer station in each building. The Master Developer is interested in feedback on potential commercial structures throughout this section (see Section 6.4).

The anticipated payment structure will:

- Mitigate market risk through a DES connection mandate for all properties and, to the extent feasible, phasing of the real estate development so that annual capital requirements and annual cash flows yield sufficient returns for the DES Developer.
- Obligate DES Developer to (i) design and construct the CUP according to agreed specifications; provide a security package that includes but is not limited to parent company guarantee, warranties, liquidated damages and/or holdbacks of the design and construction work; (ii) provide project financing; (iii) operate and maintain the CUP and distribution system and (iv) provide required reporting and customer service activities, and;
- Grant DES Developer the right to receive payments according to the agreed schedule at agreed rates for a number of years to be determined after substantial completion of the Project (which will include, among other things, that the CUP is available for use), under the terms and conditions negotiated by the parties.

The following table displays the potential commercial roles for the parties involved in the CUP and distribution system:

Table 10: Potential Commercial Allocations

	CUP	Distribution system
Ownership	DES Developer	Port/Nonprofit/DES Developer
Permitting	DES Developer	Master Developer/DES Developer
Site Use	DES Developer will lease from SWL	Franchise agreement/lease within public right of way
Design and construction	DES Developer	Port or Master Developer with support of DES Developer
Commissioning	DES Developer	DES Developer

	CUP	Distribution system
Financing	DES Developer	On-balance sheet taxable from Master Developer with buy-out by the Port using tax exempt CFD
Billing and Customer Service	DES Developer	n/a
Routine O&M	DES Developer	DES Developer
Lifecycle	DES Developer	DES Developer

5.3.2 Off-take Agreement

It is assumed that each individual property owner will have a retail agreement to purchase from the DES Developer, based on rates negotiated under the ESA.

Alternative Off-take Opportunities:

Master Developer is considering an energy non-profit organization to act as the single off-taker for the ESA. The goal is for this organization to help reduce counterparty credit risk for the DES Developer by buying thermal power on behalf of the property owners in Mission Rock. The DES Developer, in turn, would not have to factor the credit risk (including the ongoing costs of billings/collections) of individual customers and could accept a lower rate of return.

Master Developer is interested in discussing with the partner the viability of this option as well as other commercial structures.

5.3.3 Energy Non-Profit

The Master Developer is interested in establishing a non-profit that could perform all or some of the following roles as they relate to the Project:

- **Rates Negotiation:** The non-profit entity would help to reduce counterparty credit risk for the DES Developer by buying thermal power, and would negotiate rates for Mission Rock property owners.
- **Ownership:** The non-profit could own the distribution system and contract the O&M to the DES Developer. The nonprofit could also own the full DES System, or to secure a credit enhancement for the full system from the Port.
- **Financing:** The non-profit could be used to secure conduit financing for the distribution system or the CUP.

The Master Developer would set up this organization, with it or the Port acting as the credit-worthy backer. Establishment and maintenance (reporting, auditing) costs for the nonprofit are expected to be nominal for a non-charity nonprofit.

Running the nonprofit requires the establishment of a board and the election of board members. Possible board seats could include voting and non-voting members, who would meet regularly (quarterly, bi-yearly) and would determine meetings and expenditures. Such board members may include:

- Master Developer

- The Port
- Elected seats for Mission Rock property owners/customers

5.3.4 Financing

The DES Developer will be responsible for the formation of capital necessary to deliver the Project. The Master Developer does not have a preference for a specific financing structure. However, it is expected that financing for the Project will include a combination of equity and debt (bank debt, taxable and/or tax-exempt bonds).

The distribution system is to be financed on Master Developer's balance sheet, which would be eventually bought out by the Port.

Alternative Financing Opportunities:

In addition to the above, Master Developer is interested in feedback on the following possible financing options:

- The DES Developer providing upfront capital for the distribution system and the Port buying out their equity with the CFD tax exempt financing.
- A nonprofit entity providing 63-20 conduit financing (or similar) for the CUP or the distribution system.

5.3.5 Operations and Maintenance

Master Developer will include stipulations for output product availability (up-time) and other performance specifications as part of negotiations under the MOU. The DES Developer will be responsible for all operations and maintenance activities necessary to make sure that availability and performance requirements are met.

Prior to beginning output product sales, and annually thereafter, the DES Developer shall provide independent, certified calibration and operational checks of all revenue meters.

5.3.6 Billing/Customer Service

Master Developer and the DES Developer will negotiate an appropriate means and mechanism for invoicing. The DES Developer will be responsible for providing a negotiated level of customer service, inclusive of response and resolution of issues raised by Master Developer within a contractually agreed time period.

5.3.7 Entitlement and Permitting

Master Developer will be responsible for all entitlements and approvals from authorities having jurisdiction over the Project Site.

The DES Developer will be responsible for all permitting related to the CUP.

The distribution system will be a joint permitting effort between the Master Developer and the DES Developer.

DES Developer will be responsible for all ongoing permitting related to DES operations.

5.3.8 Reporting

The DES Developer will be responsible for providing all routine, periodic, and incident reporting as negotiated between the Master Developer and DES Developer.

6 REQUIREMENTS FOR THE SOQ

The following are the minimum requirements for the SOQ. Please structure your SOQ so that it mirrors the structure of this section, addressing each requirement in order.

In the Technical and Commercial Responses, the Master Developer is seeking to gain an understanding of how your Project Team would approach the Project, not on the final solutions. Technical and Commercial Responses will be subject to further negotiation and refinement post-selection when the DES Developer will be able to conduct full due diligence and determine feasibility, among other things.

Qualifications shall be prepared simply, providing a straightforward description of the Respondent's ability to meet the requirements of this RFQ. Emphasis shall be on the quality, completeness, clarity of content, responsiveness to the requirements, and an understanding of Master Developer's needs.

6.1 Proposed Project Team

- Provide a statement of interest for the Project including a narrative describing the unique qualifications of the Project Team as they pertain to the Project.
- Provide a brief history of the Prime Firm and the Prime Firm's experience in similar projects. In addition, please discuss any known limitations to the Project Team's ability to fulfill the scope as outlined herein.
- Provide resumes (limit one page each) giving the experience and expertise of the key professional members that would be working on this deal from the Prime Firm as well as for the lead for engineering, procurement and construction ("EPC") services and the lead for O&M services (together "Lead Contractor(s)"), including their experience with similar projects, the number of years with the firm, and their city of residence.
- Provide a statement on the availability and commitment of the key professionals in the Prime Firm and Lead Contractor(s) that will be assigned to the Project.

6.2 Previous Experience

- List a maximum of five (5) projects for which the Prime Firm has provided services that are most directly related to the Project. Wherever possible, provide representative projects where the proposed Prime Firm, Lead Contractor(s), lead A/E Firm and other key sub-contractors have worked together. List the projects in order of priority, with the most relevant project listed first. Provide the following information for each project listed:
 - Project name, location, contract delivery method, and description.
 - Color images (photographic or machine reproductions).
 - Final Construction Cost, including Change Orders.
 - Final Project size in gross square feet; Final Project power and thermal capacity.
 - Type of construction (new, renovation, or expansion).
 - Actual start and finish dates for design.
 - Actual Notice to Proceed and Substantial Completion dates for construction.
 - Description of professional services Prime Firm and contractors provided for the project.

- Name of Project Manager (individual responsible to the System/University for the overall success of the project).
 - Sources of funding/financing.
- Provide references for each project listed above, identify the following:
 - The Owner's name and representative who served as the day-to-day liaison during the design and construction, and O&M phases of the Project, including name, title, telephone number and email.
 - Contractor's name and representative who served as the day-to-day liaison during the pre-construction and/or construction phase of the project, including name, title, telephone number and email.
 - Length of business relationship with the owner.

References shall be considered relevant based on specific project participation and experience with the Prime Firm and/or Lead Contractor(s).

6.3 Technical Response

- Please describe generally the Project Team's suggested technical approach to the Project. In doing so, please describe how your approach would achieve stated goals and requirements of the Project listed in Sections 5.1.3 and 5.1.3 above. Highlight your experience with delivering the proposed technological solutions (e.g. from other projects preferably submitted with your SOQ). Please also include additional ideas or innovations not addressed in this RFQ.
- Describe the Project Team's approach to construction, commissioning and start-up. Please include in the narrative how the approach will take into account the phased nature of the Mission Rock development. Please specifically address the Team's approach to plant locations and any sequencing required to reach the final CUP build-out.
- Please describe the Project Team's approach to O&M. Include discussion and examples of reliability assurance, water and energy conservation practices in operations, energy efficiency practices in operations, safety practices, quality assurances, controls and monitoring approaches.

6.4 Commercial Responses

- Please describe generally the commercial structure you envisage for the Project. Provide a deal structure diagram showing key parties and major agreements. Please also address the Alternative Off-taker Opportunity and Nonprofit Opportunity mentioned in Sections 5.3.2 and 5.3.3 above and discuss what benefits and challenges these opportunities may present. Highlight your experience with the proposed commercial structure (e.g. from other projects, preferably projects submitted with your SOQ).
- Please identify the primary risks that the Project Team anticipates for the Project, categorized by Design, Construction and O&M, along with recommended mitigation measures for those risks.
- Please demonstrate the Prime Firm's ability to secure financing for the Project (i.e. as a BOO). In doing so, please state what key debt requirements you might expect given your suggested structure (e.g. gearing requirements). Please also address the Alternative Financing

Opportunities mentioned in Section 5.3.2 above. Highlight your experience with similar financings involved on projects (preferably projects submitted with your SOQ).

- Detail the DES Developer's ability and demonstrated experience in providing financing for:
 - Similar projects within specified financial closing time parameters;
 - Projects utilizing offtake agreements for multiple retail customers; and
 - Projects where you were a counterparty to single, non-profit off-taker.

6.5 Blue Sky Discussion

- Please also provide additional ideas or areas for consideration that have not been included in the scope of this RFQ.
- Please note the Master Developer may be running a separate RFQ for a water treatment system for Mission Rock. Please reach out to the Point of Contact if Respondent is interested in similarly designing, building, owning or operating a water treatment system. Respondents that are interested in this opportunity should state in this section of the SOQ the possible benefits the Master Developer and other end users might see as a result of the Project Team delivering and operating both systems jointly.

ATTACHMENT A: Draft Memorandum of Understanding

[To be released]

ATTACHMENT B: Site Plan

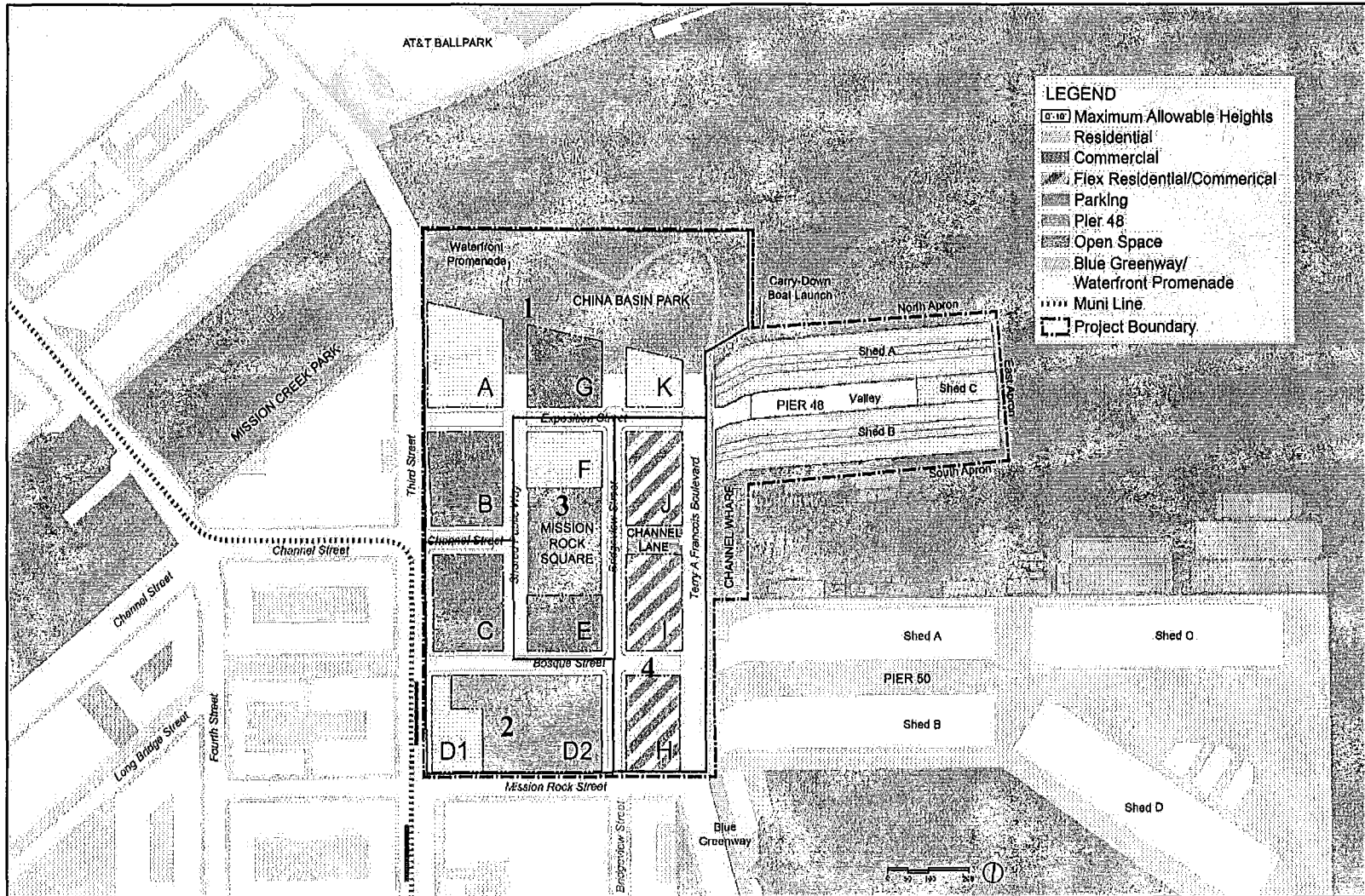

B-1

ATTACHMENT C: Draft Schematic of Planned Utilities

ATTACHMENT D: Supplementary Technical Information

D.1 Thermal Generation Details

The planning basis for the generation portion of the DES assumes:

- Centralized heat recovery chillers
- Centralized electric water cooled chillers
- Centralized low/medium temperature hot water boilers
- Plate-and-frame “free-cooling” heat exchangers (bay-water)
- Plate-and-frame “heat-rejection” heat exchangers (bay-water)
- Balance of bay-water heat rejection and cooling plant (tanks, screens, etc.)
- Cooling towers³

D.2 Distribution Details

The planning basis for the distribution portion of the DES assumes a 6-pipe system comprising of:

- Chilled water (CHW) supply and return pipes
- Heating hot water (HHW) supply and return pipes
- Bay water intake and outflow pipes

The HHW and CHW systems are assumed to be direct bury, insulated piping systems, steel for HHW and HDPE for CHW. The bay water piping is assumed to be uninsulated, direct bury steel pipe.

Distribution routing and pipe sizing will be driven by CUP location and configuration and project phasing. Right of way corridors within the project site are relatively narrow, and site roadways are pile supported to mitigate differential settlement relative to the buildings, reducing the space available for utility installation. Pipe routing and building points of connection will need to be coordinated with site and building design teams.

Representative trench sections are presented in the figures below:

³ Capacity to be limited by greater of (1) heat rejection capacity needed above 24” bay-water capacity, and (2) heat rejection requirements during scheduled bay-water system down-time

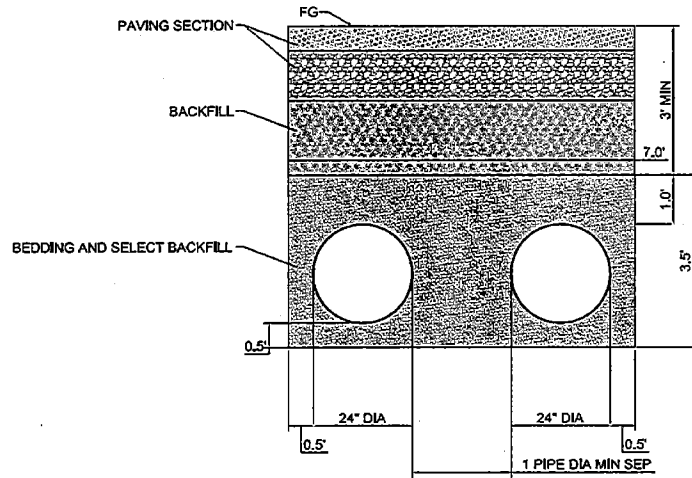

Figure 2: Typical Bay Water Intake/Outflow Section

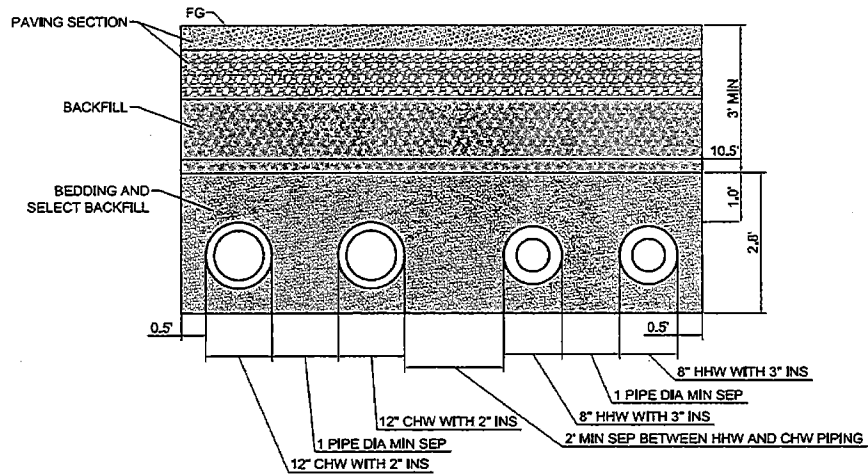

Figure 3: Chilled and Hot Water Combined Trench - Maximum Section

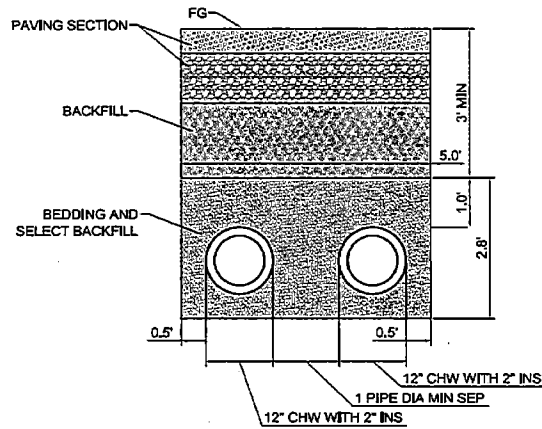

Figure 4: Chilled Water Trench - Maximum Section

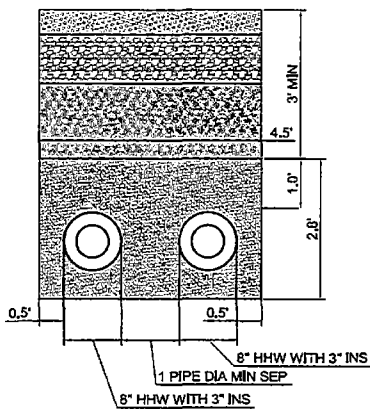

Figure 5: Heat Hot Water Trench - Maximum Section

D.3 Building Interconnections

The planning basis for the building interconnection portion of the DTES has assumed pairs of plate-and-frame heat exchangers for each of the hot water and chilled water services. As part of a partnership, the developer will be taking on the responsibility of collaborating with the vertical development team on the design, coordination, and commissioning of these systems.

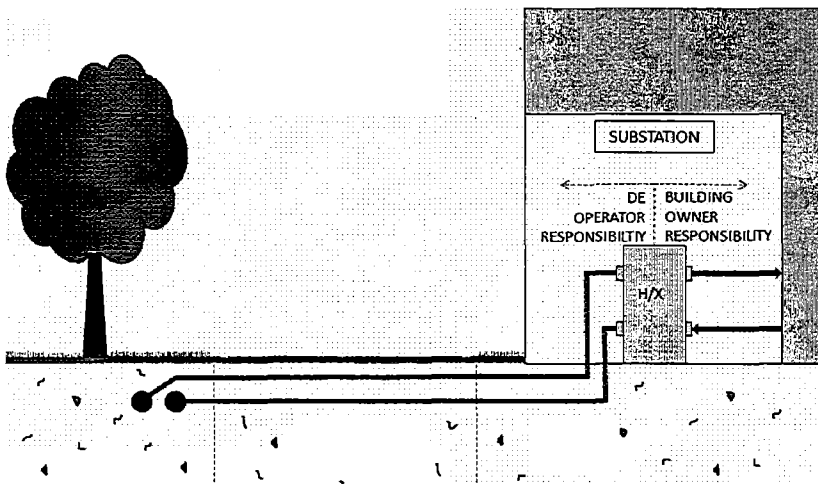

Figure 6: Substation Depiction

D.4 Anchor Brewing Process Loads

Anchor Brewing process loads account for a major portion of the site energy consumption.

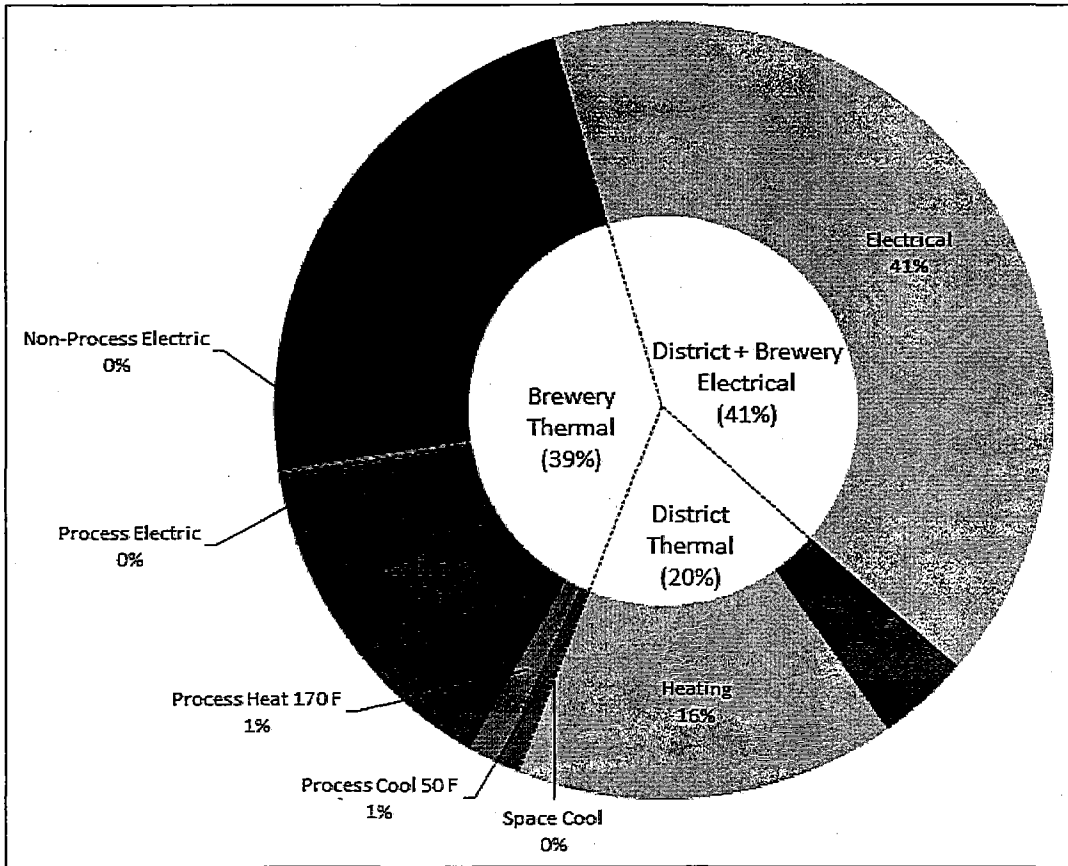

Figure 7: Ultimate Energy Consumption Split (400,000 Barrels/Year, no Brewery Efficiency)

Applying plausible levels of energy efficiency to all brewery end-uses generates the hypothetical energy consumption estimates summarized in Figure 8. This illustrates the sensitivity of the brewery energy efficiency as an input to the load estimation exercise.

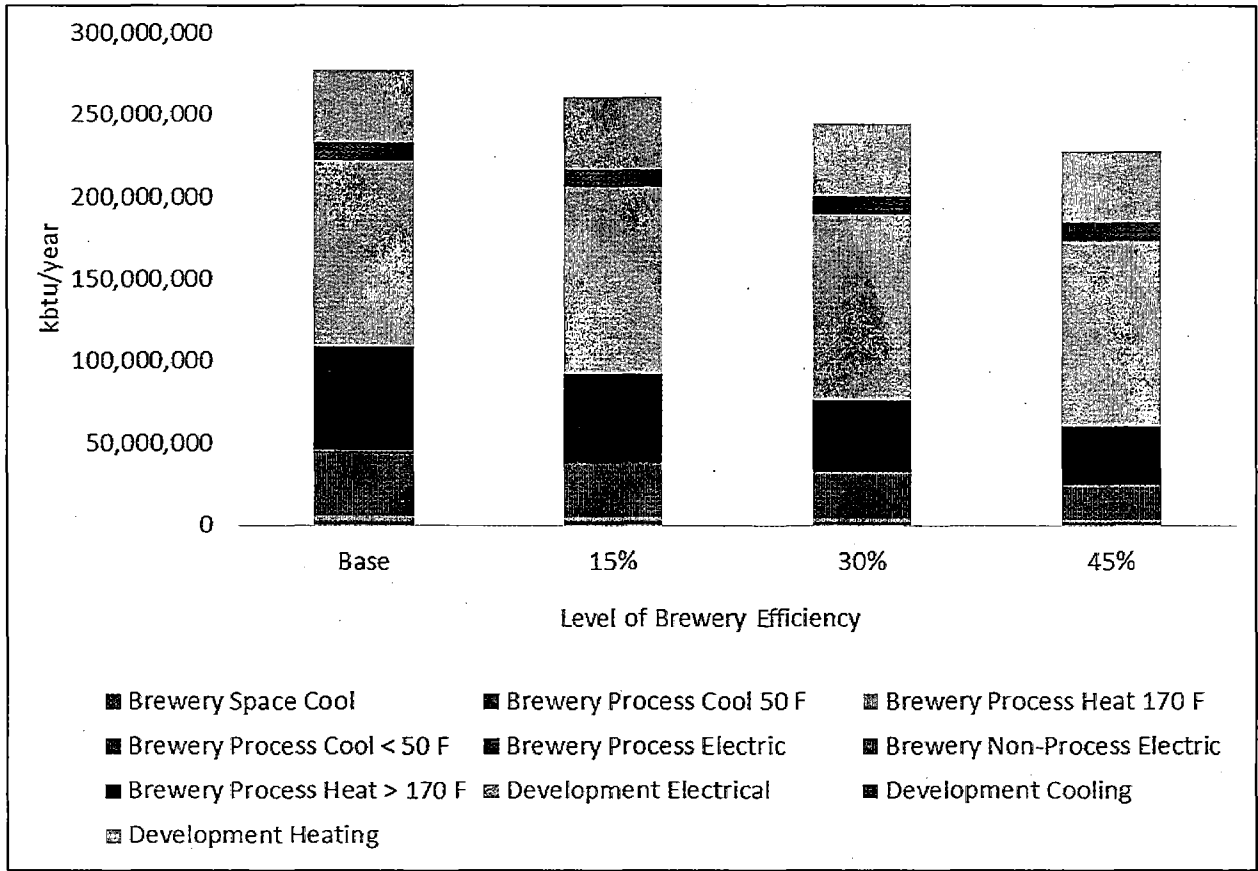

Figure 8: Hypothetical Ultimate Energy Consumption Estimates (400,000 barrels/year)

Unlike the district, the Anchor brewing process entails several high-temperature, steam, and low-temperature chilled water loads as illustrated in Figure 9.

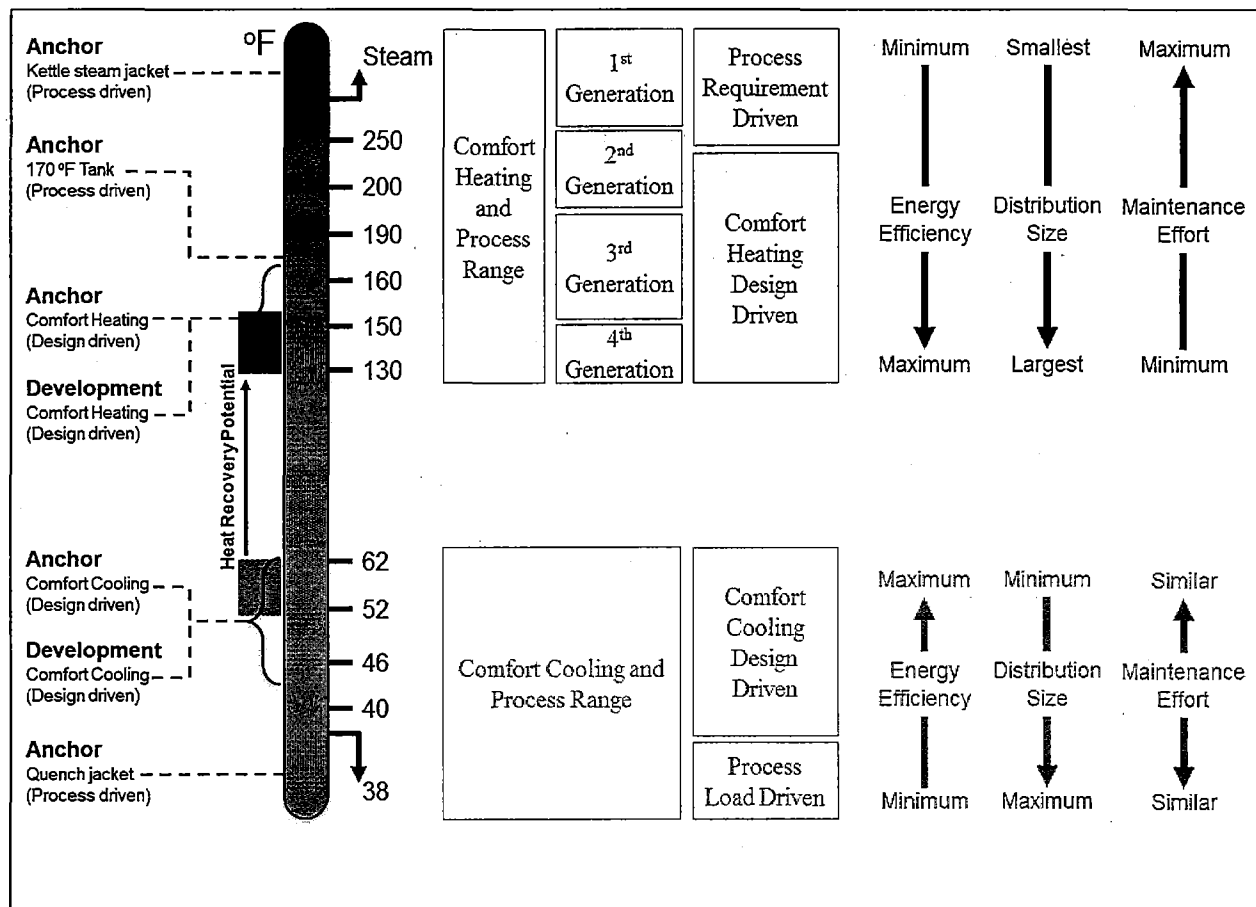

Figure 9: Development Thermal Load Map

It is not thermodynamically efficient to aggregate and supply these significantly different load categories from a single plant, or to overproduce steam or low-temperature chilled water to serve low-temperature heating and elevated chilled water cooling loads respectively.

Anchor Brewing has indicated that the brewing process, loads, and therefore the process plant requirements will continue to be updated as of and after the publication of this RFQ.

For these reasons, the current approach is to site the Anchor Brewing process plant as close as possible to the loads it serves (i.e. on Pier 48), and not over-size it to additionally serve the Project Site (or a portion thereof).

There may be opportunities to pre-heat the Anchor Brewing process hot water using the district heating system and distribution. This might be achievable under a scenario where an extensive distribution run from the closest main branch is not required, and could be beneficial if a significant resulting reduction in the Anchor brewing plant (essentially steam boiler capacity) can be achieved.

ATTACHMENT E: Assumptions

Given the early planning nature of this work, Arup developed and shared a series of technical assumptions during the 2013 feasibility study. These assumptions were approved for planning purposes, and are being carried forward for purposes of a reference design in the RFQ. These assumptions are tabulated below.

Standard Office Cooling EUI	Energy Utilization Intensities	1.3	kbtu/sq.ft./year
Standard Office Heating EUI	Energy Utilization Intensities	9.5	kbtu/sq.ft./year
Standard Office Electric EUI	Energy Utilization Intensities	41.3	kbtu/sq.ft./year
Biotech Office Cooling EUI	Energy Utilization Intensities	15.3	kbtu/sq.ft./year
Biotech Office Heating EUI	Energy Utilization Intensities	10.9	kbtu/sq.ft./year
Biotech Office Electric EUI	Energy Utilization Intensities	89.3	kbtu/sq.ft./year
Residential Cooling EUI	Energy Utilization Intensities	1.4	kbtu/sq.ft./year
Residential Heating EUI	Energy Utilization Intensities	23.2	kbtu/sq.ft./year
Residential Electric EUI	Energy Utilization Intensities	22.20	kbtu/sq.ft./year
Retail Cooling EUI	Energy Utilization Intensities	7.6	kbtu/sq.ft./year
Retail Heating EUI	Energy Utilization Intensities	5.0	kbtu/sq.ft./year
Retail Electric EUI	Energy Utilization Intensities	54.5	kbtu/sq.ft./year
Brewery Space Heating EUI	Energy Utilization Intensities	0.1	kbtu/sq.ft./year
Brewery Space Cool EUI	Energy Utilization Intensities	3.6	kbtu/sq.ft./year
Brewery Process Electric EUI	Energy Utilization Intensities	36	kbtu/barrel/year
Brewery Non-Process Electric EUI	Energy Utilization Intensities	18	kbtu/barrel/year
Brewery Process Heat > 170 F EUI	Energy Utilization Intensities	190	kbtu/barrel/year
Brewery Process Heat 170 F EUI	Energy Utilization Intensities	10	kbtu/barrel/year
Brewery Process Cool > 50 F EUI	Energy Utilization Intensities	26.6	kbtu/barrel/year
Brewery Process cool < 50 F EUI	Energy Utilization Intensities	145	kbtu/barrel/year
BAU Cooling Efficiency	Avg. Annual Equipment Efficiencies	0.55	kW/Ton
BAU Heating Efficiency	Avg. Annual Equipment Efficiencies	80%	%
BAU Electric Efficiency	Avg. Annual Equipment Efficiencies	99%	%
Vapor Compression Chillers	Avg. Annual Equipment Efficiencies	0.364	kW/Ton
Absorption Chillers	Avg. Annual Equipment Efficiencies	1	COP
Organic Refrigerant Chillers	Avg. Annual Equipment Efficiencies	0.70	kW/Ton

Gas Hot Water Boilers	Avg. Annual Equipment Efficiencies	82%	%
CHP/CCHP Thermal Efficiency	Avg. Annual Equipment Efficiencies	41.6%	%
CHP/CCHP Electrical Efficiency	Avg. Annual Equipment Efficiencies	45.1%	%
CHP/CCHP Max Turndown	Avg. Annual Equipment Efficiencies	85%	%
CHP/CCHP Max Heat Dumping	Avg. Annual Equipment Efficiencies	15%	%
Electric Only Fuel Cell Thermal Efficiency	Avg. Annual Equipment Efficiencies	51.7%	%
Electric Only Fuel Cell Electrical Efficiency	Avg. Annual Equipment Efficiencies	20%	%
Heat Recovery Chillers	Avg. Annual Equipment Efficiencies	0.60	kW/Ton
Cooling Towers	Avg. Annual Equipment Efficiencies	0.053	kW/Ton
Heat Dump Radiators	Avg. Annual Equipment Efficiencies	0.106	kW/Ton
Vapor Compression Chiller w/ Deep Lake Condenser Water	Avg. Annual Equipment Efficiencies	0.35	kW/Ton
Heat Recovery Chiller w/ Deep Lake Condenser Water	Avg. Annual Equipment Efficiencies	0.59	kW/Ton
Anchor Steam Existing Steam Boiler Plant	Avg. Annual Equipment Efficiencies	65%	%
New Steam Boiler Plant	Avg. Annual Equipment Efficiencies	78%	%
CHW Network Thermal Efficiency	DE Network Thermal Efficiencies	97.0%	%
HHW Network Thermal Efficiency	DE Network Thermal Efficiencies	95.5%	%
CW Network Thermal Efficiency	DE Network Thermal Efficiencies	98.0%	%
Pump Efficiency	District Pumping Efficiency	80%	%
Motor Efficiency	District Pumping Efficiency	90%	%
Average Network Pressure Head	District Pumping Efficiency	1.75	ft./100 ft.
CHW Design Supply T	Chilled Water Network Parameters	50	F
CHW Design Cooling Delta T	Chilled Water Network Parameters	13	F
CHW Total Network Length	Chilled Water Network Parameters	3,680	ft.
CHW Heat Exchanger Pressure Drop	Chilled Water Network Parameters	15	ft.
CHW Valves, Fittings, Bends Loss	Chilled Water Network Parameters	40%	% of Total Straight Pipe Loss
HHW Design Heating Delta T	Heating Hot Water Network Parameters	35	F
HHW Total Network Length	Heating Hot Water Network Parameters	3,680	ft.
HHW Heat Exchanger Pressure Drop	Heating Hot Water Network Parameters	15	ft.
HHW Valves, Fittings, Bends Loss	Heating Hot Water Network Parameters	40%	% of Total Straight Pipe Loss
CW Design Cooling Delta T	Condenser Water Network Parameters	15	F
CW Total Network Length	Condenser Water Network Parameters	3,680	ft.

CW Heat Exchanger Pressure Drop	Condenser Water Network Parameters	15	ft.
CW Valves, Fittings, Bends Loss	Condenser Water Network Parameters	40%	% of Total Straight Pipe Loss
Reversible Heat Pump Cooling Efficiency	Avg. Annual Equipment Efficiencies	0.711	kW/Ton
Reversible Heat Pump Heating Efficiency	Avg. Annual Equipment Efficiencies	0.708	kW/Ton
Reversible Heat Pump - Cooling with Colder Bay/River Water	Avg. Annual Equipment Efficiencies	0.675	kW/Ton
Bay Water Flow rate (Heat Rejection)	Bay Water Heat Rejection Parameters	3	gpm/ton
Bay Water Pump Efficiency (Heat Rejection)	Bay Water Heat Rejection Parameters	80%	%
Bay Water Pump Motor Efficiency (Heat Rejection)	Bay Water Heat Rejection Parameters	90%	%
Bay Water Network Length (Heat Rejection)	Bay Water Heat Rejection Parameters	4,000	ft.
Bay Water Average Network Pressure Head (Heat Rejection)	Bay Water Heat Rejection Parameters	1.75	ft./100 ft.
Bay Water Design Delta T (Heat Rejection)	Bay Water Heat Rejection Parameters	10	F
Bay Water Heat Exchanger Pressure Drop (Heat Rejection)	Bay Water Heat Rejection Parameters	15	ft.
Bay Water Valves, Fittings, Bends Loss (Heat Rejection)	Bay Water Heat Rejection Parameters	40%	% of Total Straight Pipe Loss
Bay Water Flow rate (Cooling)	Bay Water Cooling Parameters	2	gpm/ton
Bay Water Pump Efficiency (Cooling)	Bay Water Cooling Parameters	80%	%
Bay Water Pump Motor Efficiency (Cooling)	Bay Water Cooling Parameters	90%	%
Bay Water Network Length (Cooling)	Bay Water Cooling Parameters	8,000	ft.
Bay Water Average Network Pressure Head (Cooling)	Bay Water Cooling Parameters	1.75	ft./100 ft.
Bay Water Design Delta T (Cooling)	Bay Water Cooling Parameters	13	F
Bay Water Heat Exchanger Pressure Drop (Cooling)	Bay Water Cooling Parameters	15	ft.
Bay Water Valves, Fittings, Bends Loss (Cooling)	Bay Water Cooling Parameters	40%	% of Total Straight Pipe Loss
Residential Cooling Load Density	Space Cooling Load Densities	700	sq.ft./Ton
Retail Cooling Load Density	Space Cooling Load Densities	350	sq.ft./Ton
Commercial Cooling Load Density	Space Cooling Load Densities	400	sq.ft./Ton
Brewery Cooling Load Density	Space Cooling Load Densities	400	sq.ft./Ton
Residential Heating Load Density	Space Heating Load Densities	10	btu/h/sq.ft.
Retail Heating Load Density	Space Heating Load Densities	20	btu/h/sq.ft.
Commercial Heating Load Density	Space Heating Load Densities	15	btu/h/sq.ft.
Brewery Heating Load Density	Space Heating Load Densities	5	btu/h/sq.ft.

Nominal Heating Plant Efficiency (Sizing)	Nominal Equipment Efficiencies	85%	%
Bay Minimum Winter Temperature	Bay Water Cooling Parameters	48	F
Bay Maximum Summer Temperature	Bay Water Cooling Parameters	70	F
Parking Structure Conditioning		Unconditioned	Conditioned/ Unconditioned
Branch Pipe Sizing Criteria	Chilled Water Network Parameters	7	fps
Main Pipe Sizing Criteria	Chilled Water Network Parameters	10	fps